

VQ COOLSTAR

KESİLMESİ ZOR MALZEMELERİN YÜKSEK VERİMLİLİKLE İŞLENMESİ İÇİN BİRDEN ÇOK İÇTEN SOĞUTMA DELİKLERİNE SAHİP PARMAK FREZE SERİSİ

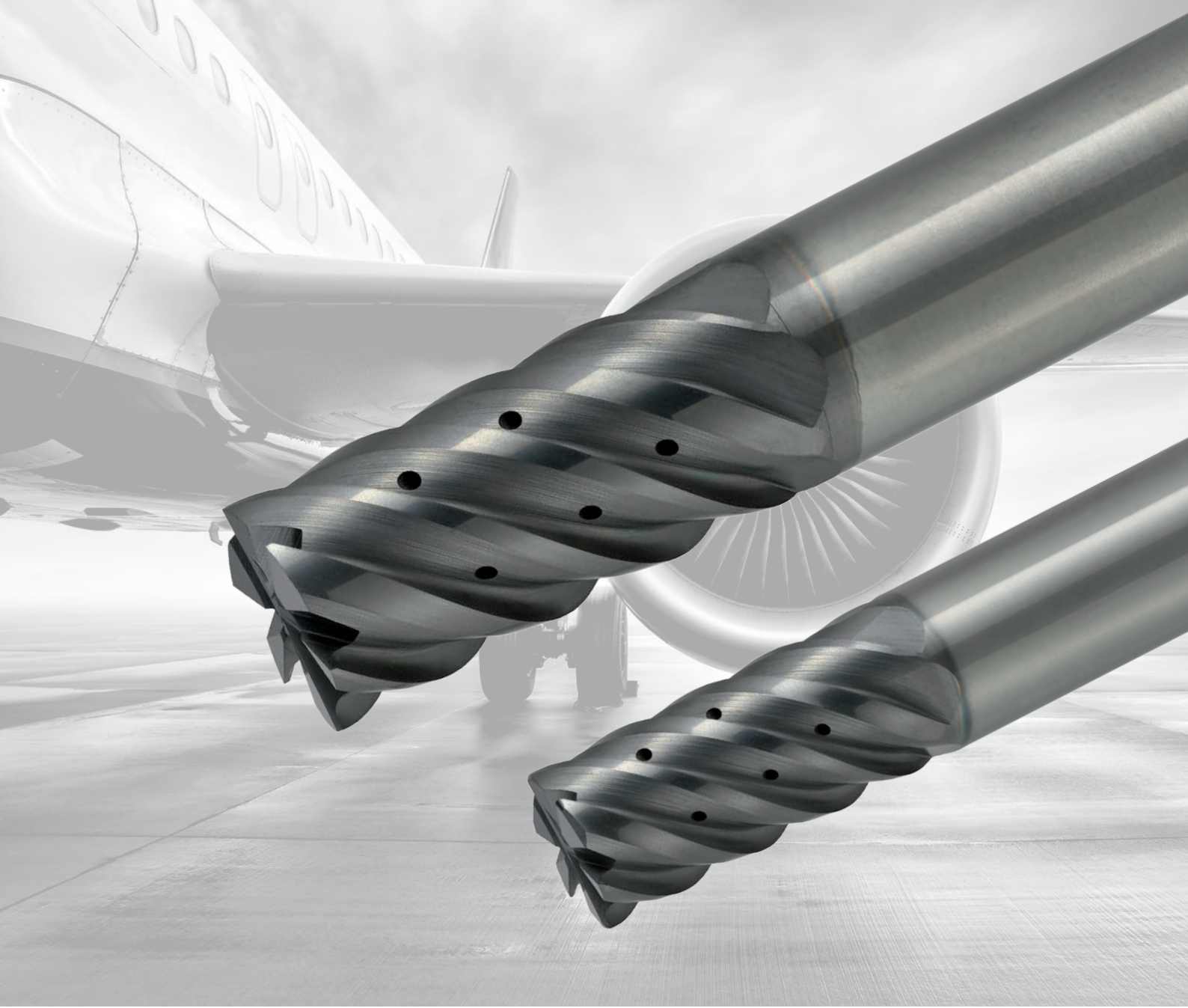

DIAEDGE

 **MITSUBISHI MATERIALS**

COOLSTAR SERİSİ

HAVACILIK VE UZAY SANAYİ'İNDE KULLANILAN
TİTANYUM VE PASLANMAZ ÇELİK KOMPONENTLERİN
ETKİLİ İŞLENMESİ İÇİN PARMAK FREZE

KAPLAMA TEKNOLOJİSİ

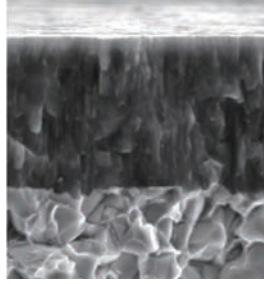

Pürüzsüz yüzey teknolojisi
"SIFIR- μ Yüzey"

Yeni geliştirilmiş
(Al, Cr)N grubu kaplama

Süper ince parçacıklı,
süper sert alt yapı malzemesi

ÇOK SAYIDA İÇTEN SOĞUTMA SIVISI DELİKLERİ

Çok sayıda içten soğutma sıvısı sistemi, kaynak direncini artırmak için kullanılır. Soğutma sıvısı deliklerinin spiral düzeni birden çok işleme uygulamalarına olanak sağlar. Özellikle kesilmesi zor malzemelerin işlenmesi için uygundur ve istikrarlı işleme olanağı sunar.

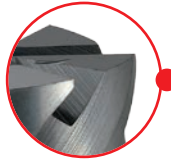

VQ6MHVCH

DC 10 – 20 mm

Kesme boyu orta uzunlukta, 6 ağızlı, düzensiz helisel kanallı, çoklu içten soğutma delikli Parmak freze

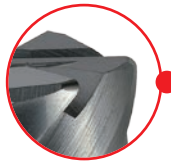

VQ6MHVRBCH

DC 10 – 20 mm
RE 0,5 – 4 mm

Kesme boyu uzunluğu orta, 6 ağızlı, düzensiz helisel kanallı, çoklu içten soğutma delikli, köşe radyuslu parmak freze

VQ6MHVCH



M S

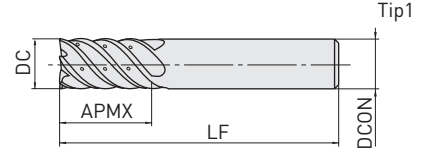

	DC≤12	DC>12		
	0	0		
	- 0.020	- 0.030		
	DCON=10	DCON=12	DCON=16	DCON=20
	0	0	0	0
	- 0.009	- 0.011	- 0.011	- 0.013

Sipariş Numarası	DC	APMX	LF	DCON	Ağız sayısı	Stok	Tip
VQ6MHVCHD1000	10	22	70	10	6	●	1
VQ6MHVCHD1200	12	26	75	12	6	●	1
VQ6MHVCHD1600	16	32	90	16	6	●	1
VQ6MHVCHD2000	20	38	100	20	6	●	1

VQ6MHVRBCH



M S

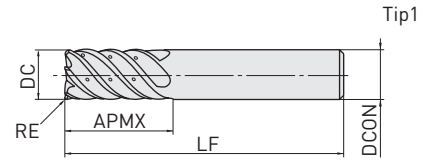

	0.5≤RE≤4			
	±0.015			
	DC≤12	DC>12		
	0	0		
	- 0.020	- 0.030		
	DCON=10	DCON=12	DCON=16	DCON=20
	0	0	0	0
	- 0.009	- 0.011	- 0.011	- 0.013

Sipariş Numarası	DC	RE	APMX	LF	DCON	Ağız sayısı	Stok	Tip
VQ6MHVRBCHD1000R050	10	0.5	22	70	10	6	●	1
VQ6MHVRBCHD1000R100	10	1	22	70	10	6	●	1
VQ6MHVRBCHD1200R050	12	0.5	26	75	12	6	●	1
VQ6MHVRBCHD1200R100	12	1	26	75	12	6	●	1
VQ6MHVRBCHD1600R100	16	1	32	90	16	6	●	1
VQ6MHVRBCHD1600R300	16	3	32	90	16	6	●	1
VQ6MHVRBCHD1600R400	16	4	32	90	16	6	●	1
VQ6MHVRBCHD2000R100	20	1	38	100	20	6	●	1
VQ6MHVRBCHD2000R300	20	3	38	100	20	6	●	1
VQ6MHVRBCHD2000R400	20	4	38	100	20	6	●	1

●: Standart stok.

ÖNERİLEN KESME KOŞULLARI

Köşe Frezeleme

Malzeme	M		S	
	n (min ⁻¹)	Vf (mm/min)	n (min ⁻¹)	Vf (mm/min)
Ostenitli Paslanmaz Çelik (<200HB), Titanyum Alaşımları DIN X5CrNi189, DIN X5CrNiMo1810, Ti-6Al-4V			Isıya Dirençli Alaşımlar Inconel 718	
DC	n (min ⁻¹)	Vf (mm/min)	n (min ⁻¹)	Vf (mm/min)
10	4800	2000	1300	260
12	4000	2000	1100	230
16	3000	1600	800	180
20	2400	1400	640	150

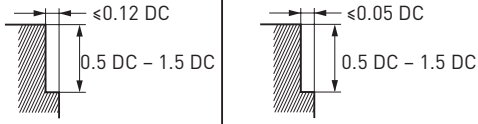

Trokoidal Frezeleme

Malzeme	M	
	n (min ⁻¹)	Vf (mm/min)
Ostenitli Paslanmaz Çelik (<200HB), Titanyum Alaşımları DIN X5CrNi189, DIN X5CrNiMo1810, Ti-6Al-4V		
DC	n (min ⁻¹)	Vf (mm/min)
10	4800	1400
12	4000	1200
16	3000	1100
20	2400	900

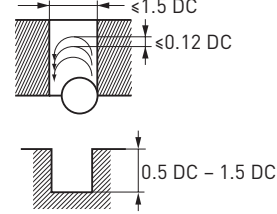

1. Kesme derinliği düşükse, devir ve ilerleme hızı artırılabilir.
2. Düzensiz helis kanallı parmak freze, standart parmak frezelere kıyasla titreşimi kontrol etmekte daha büyük etkiye sahiptir. Ancak, tezgahın veya iş parçasının bağlama rijitliği yetersizse, titreşim meydana gelebilir. Bu durumda, lütfen devri ve ilerleme oranını orantısız şekilde ayarlayın.

MITSUBISHI MATERIALS CORPORATION

www.mitsubishicarbide.com | www.mmc-hardmetal.com

GERMANY

MMC HARTMETALL GMBH
Comeniusstr. 2 . 40670 Meerbusch
Phone +49 2159 91890 . Fax +49 2159 918966
Email admin@mmchg.de

U.K.

MMC HARDMETAL U.K. LTD.
Mitsubishi House . Galena Close . Tamworth . Staffs. B77 4AS
Phone +44 1827 312312 . Fax +44 1827 312314
Email sales@mitsubishicarbide.co.uk

SPAIN

MITSUBISHI MATERIALS ESPAÑA, S.A.
Calle Emperador 2 . 46136 Museros/Valencia
Phone +34 96 1441711 . Fax +34 96 1443786
Email mme@mmvalencia.com

FRANCE

MMC METAL FRANCE S.A.R.L.
6, Rue Jacques Monod . 91400 Orsay
Phone +33 1 69 35 53 53 . Fax +33 1 69 35 53 50
Email mmsales@mmc-metal-france.fr

POLAND

MMC HARDMETAL POLAND SP. Z O.O
Al. Armii Krajowej 61 . 50 - 541 Wrocław
Phone +48 71335 1620 . Fax +48 71335 1621
Email sales@mitsubishicarbide.com.pl

RUSSIA

MMC HARDMETAL RUSSIA OOO LTD.
Electrozavodskaya Str. 24 . build. 3 107023 Moscow
Phone +7 495 7255885 . Fax +7 495 9813979
Email info@mmc-carbide.ru

ITALY

MMC ITALIA S.R.L.
Via Montefeltro 6/A . 20156 Milano
Phone +39 0293 77031 . Fax +39 0293 589093
Email info@mmc-italia.it

TURKEY

MMC HARTMETALL GMBH ALMANYA - İZMİR MERKEZ ŞUBESİ
Adalet Mahallesi Anadolu Caddesi No: 41-1 . 15001 35580
Bayraklı / İzmir
Phone +90 232 5015000 . Fax +90 232 5015007
Email info@mmchg.com.tr

Sipariş Kodu: B247TR 

Yayın Tarihi: 2017.09 [0.8 DP], Almanya'da basılmıştır