MPS1

HOCHLEISTUNGS-VOLLHARTMETALLBOHRER



MPS1

HOCHLEISTUNGS-VOLLHARTMETALLBOHRER



LxDC 3 – 8

STABILE SCHNEIDKANTE

Für das Hochleistungsbohren



LxDC 10 – 40
LxDC 2 (PC)

OPTIMIERTE GEOMETRIE

Für das Tieflochbohren mit optimaler Bohrlochqualität

DP1021

Neue ALTiCrN-PVD-Beschichtung sorgt für hohe Standzeiten auch unter extremen Schnittparametern.

PRÄZISION

Die doppelten Führungsfasen erzielen eine hohe Oberflächenqualität der Bohrung.



- Erhöhter Kühlmitteldurchfluss
- Optimierte Schmierung
- Schnellere Spanabfuhr

STABILITÄT (CAE-ANALYSE)

Der extralange Vollhartmetallbohrer MPS1 wurde konzipiert, um eine ca. 20 % höhere Kraft gegen Durchbiegung bei gleichzeitiger Optimierung des Kerndurchmessers und Spiralwinkels zu erzielen.

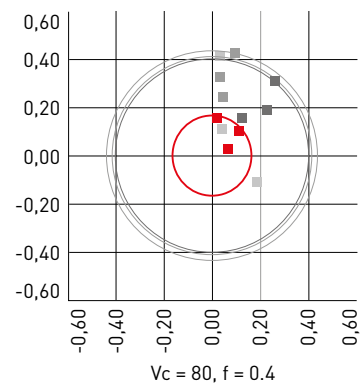
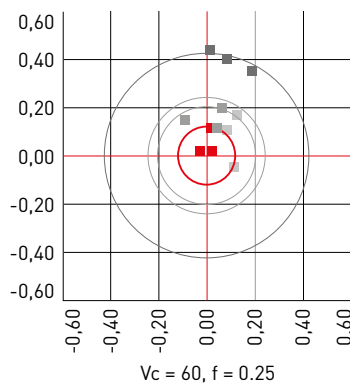

- Mitsubishi Materials Werkzeug
- Herkömmlich A
- Herkömmlich B
- Herkömmlich C

ANWENDUNGSBEISPIELE

PRÜFUNG DER WERKZEUGSTANDZEIT Ø 8 MM UNTER DEM EINSATZ VON NORMALEN SCHNITTDATEN

| | |
|----------------|--|
| Material | DIN C50 |
| Bohrtiefe (mm) | 40 |
| Vc (m/min) | 120 |
| f (mm/U) | 0.25 |
| Kühlung | Emulsion |
| Maschine | Vertikales BZ |
| Ergebnis | Enorme Standzeitverbesserung durch den MPS1-Bohrer um +250 % |

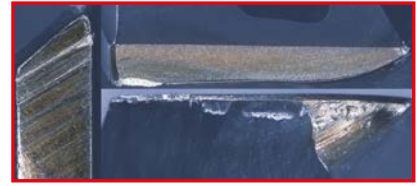
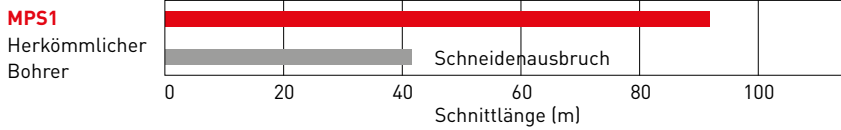

MPS1



Herkömmlich

PRÜFUNG DER WERKZEUGSTANDZEIT Ø 8 MM UNTER DEM EINSATZ VON HOHEN SCHNITTDATEN

| | |
|----------------|--|
| Material | DIN C50 |
| Bohrtiefe (mm) | 40 |
| Vc (m/min) | 200 |
| f (mm/U) | 0.35 |
| Kühlung | Emulsion |
| Maschine | Vertikales BZ. |
| Ergebnis | Enorme Standzeitverbesserung durch den MPS1-Bohrer bei hohen Schnittparametern |

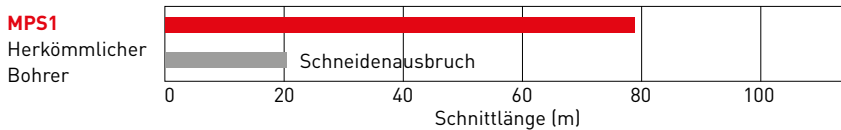

MPS1



Herkömmlich

TIEFLOCHBOHRER

DURCHGEHENDE ZENTRIERBOHRUNG

| | |
|----------------|---|
| Werkzeug | MPS1-0380-L12C |
| Material | 115MnPb30 |
| Bohrtiefe (mm) | 45 (12 l/d) |
| Vc (m/min) | 75 |
| f (mm/U) | 0.135 |
| Maschine | Maschine mit Spindelstock |
| Ergebnis | Die Standzeit des MPS1 war um 36 % länger |

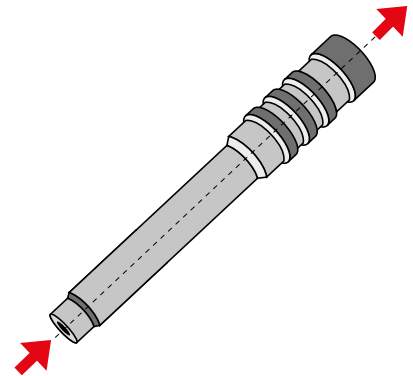
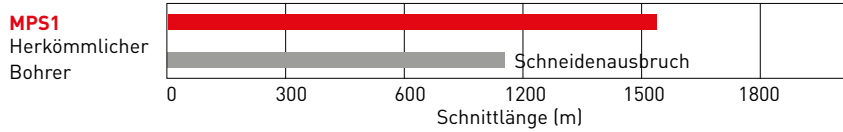

KÜHLKANALBOHRUNG

| | |
|----------------|--|
| Werkzeug | MPS1-0800-L30C |
| Material | CR7 V-L (Stahl für die Kaltarbeit, 1130 N/mm ²) |
| Bohrtiefe (mm) | 250 (30 l/d) |
| Vc (m/min) | 120 |
| f (mm/U) | 0.35 |
| Maschine | Horizontales Bearbeitungszentrum |
| Ergebnis | Die Standzeit des MPS1 war 2 mal länger, axiale Geradheit der Bohrung weniger als 0,15 mm Abweichung |

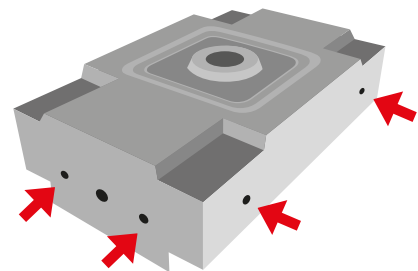
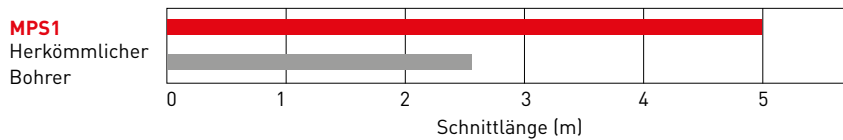

MPS1

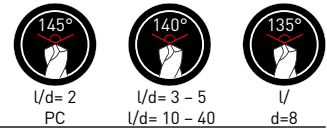

VOLLHARTMETALLBOHRER



1 Zylindrischer Schaft mit konischem Hinterschliff

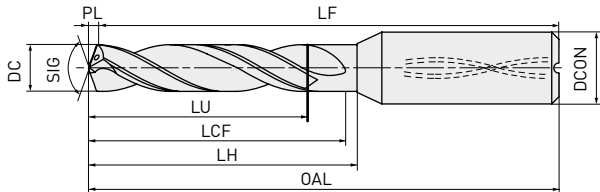

MPS1----S/L-DIN-C/L8C -L40C

2 Zylindrischer Schaft

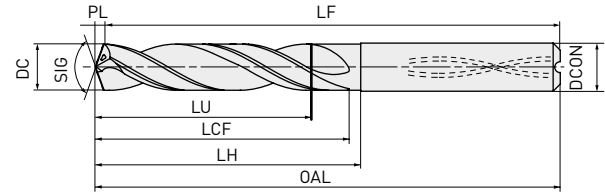

MPS1----S/L-DIN-C/L8C -L40C

3 Whistle-Notch-Schaft mit konischem Hinterschliff

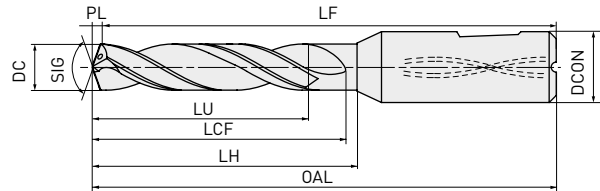

MPS1----S/L-DIN (Whistle-Notch)

4 Whistle-Notch-Schaft

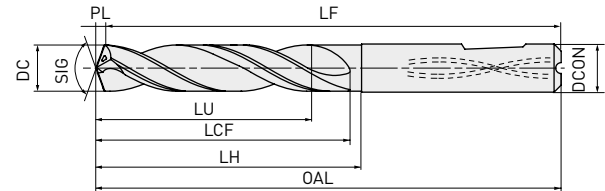

MPS1----S/L-DIN (Whistle-Notch)

- Die Kühlmittelbohrungen bei Bohrern in S-DIN(C) & L-DIN(C) & L8C haben bis Schneidendurchmesser DC 6 mm oder weniger eine runde Form. Die Kühlmittelbohrungen bei Bohrern von L10C bis L40C haben bis Schneidendurchmesser DC 4,9mm, oder weniger eine runde Form.
- SIG : l/d 3 – 5 und 10 – 40 = 140°, 8 = 135°, PC = 145°



| | 3≤DC≤6 | 6<DC≤10 | 10<DC≤18 | 18<DC≤20 |
|------------------------------|------------------|------------------|------------------|------------------|
| DC Toleranz (DIN/PC) (mm) | +0.010 -0.002 | +0.010 -0.005 | +0.005 -0.013 | +0.005 -0.016 |
| DC Toleranz (L_C) (mm) | 0 -0.012 | 0 -0.015 | 0 -0.018 | 0 -0.021 |
| DCON Toleranz (mm) | 0 -0.008 | 0 -0.009 | 0 -0.011 | 0 -0.013 |

| Bestellnummer | DC | (l/d) | OAL | LU | LCF | LH | LF | PL | DCON | DP1021 | Typ |
|------------------|----|-------|-----|-------|-------|-------|------|-----|------|--------|-----|
| MPS1-0300S-DIN | 3 | 3 | 62 | 15.0 | 20 | 26 | 61.5 | 0.5 | 6 | □ | 3 |
| MPS1-0300S-DIN-C | | 3 | 62 | 15.0 | 20 | 26 | 61.5 | 0.5 | 6 | ● | 1 |
| MPS1-0300L-DIN | | 5 | 66 | 20.0 | 25 | 30 | 65.5 | 0.5 | 6 | □ | 3 |
| MPS1-0300L-DIN-C | | 5 | 66 | 20.0 | 25 | 30 | 65.5 | 0.5 | 6 | ● | 1 |
| MPS1-0300-PC | | 2 | 55 | 6.5 | 16.5 | 19.22 | 55 | 0.5 | 6 | ● | 1 |
| MPS1-0300-L8C | | 8 | 77 | 24.6 | 34 | 41 | 76 | 0.5 | 6 | ● | 1 |
| MPS1-0300-L10C | | 10 | 80 | 30.5 | 37.5 | 43 | 79 | 0.5 | 6 | ● | 1 |
| MPS1-0300-L12C | | 12 | 86 | 36.5 | 43.5 | 49 | 85 | 0.5 | 6 | ● | 1 |
| MPS1-0300-L15C | | 15 | 95 | 45.5 | 52.5 | 58 | 94 | 0.5 | 6 | ● | 1 |
| MPS1-0300-L20C | | 20 | 110 | 60.5 | 67.5 | 73 | 109 | 0.5 | 6 | ● | 1 |
| MPS1-0300-L25C | | 25 | 125 | 75.5 | 82.5 | 88 | 124 | 0.5 | 6 | ● | 1 |
| MPS1-0300-L30C | | 30 | 140 | 90.5 | 97.5 | 103 | 139 | 0.5 | 6 | ● | 1 |
| MPS1-0300-L35C | | 35 | 159 | 105.5 | 113.5 | 122 | 158 | 0.5 | 6 | □ | 1 |
| MPS1-0300-L40C | | 40 | 174 | 120.5 | 128.5 | 137 | 173 | 0.5 | 6 | ● | 1 |

● : Lagerstandard. ★ : Lagerstandard in Japan.

□ : Herstellung nur auf Anfrage.

MPS1

VOLLHARTMETALLBOHRER

| Bestellnummer | DC | (l/d) | OAL | LU | LCF | LH | LF | PL | DCON | DP1021 | Typ | |
|------------------|------|-------|-----|-------|-------|-------|------|------|------|--------|-----|---|
| MPS1-0305S-DIN | 3.05 | 3 | 62 | 15.0 | 20 | 26 | 61.4 | 0.6 | 6 | □ | 3 | |
| MPS1-0305S-DIN-C | | 3 | 62 | 15.0 | 20 | 26 | 61.4 | 0.6 | 6 | ● | 1 | |
| MPS1-0305L-DIN | | 5 | 66 | 20.0 | 25 | 30 | 65.4 | 0.6 | 6 | □ | 3 | |
| MPS1-0305L-DIN-C | | 5 | 66 | 20.0 | 25 | 30 | 65.4 | 0.6 | 6 | ● | 1 | |
| MPS1-0310S-DIN | 3.1 | 3 | 62 | 14.9 | 20 | 26 | 61.4 | 0.6 | 6 | □ | 3 | |
| MPS1-0310S-DIN-C | | 3 | 62 | 14.9 | 20 | 26 | 61.4 | 0.6 | 6 | ● | 1 | |
| MPS1-0310L-DIN | | 5 | 66 | 19.9 | 25 | 30 | 65.4 | 0.6 | 6 | □ | 3 | |
| MPS1-0310L-DIN-C | | 5 | 66 | 19.9 | 25 | 30 | 65.4 | 0.6 | 6 | ● | 1 | |
| MPS1-0310-PC | | 2 | 55 | 6.7 | 18.5 | 21.11 | 55 | 0.5 | 6 | ● | 1 | |
| MPS1-0310-L8C | | 8 | 83 | 25.4 | 40 | 47 | 82 | 0.6 | 6 | ● | 1 | |
| MPS1-0310-L10C | | 10 | 87 | 31.6 | 44.6 | 50 | 86 | 0.6 | 6 | □ | 1 | |
| MPS1-0310-L12C | | 12 | 94 | 37.8 | 51.6 | 57 | 93 | 0.6 | 6 | ● | 1 | |
| MPS1-0310-L15C | | 15 | 104 | 47.1 | 61.6 | 67 | 103 | 0.6 | 6 | ● | 1 | |
| MPS1-0310-L20C | | 20 | 122 | 62.6 | 79.6 | 85 | 121 | 0.6 | 6 | ● | 1 | |
| MPS1-0310-L25C | | 25 | 139 | 78.1 | 96.6 | 102 | 138 | 0.6 | 6 | ● | 1 | |
| MPS1-0310-L30C | | 30 | 157 | 93.6 | 114.6 | 120 | 156 | 0.6 | 6 | ● | 1 | |
| MPS1-0310-L35C | | 35 | 176 | 109.1 | 123.6 | 139 | 175 | 0.6 | 6 | □ | 1 | |
| MPS1-0310-L40C | | 40 | 191 | 124.6 | 138.6 | 154 | 190 | 0.6 | 6 | ● | 1 | |
| MPS1-0320S-DIN | | 3.2 | 3 | 62 | 14.8 | 20 | 26 | 61.4 | 0.6 | 6 | □ | 3 |
| MPS1-0320S-DIN-C | | | 3 | 62 | 14.8 | 20 | 26 | 61.4 | 0.6 | 6 | ● | 1 |
| MPS1-0320L-DIN | 5 | | 66 | 19.8 | 25 | 30 | 65.4 | 0.6 | 6 | □ | 3 | |
| MPS1-0320L-DIN-C | 5 | | 66 | 19.8 | 25 | 30 | 65.4 | 0.6 | 6 | ● | 1 | |
| MPS1-0320-PC | 2 | | 56 | 6.9 | 18.5 | 22 | 55 | 0.5 | 6 | ● | 1 | |
| MPS1-0320-L8C | 8 | | 83 | 26.3 | 40 | 47 | 82 | 0.6 | 6 | ● | 1 | |
| MPS1-0320-L10C | 10 | | 87 | 32.6 | 44.6 | 50 | 86 | 0.6 | 6 | □ | 1 | |
| MPS1-0320-L12C | 12 | | 94 | 39 | 51.6 | 57 | 93 | 0.6 | 6 | ● | 1 | |
| MPS1-0320-L15C | 15 | | 104 | 48.6 | 61.6 | 67 | 103 | 0.6 | 6 | ● | 1 | |
| MPS1-0320-L20C | 20 | | 122 | 64.6 | 79.6 | 85 | 121 | 0.6 | 6 | ● | 1 | |
| MPS1-0320-L25C | 25 | | 139 | 80.6 | 96.6 | 102 | 138 | 0.6 | 6 | ● | 1 | |
| MPS1-0320-L30C | 30 | | 157 | 96.6 | 114.6 | 120 | 156 | 0.6 | 6 | ● | 1 | |
| MPS1-0320-L35C | 35 | | 176 | 112.6 | 123.6 | 139 | 175 | 0.6 | 6 | □ | 1 | |
| MPS1-0320-L40C | 40 | | 191 | 128.6 | 138.6 | 154 | 190 | 0.6 | 6 | ● | 1 | |
| MPS1-0330S-DIN | 3.3 | | 3 | 62 | 14.7 | 20 | 26 | 61.4 | 0.6 | 6 | □ | 3 |
| MPS1-0330S-DIN-C | | | 3 | 62 | 14.7 | 20 | 26 | 61.4 | 0.6 | 6 | ● | 1 |
| MPS1-0330L-DIN | | 5 | 66 | 20.2 | 25 | 30 | 65.4 | 0.6 | 6 | □ | 3 | |
| MPS1-0330L-DIN-C | | 5 | 66 | 20.2 | 25 | 30 | 65.4 | 0.6 | 6 | ● | 1 | |
| MPS1-0330-PC | | 2 | 56 | 7.1 | 18.5 | 21.9 | 55 | 0.5 | 6 | ● | 1 | |
| MPS1-0330-L8C | | 8 | 83 | 27.1 | 40 | 47 | 82 | 0.6 | 6 | ● | 1 | |
| MPS1-0330-L10C | | 10 | 87 | 33.6 | 44.6 | 50 | 86 | 0.6 | 6 | □ | 1 | |
| MPS1-0330-L12C | | 12 | 94 | 40.2 | 51.6 | 57 | 93 | 0.6 | 6 | ● | 1 | |
| MPS1-0330-L15C | | 15 | 104 | 50.1 | 61.6 | 67 | 103 | 0.6 | 6 | ● | 1 | |
| MPS1-0330-L20C | | 20 | 122 | 66.6 | 79.6 | 85 | 121 | 0.6 | 6 | ● | 1 | |
| MPS1-0330-L25C | | 25 | 139 | 83.1 | 96.6 | 102 | 138 | 0.6 | 6 | ● | 1 | |
| MPS1-0330-L30C | | 30 | 157 | 99.6 | 114.6 | 120 | 156 | 0.6 | 6 | ● | 1 | |
| MPS1-0330-L35C | | 35 | 176 | 116.1 | 132.6 | 139 | 175 | 0.6 | 6 | □ | 1 | |
| MPS1-0330-L40C | | 40 | 191 | 132.6 | 148.6 | 154 | 190 | 0.6 | 6 | ● | 1 | |

MPS1

VOLLHARTMETALLBOHRER

| Bestellnummer | DC | (l/d) | OAL | LU | LCF | LH | LF | PL | DCON | DP1021 | Typ |
|------------------|-----|-------|-----|-------|-------|-------|------|-----|------|--------|-----|
| MPS1-0340S-DIN | 3.4 | 3 | 62 | 14.5 | 20 | 26 | 61.4 | 0.6 | 6 | □ | 3 |
| MPS1-0340S-DIN-C | | 3 | 62 | 14.5 | 20 | 26 | 61.4 | 0.6 | 6 | ● | 1 |
| MPS1-0340L-DIN | | 5 | 66 | 20.0 | 25 | 30 | 65.4 | 0.6 | 6 | □ | 3 |
| MPS1-0340L-DIN-C | | 5 | 66 | 20.0 | 25 | 30 | 65.4 | 0.6 | 6 | ● | 1 |
| MPS1-0340-PC | | 2 | 56 | 7.3 | 18.5 | 21.79 | 55 | 0.5 | 6 | ● | 1 |
| MPS1-0340-L8C | | 8 | 83 | 27.9 | 40 | 47 | 82 | 0.6 | 6 | ● | 1 |
| MPS1-0340-L10C | | 10 | 87 | 34.6 | 44.6 | 50 | 86 | 0.6 | 6 | □ | 1 |
| MPS1-0340-L12C | | 12 | 94 | 41.4 | 51.6 | 57 | 93 | 0.6 | 6 | ● | 1 |
| MPS1-0340-L15C | | 15 | 104 | 51.6 | 61.6 | 67 | 103 | 0.6 | 6 | ● | 1 |
| MPS1-0340-L20C | | 20 | 122 | 68.6 | 79.6 | 85 | 121 | 0.6 | 6 | ● | 1 |
| MPS1-0340-L25C | | 25 | 139 | 85.6 | 96.6 | 102 | 138 | 0.6 | 6 | ● | 1 |
| MPS1-0340-L30C | | 30 | 157 | 102.6 | 114.6 | 120 | 156 | 0.6 | 6 | ● | 1 |
| MPS1-0340-L35C | | 35 | 176 | 119.6 | 132.6 | 139 | 175 | 0.6 | 6 | □ | 1 |
| MPS1-0340-L40C | | 40 | 191 | 136.6 | 148.6 | 154 | 190 | 0.6 | 6 | ● | 1 |
| MPS1-0350S-DIN | 3.5 | 3 | 62 | 14.4 | 20 | 26 | 61.4 | 0.6 | 6 | □ | 3 |
| MPS1-0350S-DIN-C | | 3 | 62 | 14.4 | 20 | 26 | 61.4 | 0.6 | 6 | ● | 1 |
| MPS1-0350L-DIN | | 5 | 66 | 19.9 | 25 | 30 | 65.4 | 0.6 | 6 | □ | 3 |
| MPS1-0350L-DIN-C | | 5 | 66 | 19.9 | 25 | 30 | 65.4 | 0.6 | 6 | ● | 1 |
| MPS1-0350-PC | | 2 | 56 | 7.6 | 18.6 | 21.68 | 55 | 0.6 | 6 | ● | 1 |
| MPS1-0350-L8C | | 8 | 83 | 28.7 | 40 | 47 | 82 | 0.6 | 6 | ● | 1 |
| MPS1-0350-L10C | | 10 | 87 | 35.6 | 44.6 | 50 | 86 | 0.6 | 6 | □ | 1 |
| MPS1-0350-L12C | | 12 | 94 | 42.6 | 51.6 | 57 | 93 | 0.6 | 6 | ● | 1 |
| MPS1-0350-L15C | | 15 | 104 | 53.1 | 61.6 | 67 | 103 | 0.6 | 6 | ● | 1 |
| MPS1-0350-L20C | | 20 | 122 | 70.6 | 79.6 | 85 | 121 | 0.6 | 6 | ● | 1 |
| MPS1-0350-L25C | | 25 | 139 | 88.1 | 96.6 | 102 | 138 | 0.6 | 6 | ● | 1 |
| MPS1-0350-L30C | | 30 | 157 | 105.6 | 114.6 | 120 | 156 | 0.6 | 6 | ● | 1 |
| MPS1-0350-L35C | | 35 | 176 | 123.1 | 132.6 | 139 | 175 | 0.6 | 6 | □ | 1 |
| MPS1-0350-L40C | | 40 | 191 | 140.6 | 148.6 | 154 | 190 | 0.6 | 6 | ● | 1 |
| MPS1-0360S-DIN | 3.6 | 3 | 62 | 14.3 | 20 | 26 | 61.3 | 0.7 | 6 | □ | 3 |
| MPS1-0360S-DIN-C | | 3 | 62 | 14.3 | 20 | 26 | 61.3 | 0.7 | 6 | ● | 1 |
| MPS1-0360L-DIN | | 5 | 66 | 19.8 | 25 | 30 | 65.3 | 0.7 | 6 | □ | 3 |
| MPS1-0360L-DIN-C | | 5 | 66 | 19.8 | 25 | 30 | 65.3 | 0.7 | 6 | ● | 1 |
| MPS1-0360-PC | | 2 | 56 | 7.8 | 20.6 | 23.57 | 55 | 0.6 | 6 | ● | 1 |
| MPS1-0360-L8C | | 8 | 88 | 29.5 | 45 | 51 | 87 | 0.7 | 6 | ● | 1 |
| MPS1-0360-L10C | | 10 | 93 | 36.7 | 50.7 | 56 | 92 | 0.7 | 6 | □ | 1 |
| MPS1-0360-L12C | | 12 | 101 | 43.9 | 58.7 | 64 | 100 | 0.7 | 6 | ● | 1 |
| MPS1-0360-L15C | | 15 | 113 | 54.7 | 70.7 | 76 | 112 | 0.7 | 6 | ● | 1 |
| MPS1-0360-L20C | | 20 | 133 | 72.7 | 90.7 | 96 | 132 | 0.7 | 6 | ● | 1 |
| MPS1-0360-L25C | | 25 | 153 | 90.7 | 110.7 | 116 | 152 | 0.7 | 6 | □ | 1 |
| MPS1-0360-L30C | | 30 | 173 | 108.7 | 130.7 | 136 | 172 | 0.7 | 6 | ● | 1 |
| MPS1-0360-L35C | | 35 | 193 | 126.7 | 143.7 | 156 | 192 | 0.7 | 6 | □ | 1 |
| MPS1-0360-L40C | | 40 | 213 | 144.7 | 160.7 | 176 | 212 | 0.7 | 6 | ● | 1 |

MPS1

VOLLHARTMETALLBOHRER

| Bestellnummer | DC | (l/d) | OAL | LU | LCF | LH | LF | PL | DCON | DP1021 | Typ |
|------------------|-----|-------|-----|-------|-------|-------|------|-----|------|--------|-----|
| MPS1-0370S-DIN | 3.7 | 3 | 62 | 14.1 | 20 | 26 | 61.3 | 0.7 | 6 | □ | 3 |
| MPS1-0370S-DIN-C | | 3 | 62 | 14.1 | 20 | 26 | 61.3 | 0.7 | 6 | ● | 1 |
| MPS1-0370L-DIN | | 5 | 66 | 20.1 | 26 | 30 | 65.3 | 0.7 | 6 | □ | 3 |
| MPS1-0370L-DIN-C | | 5 | 66 | 20.1 | 26 | 30 | 65.3 | 0.7 | 6 | ● | 1 |
| MPS1-0370-PC | | 2 | 56 | 8 | 20.6 | 23.47 | 55 | 0.6 | 6 | ● | 1 |
| MPS1-0370-L8C | | 8 | 88 | 30.4 | 45 | 51 | 87 | 0.7 | 6 | ● | 1 |
| MPS1-0370-L10C | | 10 | 93 | 37.7 | 50.7 | 56 | 92 | 0.7 | 6 | □ | 1 |
| MPS1-0370-L12C | | 12 | 101 | 45.1 | 58.7 | 64 | 100 | 0.7 | 6 | ● | 1 |
| MPS1-0370-L15C | | 15 | 113 | 56.2 | 70.7 | 76 | 112 | 0.7 | 6 | ● | 1 |
| MPS1-0370-L20C | | 20 | 133 | 74.7 | 90.7 | 96 | 132 | 0.7 | 6 | ● | 1 |
| MPS1-0370-L25C | | 25 | 153 | 93.2 | 110.7 | 116 | 152 | 0.7 | 6 | ● | 1 |
| MPS1-0370-L30C | | 30 | 173 | 111.7 | 130.7 | 136 | 172 | 0.7 | 6 | ● | 1 |
| MPS1-0370-L35C | | 35 | 193 | 130.2 | 143.7 | 156 | 192 | 0.7 | 6 | □ | 1 |
| MPS1-0370-L40C | | 40 | 213 | 148.7 | 160.7 | 176 | 212 | 0.7 | 6 | ● | 1 |
| MPS1-0380S-DIN | 3.8 | 3 | 66 | 18.0 | 24 | 30 | 65.3 | 0.7 | 6 | □ | 3 |
| MPS1-0380S-DIN-C | | 3 | 66 | 18.0 | 24 | 30 | 65.3 | 0.7 | 6 | ● | 1 |
| MPS1-0380L-DIN | | 5 | 74 | 28.0 | 34 | 38 | 73.3 | 0.7 | 6 | □ | 3 |
| MPS1-0380L-DIN-C | | 5 | 74 | 28.0 | 34 | 38 | 73.3 | 0.7 | 6 | ● | 1 |
| MPS1-0380-PC | | 2 | 56 | 8.2 | 20.6 | 23.36 | 55 | 0.6 | 6 | ● | 1 |
| MPS1-0380-L8C | | 8 | 88 | 31.2 | 45 | 51 | 87 | 0.7 | 6 | ● | 1 |
| MPS1-0380-L10C | | 10 | 93 | 38.7 | 50.7 | 56 | 92 | 0.7 | 6 | □ | 1 |
| MPS1-0380-L12C | | 12 | 101 | 46.3 | 58.7 | 64 | 100 | 0.7 | 6 | ● | 1 |
| MPS1-0380-L15C | | 15 | 113 | 57.7 | 70.7 | 76 | 112 | 0.7 | 6 | ● | 1 |
| MPS1-0380-L20C | | 20 | 133 | 76.7 | 90.7 | 96 | 132 | 0.7 | 6 | ● | 1 |
| MPS1-0380-L25C | | 25 | 153 | 95.7 | 110.7 | 116 | 152 | 0.7 | 6 | ● | 1 |
| MPS1-0380-L30C | | 30 | 173 | 114.7 | 130.7 | 136 | 172 | 0.7 | 6 | ● | 1 |
| MPS1-0380-L35C | | 35 | 193 | 133.7 | 150.7 | 156 | 192 | 0.7 | 6 | □ | 1 |
| MPS1-0380-L40C | | 40 | 213 | 152.7 | 170.7 | 176 | 212 | 0.7 | 6 | ● | 1 |
| MPS1-0390S-DIN | 3.9 | 3 | 66 | 17.9 | 24 | 30 | 65.3 | 0.7 | 6 | □ | 3 |
| MPS1-0390S-DIN-C | | 3 | 66 | 17.9 | 24 | 30 | 65.3 | 0.7 | 6 | ● | 1 |
| MPS1-0390L-DIN | | 5 | 74 | 27.9 | 34 | 38 | 73.3 | 0.7 | 6 | □ | 3 |
| MPS1-0390L-DIN-C | | 5 | 74 | 27.9 | 34 | 38 | 73.3 | 0.7 | 6 | ● | 1 |
| MPS1-0390-PC | | 2 | 56 | 8.4 | 20.6 | 23.25 | 55 | 0.6 | 6 | ● | 1 |
| MPS1-0390-L8C | | 8 | 88 | 32.0 | 45 | 51 | 87 | 0.7 | 6 | ● | 1 |
| MPS1-0390-L10C | | 10 | 93 | 39.7 | 50.7 | 56 | 92 | 0.7 | 6 | □ | 1 |
| MPS1-0390-L12C | | 12 | 101 | 47.5 | 58.7 | 64 | 100 | 0.7 | 6 | ● | 1 |
| MPS1-0390-L15C | | 15 | 113 | 59.2 | 70.7 | 76 | 112 | 0.7 | 6 | ● | 1 |
| MPS1-0390-L20C | | 20 | 133 | 78.7 | 90.7 | 96 | 132 | 0.7 | 6 | ● | 1 |
| MPS1-0390-L25C | | 25 | 153 | 98.2 | 110.7 | 116 | 152 | 0.7 | 6 | □ | 1 |
| MPS1-0390-L30C | | 30 | 173 | 117.7 | 130.7 | 136 | 172 | 0.7 | 6 | ● | 1 |
| MPS1-0390-L35C | | 35 | 193 | 137.2 | 150.7 | 156 | 192 | 0.7 | 6 | □ | 1 |
| MPS1-0390-L40C | | 40 | 213 | 156.7 | 170.7 | 176 | 212 | 0.7 | 6 | ● | 1 |

MPS1

VOLLHARTMETALLBOHRER

| Bestellnummer | DC | (l/d) | OAL | LU | LCF | LH | LF | PL | DCON | DP1021 | Typ |
|------------------|------|-------|-----|-------|-------|-------|------|-----|------|--------|-----|
| MPS1-0400S-DIN | 4 | 3 | 66 | 17.7 | 24 | 30 | 65.3 | 0.7 | 6 | □ | 3 |
| MPS1-0400S-DIN-C | | 3 | 66 | 17.7 | 24 | 30 | 65.3 | 0.7 | 6 | ● | 1 |
| MPS1-0400L-DIN | | 5 | 74 | 27.7 | 34 | 38 | 73.3 | 0.7 | 6 | □ | 3 |
| MPS1-0400L-DIN-C | | 5 | 74 | 27.7 | 34 | 38 | 73.3 | 0.7 | 6 | ● | 1 |
| MPS1-0400-PC | | 2 | 56 | 8.6 | 20.6 | 23.14 | 55 | 0.6 | 6 | ● | 1 |
| MPS1-0400-L8C | | 8 | 88 | 32.8 | 45 | 51 | 87 | 0.7 | 6 | ● | 1 |
| MPS1-0400-L10C | | 10 | 93 | 40.7 | 50.7 | 56 | 92 | 0.7 | 6 | ● | 1 |
| MPS1-0400-L12C | | 12 | 101 | 48.7 | 58.7 | 64 | 100 | 0.7 | 6 | ● | 1 |
| MPS1-0400-L15C | | 15 | 113 | 60.7 | 70.7 | 76 | 112 | 0.7 | 6 | ● | 1 |
| MPS1-0400-L20C | | 20 | 133 | 80.7 | 90.7 | 96 | 132 | 0.7 | 6 | ● | 1 |
| MPS1-0400-L25C | | 25 | 153 | 100.7 | 110.7 | 116 | 152 | 0.7 | 6 | ● | 1 |
| MPS1-0400-L30C | | 30 | 173 | 120.7 | 130.7 | 136 | 172 | 0.7 | 6 | ● | 1 |
| MPS1-0400-L35C | | 35 | 193 | 140.7 | 150.7 | 156 | 192 | 0.7 | 6 | □ | 1 |
| MPS1-0400-L40C | | 40 | 213 | 160.7 | 170.7 | 176 | 212 | 0.7 | 6 | ● | 1 |
| MPS1-0405S-DIN | 4.05 | 3 | 66 | 17.7 | 24 | 30 | 65.3 | 0.7 | 6 | □ | 3 |
| MPS1-0405S-DIN-C | | 3 | 66 | 17.7 | 24 | 30 | 65.3 | 0.7 | 6 | ● | 1 |
| MPS1-0405L-DIN | | 5 | 74 | 27.7 | 34 | 38 | 73.3 | 0.7 | 6 | □ | 3 |
| MPS1-0405L-DIN-C | | 5 | 74 | 27.7 | 34 | 38 | 73.3 | 0.7 | 6 | ● | 1 |
| MPS1-0410S-DIN | 4.1 | 3 | 66 | 17.6 | 24 | 30 | 65.3 | 0.7 | 6 | □ | 3 |
| MPS1-0410S-DIN-C | | 3 | 66 | 17.6 | 24 | 30 | 65.3 | 0.7 | 6 | ● | 1 |
| MPS1-0410L-DIN | | 5 | 74 | 27.6 | 34 | 38 | 73.3 | 0.7 | 6 | □ | 3 |
| MPS1-0410L-DIN-C | | 5 | 74 | 27.6 | 34 | 38 | 73.3 | 0.7 | 6 | ● | 1 |
| MPS1-0410-PC | | 2 | 63 | 8.8 | 22.6 | 25.04 | 62 | 0.6 | 6 | ● | 1 |
| MPS1-0410-L8C | | 8 | 93 | 33.6 | 51 | 56 | 92 | 0.7 | 6 | ● | 1 |
| MPS1-0410-L10C | | 10 | 100 | 41.7 | 58.7 | 63 | 99 | 0.7 | 6 | □ | 1 |
| MPS1-0410-L12C | | 12 | 109 | 49.9 | 67.7 | 72 | 108 | 0.7 | 6 | ● | 1 |
| MPS1-0410-L15C | | 15 | 122 | 62.2 | 80.7 | 85 | 121 | 0.7 | 6 | ● | 1 |
| MPS1-0410-L20C | | 20 | 145 | 82.7 | 103.7 | 108 | 144 | 0.7 | 6 | ● | 1 |
| MPS1-0410-L25C | | 25 | 167 | 103.2 | 125.7 | 130 | 166 | 0.7 | 6 | ● | 1 |
| MPS1-0410-L30C | | 30 | 190 | 123.7 | 148.7 | 153 | 189 | 0.7 | 6 | ● | 1 |
| MPS1-0410-L35C | | 35 | 212 | 144.2 | 164.7 | 175 | 211 | 0.7 | 6 | □ | 1 |
| MPS1-0410-L40C | | 40 | 236 | 164.7 | 184.7 | 199 | 235 | 0.7 | 6 | ● | 1 |
| MPS1-0420S-DIN | 4.2 | 3 | 66 | 17.5 | 24 | 30 | 65.2 | 0.8 | 6 | □ | 3 |
| MPS1-0420S-DIN-C | | 3 | 66 | 17.5 | 24 | 30 | 65.2 | 0.8 | 6 | ● | 1 |
| MPS1-0420L-DIN | | 5 | 74 | 28.0 | 34 | 38 | 73.2 | 0.8 | 6 | □ | 3 |
| MPS1-0420L-DIN-C | | 5 | 74 | 28.0 | 34 | 38 | 73.2 | 0.8 | 6 | ● | 1 |
| MPS1-0420-PC | | 2 | 63 | 9.1 | 22.7 | 24.93 | 62 | 0.7 | 6 | ● | 1 |
| MPS1-0420-L8C | | 8 | 93 | 34.5 | 51 | 56 | 92 | 0.8 | 6 | ● | 1 |
| MPS1-0420-L10C | | 10 | 100 | 42.8 | 58.8 | 63 | 99 | 0.8 | 6 | □ | 1 |
| MPS1-0420-L12C | | 12 | 109 | 51.2 | 67.8 | 72 | 108 | 0.8 | 6 | ● | 1 |
| MPS1-0420-L15C | | 15 | 122 | 63.8 | 80.8 | 85 | 121 | 0.8 | 6 | ● | 1 |
| MPS1-0420-L20C | | 20 | 145 | 84.8 | 103.8 | 108 | 144 | 0.8 | 6 | ● | 1 |
| MPS1-0420-L25C | | 25 | 167 | 105.8 | 125.8 | 130 | 166 | 0.8 | 6 | ● | 1 |
| MPS1-0420-L30C | | 30 | 190 | 126.8 | 148.8 | 153 | 189 | 0.8 | 6 | ● | 1 |
| MPS1-0420-L35C | | 35 | 212 | 147.8 | 164.8 | 175 | 211 | 0.8 | 6 | ● | 1 |
| MPS1-0420-L40C | | 40 | 236 | 168.8 | 184.8 | 199 | 235 | 0.8 | 6 | ● | 1 |

MPS1

VOLLHARTMETALLBOHRER

| Bestellnummer | DC | (l/d) | OAL | LU | LCF | LH | LF | PL | DCON | DP1021 | Typ |
|------------------|-----|-------|-----|-------|-------|-------|------|------|------|--------|-----|
| MPS1-0430S-DIN | 4.3 | 3 | 66 | 17.3 | 24 | 30 | 65.2 | 0.8 | 6 | □ | 3 |
| MPS1-0430S-DIN-C | | 3 | 66 | 17.3 | 24 | 30 | 65.2 | 0.8 | 6 | ● | 1 |
| MPS1-0430L-DIN | | 5 | 74 | 27.8 | 34 | 38 | 73.2 | 0.8 | 6 | □ | 3 |
| MPS1-0430L-DIN-C | | 5 | 74 | 27.8 | 34 | 38 | 73.2 | 0.8 | 6 | ● | 1 |
| MPS1-0430-PC | | 2 | 63 | 9.3 | 22.7 | 24.82 | 62 | 0.7 | 6 | ● | 1 |
| MPS1-0430-L8C | | 8 | 93 | 35.3 | 51 | 56 | 92 | 0.8 | 6 | ● | 1 |
| MPS1-0430-L10C | | 10 | 100 | 43.8 | 58.8 | 63 | 99 | 0.8 | 6 | □ | 1 |
| MPS1-0430-L12C | | 12 | 109 | 52.4 | 67.8 | 72 | 108 | 0.8 | 6 | ● | 1 |
| MPS1-0430-L15C | | 15 | 122 | 65.3 | 80.8 | 85 | 121 | 0.8 | 6 | ● | 1 |
| MPS1-0430-L20C | | 20 | 145 | 86.8 | 103.8 | 108 | 144 | 0.8 | 6 | ● | 1 |
| MPS1-0430-L25C | | 25 | 167 | 108.3 | 125.8 | 130 | 166 | 0.8 | 6 | ● | 1 |
| MPS1-0430-L30C | | 30 | 190 | 129.8 | 148.8 | 153 | 189 | 0.8 | 6 | ● | 1 |
| MPS1-0430-L35C | | 35 | 212 | 151.3 | 170.8 | 175 | 211 | 0.8 | 6 | □ | 1 |
| MPS1-0430-L40C | | 40 | 236 | 172.8 | 194.8 | 199 | 235 | 0.8 | 6 | ● | 1 |
| MPS1-0440S-DIN | | 4.4 | 3 | 66 | 17.2 | 24 | 30 | 65.2 | 0.8 | 6 | □ |
| MPS1-0440S-DIN-C | 3 | | 66 | 17.2 | 24 | 30 | 65.2 | 0.8 | 6 | ● | 1 |
| MPS1-0440L-DIN | 5 | | 74 | 27.7 | 34 | 38 | 73.2 | 0.8 | 6 | □ | 3 |
| MPS1-0440L-DIN-C | 5 | | 74 | 27.7 | 34 | 38 | 73.2 | 0.8 | 6 | ● | 1 |
| MPS1-0440-PC | 2 | | 63 | 9.5 | 22.7 | 24.72 | 62 | 0.7 | 6 | ● | 1 |
| MPS1-0440-L8C | 8 | | 93 | 36.1 | 51 | 56 | 92 | 0.8 | 6 | ● | 1 |
| MPS1-0440-L10C | 10 | | 100 | 44.8 | 58.8 | 63 | 99 | 0.8 | 6 | □ | 1 |
| MPS1-0440-L12C | 12 | | 109 | 53.6 | 67.8 | 72 | 108 | 0.8 | 6 | ● | 1 |
| MPS1-0440-L15C | 15 | | 122 | 66.8 | 80.8 | 85 | 121 | 0.8 | 6 | ● | 1 |
| MPS1-0440-L20C | 20 | | 145 | 88.8 | 103.8 | 108 | 144 | 0.8 | 6 | □ | 1 |
| MPS1-0440-L25C | 25 | | 167 | 110.8 | 125.8 | 130 | 166 | 0.8 | 6 | □ | 1 |
| MPS1-0440-L30C | 30 | | 190 | 132.8 | 148.8 | 153 | 189 | 0.8 | 6 | □ | 1 |
| MPS1-0440-L35C | 35 | | 212 | 154.8 | 170.8 | 175 | 211 | 0.8 | 6 | □ | 1 |
| MPS1-0440-L40C | 40 | | 236 | 176.8 | 194.8 | 199 | 235 | 0.8 | 6 | ● | 1 |
| MPS1-0450S-DIN | 4.5 | | 3 | 66 | 17.1 | 24 | 30 | 65.2 | 0.8 | 6 | □ |
| MPS1-0450S-DIN-C | | 3 | 66 | 17.1 | 24 | 30 | 65.2 | 0.8 | 6 | ● | 1 |
| MPS1-0450L-DIN | | 5 | 74 | 27.6 | 34 | 38 | 73.2 | 0.8 | 6 | □ | 3 |
| MPS1-0450L-DIN-C | | 5 | 74 | 27.6 | 34 | 38 | 73.2 | 0.8 | 6 | ● | 1 |
| MPS1-0450-PC | | 2 | 63 | 9.7 | 22.7 | 24.61 | 62 | 0.7 | 6 | ● | 1 |
| MPS1-0450-L8C | | 8 | 93 | 36.9 | 51 | 56 | 92 | 0.8 | 6 | ● | 1 |
| MPS1-0450-L10C | | 10 | 100 | 45.8 | 58.8 | 63 | 99 | 0.8 | 6 | □ | 1 |
| MPS1-0450-L12C | | 12 | 109 | 54.8 | 67.8 | 72 | 108 | 0.8 | 6 | ● | 1 |
| MPS1-0450-L15C | | 15 | 122 | 68.3 | 80.8 | 85 | 121 | 0.8 | 6 | ● | 1 |
| MPS1-0450-L20C | | 20 | 145 | 90.8 | 103.8 | 108 | 144 | 0.8 | 6 | ● | 1 |
| MPS1-0450-L25C | | 25 | 167 | 113.3 | 125.8 | 130 | 166 | 0.8 | 6 | ● | 1 |
| MPS1-0450-L30C | | 30 | 190 | 135.8 | 148.8 | 153 | 189 | 0.8 | 6 | ● | 1 |
| MPS1-0450-L35C | | 35 | 212 | 158.3 | 170.8 | 175 | 211 | 0.8 | 6 | □ | 1 |
| MPS1-0450-L40C | | 40 | 236 | 180.8 | 194.8 | 199 | 235 | 0.8 | 6 | ● | 1 |

MPS1

VOLLHARTMETALLBOHRER

| Bestellnummer | DC | (l/d) | OAL | LU | LCF | LH | LF | PL | DCON | DP1021 | Typ |
|------------------|------|-------|-----|-------|-------|-----|------|-----|------|--------|-----|
| MPS1-0460S-DIN | 4.6 | 3 | 66 | 16.9 | 24 | 30 | 65.2 | 0.8 | 6 | □ | 4 |
| MPS1-0460S-DIN-C | | 3 | 66 | 16.9 | 24 | 30 | 65.2 | 0.8 | 6 | ● | 2 |
| MPS1-0460L-DIN | | 5 | 74 | 28.9 | 36 | 38 | 73.2 | 0.8 | 6 | □ | 4 |
| MPS1-0460L-DIN-C | | 5 | 74 | 28.9 | 36 | 38 | 73.2 | 0.8 | 6 | ● | 2 |
| MPS1-0460-PC | | 2 | 63 | 9.9 | 24.7 | 28 | 62 | 0.7 | 6 | ● | 2 |
| MPS1-0460-L8C | | 8 | 96 | 37.8 | 55 | 59 | 95 | 0.8 | 6 | ● | 2 |
| MPS1-0460-L10C | | 10 | 106 | 46.8 | 65.8 | 69 | 105 | 0.8 | 6 | □ | 2 |
| MPS1-0460-L12C | | 12 | 116 | 56 | 75.8 | 79 | 115 | 0.8 | 6 | ● | 2 |
| MPS1-0460-L15C | | 15 | 131 | 69.8 | 90.8 | 94 | 130 | 0.8 | 6 | ● | 2 |
| MPS1-0460-L20C | | 20 | 156 | 92.8 | 115.8 | 119 | 155 | 0.8 | 6 | ● | 2 |
| MPS1-0460-L25C | | 25 | 181 | 115.8 | 140.8 | 144 | 180 | 0.8 | 6 | ● | 2 |
| MPS1-0460-L30C | | 30 | 206 | 138.8 | 165.8 | 169 | 205 | 0.8 | 6 | ● | 2 |
| MPS1-0460-L35C | | 35 | 230 | 161.8 | 184.8 | 193 | 229 | 0.8 | 6 | □ | 2 |
| MPS1-0460-L40C | | 40 | 255 | 184.8 | 204.8 | 218 | 254 | 0.8 | 6 | ● | 2 |
| MPS1-0465S-DIN | 4.65 | 3 | 66 | 16.9 | 24 | 30 | 65.2 | 0.8 | 6 | □ | 4 |
| MPS1-0465S-DIN-C | | 3 | 66 | 16.9 | 24 | 30 | 65.2 | 0.8 | 6 | ● | 2 |
| MPS1-0465L-DIN | | 5 | 74 | 28.9 | 36 | 38 | 73.2 | 0.8 | 6 | □ | 4 |
| MPS1-0465L-DIN-C | | 5 | 74 | 28.9 | 36 | 38 | 73.2 | 0.8 | 6 | ● | 2 |
| MPS1-0470S-DIN | 4.7 | 3 | 66 | 16.8 | 24 | 30 | 65.1 | 0.9 | 6 | □ | 4 |
| MPS1-0470S-DIN-C | | 3 | 66 | 16.8 | 24 | 30 | 65.1 | 0.9 | 6 | ● | 2 |
| MPS1-0470L-DIN | | 5 | 74 | 28.8 | 36 | 38 | 73.1 | 0.9 | 6 | □ | 4 |
| MPS1-0470L-DIN-C | | 5 | 74 | 28.8 | 36 | 38 | 73.1 | 0.9 | 6 | ● | 2 |
| MPS1-0470-PC | | 2 | 63 | 10.1 | 24.7 | 28 | 62 | 0.7 | 6 | ● | 2 |
| MPS1-0470-L8C | | 8 | 96 | 38.6 | 55 | 59 | 95 | 0.9 | 6 | ● | 2 |
| MPS1-0470-L10C | | 10 | 106 | 47.9 | 65.9 | 69 | 105 | 0.9 | 6 | □ | 2 |
| MPS1-0470-L12C | | 12 | 116 | 57.3 | 75.9 | 79 | 115 | 0.9 | 6 | ● | 2 |
| MPS1-0470-L15C | | 15 | 131 | 71.4 | 90.9 | 94 | 130 | 0.9 | 6 | ● | 2 |
| MPS1-0470-L20C | | 20 | 156 | 94.9 | 115.9 | 119 | 155 | 0.9 | 6 | ● | 2 |
| MPS1-0470-L25C | | 25 | 181 | 118.4 | 140.9 | 144 | 180 | 0.9 | 6 | ● | 2 |
| MPS1-0470-L30C | | 30 | 206 | 141.9 | 165.9 | 169 | 205 | 0.9 | 6 | ● | 2 |
| MPS1-0470-L35C | | 35 | 230 | 165.4 | 184.9 | 193 | 229 | 0.9 | 6 | □ | 2 |
| MPS1-0470-L40C | | 40 | 255 | 188.9 | 204.9 | 218 | 254 | 0.9 | 6 | ● | 2 |
| MPS1-0480S-DIN | 4.8 | 3 | 66 | 20.7 | 28 | 30 | 65.1 | 0.9 | 6 | □ | 4 |
| MPS1-0480S-DIN-C | | 3 | 66 | 20.7 | 28 | 30 | 65.1 | 0.9 | 6 | ● | 2 |
| MPS1-0480L-DIN | | 5 | 82 | 36.7 | 44 | 46 | 81.1 | 0.9 | 6 | □ | 4 |
| MPS1-0480L-DIN-C | | 5 | 82 | 36.7 | 44 | 46 | 81.1 | 0.9 | 6 | ● | 2 |
| MPS1-0480-PC | | 2 | 63 | 10.4 | 24.8 | 28 | 62 | 0.8 | 6 | ● | 2 |
| MPS1-0480-L8C | | 8 | 96 | 39.4 | 55 | 59 | 95 | 0.9 | 6 | ● | 2 |
| MPS1-0480-L10C | | 10 | 106 | 48.9 | 65.9 | 69 | 105 | 0.9 | 6 | □ | 2 |
| MPS1-0480-L12C | | 12 | 116 | 58.5 | 75.9 | 79 | 115 | 0.9 | 6 | ● | 2 |
| MPS1-0480-L15C | | 15 | 131 | 72.9 | 90.9 | 94 | 130 | 0.9 | 6 | ● | 2 |
| MPS1-0480-L20C | | 20 | 156 | 96.9 | 115.9 | 119 | 155 | 0.9 | 6 | ● | 2 |
| MPS1-0480-L25C | | 25 | 181 | 120.9 | 140.9 | 144 | 180 | 0.9 | 6 | ● | 2 |
| MPS1-0480-L30C | | 30 | 206 | 144.9 | 165.9 | 169 | 205 | 0.9 | 6 | ● | 2 |
| MPS1-0480-L35C | | 35 | 230 | 168.9 | 190.9 | 193 | 229 | 0.9 | 6 | □ | 2 |
| MPS1-0480-L40C | | 40 | 255 | 192.9 | 215.9 | 218 | 254 | 0.9 | 6 | ● | 2 |

MPS1

VOLLHARTMETALLBOHRER

| Bestellnummer | DC | (l/d) | OAL | LU | LCF | LH | LF | PL | DCON | DP1021 | Typ | |
|------------------|------|-------|-----|-------|-------|-------|------|------|------|--------|-----|---|
| MPS1-0490S-DIN | 4.9 | 3 | 66 | 20.5 | 28 | 30 | 65.1 | 0.9 | 6 | □ | 4 | |
| MPS1-0490S-DIN-C | | 3 | 66 | 20.5 | 28 | 30 | 65.1 | 0.9 | 6 | ● | 2 | |
| MPS1-0490L-DIN | | 5 | 82 | 36.5 | 44 | 46 | 81.1 | 0.9 | 6 | □ | 4 | |
| MPS1-0490L-DIN-C | | 5 | 82 | 36.5 | 44 | 46 | 81.1 | 0.9 | 6 | ● | 2 | |
| MPS1-0490-PC | | 2 | 63 | 10.6 | 24.8 | 28 | 62 | 0.8 | 6 | ● | 2 | |
| MPS1-0490-L8C | | 8 | 96 | 40.2 | 55 | 59 | 95 | 0.9 | 6 | ● | 2 | |
| MPS1-0490-L10C | | 10 | 106 | 49.9 | 65.9 | 69 | 105 | 0.9 | 6 | □ | 2 | |
| MPS1-0490-L12C | | 12 | 116 | 59.7 | 75.9 | 79 | 115 | 0.9 | 6 | ● | 2 | |
| MPS1-0490-L15C | | 15 | 131 | 74.4 | 90.9 | 94 | 130 | 0.9 | 6 | ● | 2 | |
| MPS1-0490-L20C | | 20 | 156 | 98.9 | 115.9 | 119 | 155 | 0.9 | 6 | □ | 2 | |
| MPS1-0490-L25C | | 25 | 181 | 123.4 | 140.9 | 144 | 180 | 0.9 | 6 | ● | 2 | |
| MPS1-0490-L30C | | 30 | 206 | 147.9 | 165.9 | 169 | 205 | 0.9 | 6 | ● | 2 | |
| MPS1-0490-L35C | | 35 | 230 | 172.4 | 190.9 | 193 | 229 | 0.9 | 6 | □ | 2 | |
| MPS1-0490-L40C | | 40 | 255 | 196.9 | 215.9 | 218 | 254 | 0.9 | 6 | ● | 2 | |
| MPS1-0500S-DIN | | 5 | 3 | 66 | 20.4 | 28 | 30 | 65.1 | 0.9 | 6 | □ | 4 |
| MPS1-0500S-DIN-C | 3 | | 66 | 20.4 | 28 | 30 | 65.1 | 0.9 | 6 | ● | 2 | |
| MPS1-0500L-DIN | 5 | | 82 | 36.4 | 44 | 46 | 81.1 | 0.9 | 6 | □ | 4 | |
| MPS1-0500L-DIN-C | 5 | | 82 | 36.4 | 44 | 46 | 81.1 | 0.9 | 6 | ● | 2 | |
| MPS1-0500-PC | 2 | | 63 | 10.8 | 24.8 | 26 | 62 | 0.8 | 6 | ● | 2 | |
| MPS1-0500-L8C | 8 | | 96 | 41.0 | 55 | 59 | 95 | 0.9 | 6 | ● | 2 | |
| MPS1-0500-L10C | 10 | | 106 | 50.9 | 65.9 | 69 | 105 | 0.9 | 6 | ● | 2 | |
| MPS1-0500-L12C | 12 | | 116 | 60.9 | 75.9 | 79 | 115 | 0.9 | 6 | ● | 2 | |
| MPS1-0500-L15C | 15 | | 131 | 75.9 | 90.9 | 94 | 130 | 0.9 | 6 | ● | 2 | |
| MPS1-0500-L20C | 20 | | 156 | 100.9 | 115.9 | 119 | 155 | 0.9 | 6 | ● | 2 | |
| MPS1-0500-L25C | 25 | | 181 | 125.9 | 140.9 | 144 | 180 | 0.9 | 6 | ● | 2 | |
| MPS1-0500-L30C | 30 | | 206 | 150.9 | 165.9 | 169 | 205 | 0.9 | 6 | ● | 2 | |
| MPS1-0500-L35C | 35 | | 230 | 175.9 | 190.9 | 193 | 229 | 0.9 | 6 | □ | 2 | |
| MPS1-0500-L40C | 40 | | 255 | 200.9 | 215.9 | 218 | 254 | 0.9 | 6 | ● | 2 | |
| MPS1-0505S-DIN | 5.05 | | 3 | 66 | 20.3 | 28 | 30 | 65.1 | 0.9 | 6 | □ | 4 |
| MPS1-0505S-DIN-C | | 3 | 66 | 20.3 | 28 | 30 | 65.1 | 0.9 | 6 | ● | 2 | |
| MPS1-0505L-DIN | | 5 | 82 | 36.3 | 44 | 46 | 81.1 | 0.9 | 6 | □ | 4 | |
| MPS1-0505L-DIN-C | | 5 | 82 | 36.3 | 44 | 46 | 81.1 | 0.9 | 6 | ● | 2 | |
| MPS1-0510S-DIN | | 5.1 | 3 | 66 | 20.3 | 28 | 30 | 65.1 | 0.9 | 6 | □ | 4 |
| MPS1-0510S-DIN-C | | | 3 | 66 | 20.3 | 28 | 30 | 65.1 | 0.9 | 6 | ● | 2 |
| MPS1-0510L-DIN | | | 5 | 82 | 36.3 | 44 | 46 | 81.1 | 0.9 | 6 | □ | 4 |
| MPS1-0510L-DIN-C | | | 5 | 82 | 36.3 | 44 | 46 | 81.1 | 0.9 | 6 | ● | 2 |
| MPS1-0510-PC | | | 2 | 67 | 11 | 26.8 | 29 | 66 | 0.8 | 6 | ● | 2 |
| MPS1-0510-L8C | | | 8 | 102 | 41.9 | 62 | 65 | 101 | 0.9 | 6 | ● | 2 |
| MPS1-0510-L10C | | | 10 | 113 | 51.9 | 72.9 | 76 | 112 | 0.9 | 6 | □ | 2 |
| MPS1-0510-L12C | | | 12 | 124 | 62.1 | 83.9 | 87 | 123 | 0.9 | 6 | ● | 2 |
| MPS1-0510-L15C | | | 15 | 140 | 77.4 | 99.9 | 103 | 139 | 0.9 | 6 | ● | 2 |
| MPS1-0510-L20C | | | 20 | 168 | 102.9 | 127.9 | 131 | 167 | 0.9 | 6 | ● | 2 |
| MPS1-0510-L25C | | | 25 | 195 | 128.4 | 154.9 | 158 | 194 | 0.9 | 6 | ● | 2 |
| MPS1-0510-L30C | 30 | | 223 | 153.9 | 182.9 | 186 | 222 | 0.9 | 6 | ● | 2 | |
| MPS1-0510-L35C | 35 | | 249 | 179.4 | 203.9 | 212 | 248 | 0.9 | 6 | □ | 2 | |
| MPS1-0510-L40C | 40 | | 279 | 204.9 | 230.9 | 242 | 278 | 0.9 | 6 | ● | 2 | |

MPS1

VOLLHARTMETALLBOHRER

| Bestellnummer | DC | (l/d) | OAL | LU | LCF | LH | LF | PL | DCON | DP1021 | Typ |
|------------------|-----|-------|-----|-------|-------|-----|------|-----|------|--------|-----|
| MPS1-0520S-DIN | 5.2 | 3 | 66 | 20.1 | 28 | 30 | 65.1 | 0.9 | 6 | □ | 4 |
| MPS1-0520S-DIN-C | | 3 | 66 | 20.1 | 28 | 30 | 65.1 | 0.9 | 6 | ● | 2 |
| MPS1-0520L-DIN | | 5 | 82 | 36.1 | 44 | 46 | 81.1 | 0.9 | 6 | □ | 4 |
| MPS1-0520L-DIN-C | | 5 | 82 | 36.1 | 44 | 46 | 81.1 | 0.9 | 6 | ● | 2 |
| MPS1-0520-PC | | 2 | 67 | 11.2 | 26.8 | 29 | 66 | 0.8 | 6 | ● | 2 |
| MPS1-0520-L8C | | 8 | 102 | 42.7 | 62 | 65 | 101 | 0.9 | 6 | ● | 2 |
| MPS1-0520-L10C | | 10 | 113 | 52.9 | 72.9 | 76 | 112 | 0.9 | 6 | □ | 2 |
| MPS1-0520-L12C | | 12 | 124 | 63.3 | 83.9 | 87 | 123 | 0.9 | 6 | ● | 2 |
| MPS1-0520-L15C | | 15 | 140 | 78.9 | 99.9 | 103 | 139 | 0.9 | 6 | ● | 2 |
| MPS1-0520-L20C | | 20 | 168 | 104.9 | 127.9 | 131 | 167 | 0.9 | 6 | ● | 2 |
| MPS1-0520-L25C | | 25 | 195 | 130.9 | 154.9 | 158 | 194 | 0.9 | 6 | ● | 2 |
| MPS1-0520-L30C | | 30 | 223 | 156.9 | 182.9 | 186 | 222 | 0.9 | 6 | ● | 2 |
| MPS1-0520-L35C | | 35 | 249 | 182.9 | 203.9 | 212 | 248 | 0.9 | 6 | □ | 2 |
| MPS1-0520-L40C | | 40 | 279 | 208.9 | 230.9 | 242 | 278 | 0.9 | 6 | ● | 2 |
| MPS1-0530S-DIN | | 5.3 | 3 | 66 | 20.0 | 28 | 30 | 65 | 1.0 | 6 | □ |
| MPS1-0530S-DIN-C | 3 | | 66 | 20.0 | 28 | 30 | 65 | 1.0 | 6 | ● | 2 |
| MPS1-0530L-DIN | 5 | | 82 | 36.0 | 44 | 46 | 81 | 1.0 | 6 | □ | 4 |
| MPS1-0530L-DIN-C | 5 | | 82 | 36.0 | 44 | 46 | 81 | 1.0 | 6 | ● | 2 |
| MPS1-0530-PC | 2 | | 67 | 11.4 | 26.8 | 29 | 66 | 0.8 | 6 | ● | 2 |
| MPS1-0530-L8C | 8 | | 102 | 43.5 | 62 | 65 | 101 | 1.0 | 6 | ● | 2 |
| MPS1-0530-L10C | 10 | | 113 | 54 | 73 | 76 | 112 | 1.0 | 6 | □ | 2 |
| MPS1-0530-L12C | 12 | | 124 | 64.6 | 84 | 87 | 123 | 1.0 | 6 | ● | 2 |
| MPS1-0530-L15C | 15 | | 140 | 80.5 | 100 | 103 | 139 | 1.0 | 6 | ● | 2 |
| MPS1-0530-L20C | 20 | | 168 | 107 | 128 | 131 | 167 | 1.0 | 6 | □ | 2 |
| MPS1-0530-L25C | 25 | | 195 | 133.5 | 155 | 158 | 194 | 1.0 | 6 | ● | 2 |
| MPS1-0530-L30C | 30 | | 223 | 160 | 183 | 186 | 222 | 1.0 | 6 | ● | 2 |
| MPS1-0530-L35C | 35 | | 249 | 186.5 | 210 | 212 | 248 | 1.0 | 6 | □ | 2 |
| MPS1-0530-L40C | 40 | | 279 | 213 | 241 | 242 | 278 | 1.0 | 6 | ● | 2 |
| MPS1-0540S-DIN-C | 5.4 | | 3 | 66 | 19.9 | 28 | 30 | 65 | 1.0 | 6 | ● |
| MPS1-0540S-DIN | | 3 | 66 | 19.9 | 28 | 30 | 65 | 1.0 | 6 | □ | 4 |
| MPS1-0540L-DIN | | 5 | 82 | 35.9 | 44 | 46 | 81 | 1.0 | 6 | □ | 4 |
| MPS1-0540L-DIN-C | | 5 | 82 | 35.9 | 44 | 46 | 81 | 1.0 | 6 | ● | 2 |
| MPS1-0540-PC | | 2 | 67 | 11.7 | 26.9 | 29 | 66 | 0.9 | 6 | ● | 2 |
| MPS1-0540-L8C | | 8 | 102 | 44.3 | 62 | 65 | 101 | 1.0 | 6 | ● | 2 |
| MPS1-0540-L10C | | 10 | 113 | 55 | 73 | 76 | 112 | 1.0 | 6 | □ | 2 |
| MPS1-0540-L12C | | 12 | 124 | 65.8 | 84 | 87 | 123 | 1.0 | 6 | ● | 2 |
| MPS1-0540-L15C | | 15 | 140 | 82 | 100 | 103 | 139 | 1.0 | 6 | ● | 2 |
| MPS1-0540-L20C | | 20 | 168 | 109 | 128 | 131 | 167 | 1.0 | 6 | ● | 2 |
| MPS1-0540-L25C | | 25 | 195 | 136 | 155 | 158 | 194 | 1.0 | 6 | □ | 2 |
| MPS1-0540-L30C | | 30 | 223 | 163 | 183 | 186 | 222 | 1.0 | 6 | □ | 2 |
| MPS1-0540-L35C | | 35 | 249 | 190 | 210 | 212 | 248 | 1.0 | 6 | □ | 2 |
| MPS1-0540-L40C | | 40 | 279 | 217 | 241 | 242 | 278 | 1.0 | 6 | ● | 2 |

MPS1

VOLLHARTMETALLBOHRER

| Bestellnummer | DC | (l/d) | OAL | LU | LCF | LH | LF | PL | DCON | DP1021 | Typ |
|------------------|-----|-------|-----|-------|------|-----|-----|-----|------|--------|-----|
| MPS1-0550S-DIN | 5.5 | 3 | 66 | 19.8 | 28 | 30 | 65 | 1.0 | 6 | □ | 4 |
| MPS1-0550S-DIN-C | | 3 | 66 | 19.8 | 28 | 30 | 65 | 1.0 | 6 | ● | 2 |
| MPS1-0550L-DIN | | 5 | 82 | 35.8 | 44 | 46 | 81 | 1.0 | 6 | □ | 4 |
| MPS1-0550L-DIN-C | | 5 | 82 | 35.8 | 44 | 46 | 81 | 1.0 | 6 | ● | 2 |
| MPS1-0550-PC | | 2 | 67 | 11.9 | 26.9 | 29 | 66 | 0.9 | 6 | ● | 2 |
| MPS1-0550-L8C | | 8 | 102 | 45.1 | 62 | 65 | 101 | 1.0 | 6 | ● | 2 |
| MPS1-0550-L10C | | 10 | 113 | 56 | 73 | 76 | 112 | 1.0 | 6 | □ | 2 |
| MPS1-0550-L12C | | 12 | 124 | 67 | 84 | 87 | 123 | 1.0 | 6 | ● | 2 |
| MPS1-0550-L15C | | 15 | 140 | 83.5 | 100 | 103 | 139 | 1.0 | 6 | ● | 2 |
| MPS1-0550-L20C | | 20 | 168 | 111 | 128 | 131 | 167 | 1.0 | 6 | ● | 2 |
| MPS1-0550-L25C | | 25 | 195 | 138.5 | 155 | 158 | 194 | 1.0 | 6 | ● | 2 |
| MPS1-0550-L30C | | 30 | 223 | 166 | 183 | 186 | 222 | 1.0 | 6 | ● | 2 |
| MPS1-0550-L35C | | 35 | 249 | 193.5 | 210 | 212 | 248 | 1.0 | 6 | □ | 2 |
| MPS1-0550-L40C | | 40 | 279 | 221 | 241 | 242 | 278 | 1.0 | 6 | ● | 2 |
| MPS1-0555S-DIN | | 5.55 | 3 | 66 | 19.7 | 28 | 30 | 65 | 1.0 | 6 | □ |
| MPS1-0555S-DIN-C | 3 | | 66 | 19.7 | 28 | 30 | 65 | 1.0 | 6 | ● | 2 |
| MPS1-0555L-DIN | 5 | | 82 | 35.7 | 44 | 46 | 81 | 1.0 | 6 | □ | 4 |
| MPS1-0555L-DIN-C | 5 | | 82 | 35.7 | 44 | 46 | 81 | 1.0 | 6 | ● | 2 |
| MPS1-0560S-DIN | 5.6 | | 3 | 66 | 19.6 | 28 | 30 | 65 | 1.0 | 6 | □ |
| MPS1-0560S-DIN-C | | 3 | 66 | 19.6 | 28 | 30 | 65 | 1.0 | 6 | ● | 2 |
| MPS1-0560L-DIN | | 5 | 82 | 35.6 | 44 | 46 | 81 | 1.0 | 6 | □ | 4 |
| MPS1-0560L-DIN-C | | 5 | 82 | 35.6 | 44 | 46 | 81 | 1.0 | 6 | ● | 2 |
| MPS1-0560-PC | | 2 | 67 | 12.1 | 28.9 | 29 | 66 | 0.9 | 6 | ● | 2 |
| MPS1-0560-L8C | | 8 | 107 | 46.0 | 67 | 70 | 106 | 1.0 | 6 | ● | 2 |
| MPS1-0560-L10C | | 10 | 119 | 57 | 79 | 82 | 118 | 1.0 | 6 | □ | 2 |
| MPS1-0560-L12C | | 12 | 131 | 68.2 | 91 | 94 | 130 | 1.0 | 6 | ● | 2 |
| MPS1-0560-L15C | | 15 | 149 | 85 | 109 | 112 | 148 | 1.0 | 6 | ● | 2 |
| MPS1-0560-L20C | | 20 | 179 | 113 | 139 | 142 | 178 | 1.0 | 6 | □ | 2 |
| MPS1-0560-L25C | | 25 | 209 | 141 | 169 | 172 | 208 | 1.0 | 6 | □ | 2 |
| MPS1-0560-L30C | | 30 | 239 | 169 | 199 | 202 | 238 | 1.0 | 6 | ● | 2 |
| MPS1-0560-L35C | | 35 | 268 | 197 | 223 | 231 | 267 | 1.0 | 6 | □ | 2 |
| MPS1-0560-L40C | | 40 | 299 | 225 | 251 | 262 | 298 | 1.0 | 6 | ● | 2 |
| MPS1-0570S-DIN | | 5.7 | 3 | 66 | 19.5 | 28 | 30 | 65 | 1.0 | 6 | □ |
| MPS1-0570S-DIN-C | 3 | | 66 | 19.5 | 28 | 30 | 65 | 1.0 | 6 | ● | 2 |
| MPS1-0570L-DIN | 5 | | 82 | 35.5 | 44 | 46 | 81 | 1.0 | 6 | □ | 4 |
| MPS1-0570L-DIN-C | 5 | | 82 | 35.5 | 44 | 46 | 81 | 1.0 | 6 | ● | 2 |
| MPS1-0570-PC | 2 | | 67 | 12.3 | 28.9 | 29 | 66 | 0.9 | 6 | ● | 2 |
| MPS1-0570-L8C | 8 | | 107 | 46.8 | 67 | 70 | 106 | 1.0 | 6 | ● | 2 |
| MPS1-0570-L10C | 10 | | 119 | 58 | 79 | 82 | 118 | 1.0 | 6 | □ | 2 |
| MPS1-0570-L12C | 12 | | 131 | 69.4 | 91 | 94 | 130 | 1.0 | 6 | ● | 2 |
| MPS1-0570-L15C | 15 | | 149 | 86.5 | 109 | 112 | 148 | 1.0 | 6 | ● | 2 |
| MPS1-0570-L20C | 20 | | 179 | 115 | 139 | 142 | 178 | 1.0 | 6 | □ | 2 |
| MPS1-0570-L25C | 25 | | 209 | 143.5 | 169 | 172 | 208 | 1.0 | 6 | ● | 2 |
| MPS1-0570-L30C | 30 | | 239 | 172 | 199 | 202 | 238 | 1.0 | 6 | □ | 2 |
| MPS1-0570-L35C | 35 | | 268 | 200.5 | 223 | 231 | 267 | 1.0 | 6 | □ | 2 |
| MPS1-0570-L40C | 40 | | 299 | 229 | 251 | 262 | 298 | 1.0 | 6 | ● | 2 |

MPS1

VOLLHARTMETALLBOHRER

| Bestellnummer | DC | (l/d) | OAL | LU | LCF | LH | LF | PL | DCON | DP1021 | Typ |
|------------------|------|-------|-----|-------|-------|-----|------|-----|------|--------|-----|
| MPS1-0580S-DIN | 5.8 | 3 | 66 | 19.4 | 28 | 30 | 64.9 | 1.1 | 6 | □ | 4 |
| MPS1-0580S-DIN-C | | 3 | 66 | 19.4 | 28 | 30 | 64.9 | 1.1 | 6 | ● | 2 |
| MPS1-0580L-DIN | | 5 | 82 | 35.4 | 44 | 46 | 80.9 | 1.1 | 6 | □ | 4 |
| MPS1-0580L-DIN-C | | 5 | 82 | 35.4 | 44 | 46 | 80.9 | 1.1 | 6 | ● | 2 |
| MPS1-0580-PC | | 2 | 67 | 12.5 | 28.9 | 29 | 66 | 0.9 | 6 | ● | 2 |
| MPS1-0580-L8C | | 8 | 107 | 47.6 | 67 | 70 | 106 | 1.1 | 6 | ● | 2 |
| MPS1-0580-L10C | | 10 | 119 | 59.1 | 79.1 | 82 | 118 | 1.1 | 6 | □ | 2 |
| MPS1-0580-L12C | | 12 | 131 | 70.7 | 91.1 | 94 | 130 | 1.1 | 6 | ● | 2 |
| MPS1-0580-L15C | | 15 | 149 | 88.1 | 109.1 | 112 | 148 | 1.1 | 6 | ● | 2 |
| MPS1-0580-L20C | | 20 | 179 | 117.1 | 139.1 | 142 | 178 | 1.1 | 6 | ● | 2 |
| MPS1-0580-L25C | | 25 | 209 | 146.1 | 169.1 | 172 | 208 | 1.1 | 6 | □ | 2 |
| MPS1-0580-L30C | | 30 | 239 | 175.1 | 199.1 | 202 | 238 | 1.1 | 6 | ● | 2 |
| MPS1-0580-L35C | | 35 | 268 | 204.1 | 229.1 | 231 | 267 | 1.1 | 6 | □ | 2 |
| MPS1-0580-L40C | | 40 | 299 | 233.1 | 261.1 | 262 | 298 | 1.1 | 6 | ● | 2 |
| MPS1-0590S-DIN | 5.9 | 3 | 66 | 19.2 | 28 | 30 | 64.9 | 1.1 | 6 | □ | 4 |
| MPS1-0590S-DIN-C | | 3 | 66 | 19.2 | 28 | 30 | 64.9 | 1.1 | 6 | ● | 2 |
| MPS1-0590L-DIN | | 5 | 82 | 35.2 | 44 | 46 | 80.9 | 1.1 | 6 | □ | 4 |
| MPS1-0590L-DIN-C | | 5 | 82 | 35.2 | 44 | 46 | 80.9 | 1.1 | 6 | ● | 2 |
| MPS1-0590-PC | | 2 | 67 | 12.7 | 28.9 | 29 | 66 | 0.9 | 6 | ● | 2 |
| MPS1-0590-L8C | | 8 | 107 | 48.4 | 67 | 70 | 106 | 1.1 | 6 | ● | 2 |
| MPS1-0590-L10C | | 10 | 119 | 60.1 | 79.1 | 82 | 118 | 1.1 | 6 | □ | 2 |
| MPS1-0590-L12C | | 12 | 131 | 71.9 | 91.1 | 94 | 130 | 1.1 | 6 | ● | 2 |
| MPS1-0590-L15C | | 15 | 149 | 89.6 | 109.1 | 112 | 148 | 1.1 | 6 | ● | 2 |
| MPS1-0590-L20C | | 20 | 179 | 119.1 | 139.1 | 142 | 178 | 1.1 | 6 | ● | 2 |
| MPS1-0590-L25C | | 25 | 209 | 148.6 | 169.1 | 172 | 208 | 1.1 | 6 | ● | 2 |
| MPS1-0590-L30C | | 30 | 239 | 178.1 | 199.1 | 202 | 238 | 1.1 | 6 | □ | 2 |
| MPS1-0590-L35C | | 35 | 268 | 207.6 | 229.1 | 231 | 267 | 1.1 | 6 | □ | 2 |
| MPS1-0590-L40C | | 40 | 299 | 237.1 | 261.1 | 262 | 298 | 1.1 | 6 | ● | 2 |
| MPS1-0600S-DIN | 6 | 3 | 66 | 19.1 | 28 | 30 | 64.9 | 1.1 | 6 | □ | 4 |
| MPS1-0600S-DIN-C | | 3 | 66 | 19.1 | 28 | 30 | 64.9 | 1.1 | 6 | ● | 2 |
| MPS1-0600L-DIN | | 5 | 82 | 35.1 | 44 | 46 | 80.9 | 1.1 | 6 | □ | 4 |
| MPS1-0600L-DIN-C | | 5 | 82 | 35.1 | 44 | 46 | 80.9 | 1.1 | 6 | ● | 2 |
| MPS1-0600-PC | | 2 | 67 | 12.9 | 28.9 | 29 | 66 | 0.9 | 6 | ● | 2 |
| MPS1-0600-L8C | | 8 | 107 | 49.2 | 67 | 70 | 106 | 1.1 | 6 | ● | 2 |
| MPS1-0600-L10C | | 10 | 119 | 61.1 | 79.1 | 82 | 118 | 1.1 | 6 | ● | 2 |
| MPS1-0600-L12C | | 12 | 131 | 73.1 | 91.1 | 94 | 130 | 1.1 | 6 | ● | 2 |
| MPS1-0600-L15C | | 15 | 149 | 91.1 | 109.1 | 112 | 148 | 1.1 | 6 | ● | 2 |
| MPS1-0600-L20C | | 20 | 179 | 121.1 | 139.1 | 142 | 178 | 1.1 | 6 | ● | 2 |
| MPS1-0600-L25C | | 25 | 209 | 151.1 | 169.1 | 172 | 208 | 1.1 | 6 | ● | 2 |
| MPS1-0600-L30C | | 30 | 239 | 181.1 | 199.1 | 202 | 238 | 1.1 | 6 | ● | 2 |
| MPS1-0600-L35C | | 35 | 268 | 211.1 | 229.1 | 231 | 267 | 1.1 | 6 | □ | 2 |
| MPS1-0600-L40C | | 40 | 299 | 241.1 | 261.1 | 262 | 298 | 1.1 | 6 | ● | 2 |
| MPS1-0605S-DIN | 6.05 | 3 | 79 | 25.0 | 34 | 43 | 77.9 | 1.1 | 8 | □ | 4 |
| MPS1-0605S-DIN-C | | 3 | 79 | 25.0 | 34 | 43 | 77.9 | 1.1 | 8 | ● | 2 |
| MPS1-0605L-DIN | | 5 | 91 | 44.0 | 53 | 55 | 89.9 | 1.1 | 8 | □ | 4 |
| MPS1-0605L-DIN-C | | 5 | 91 | 44.0 | 53 | 55 | 89.9 | 1.1 | 8 | ● | 2 |

MPS1

VOLLHARTMETALLBOHRER

| Bestellnummer | DC | (l/d) | OAL | LU | LCF | LH | LF | PL | DCON | DP1021 | Typ |
|------------------|-----|-------|-----|-------|-------|-----|------|------|------|--------|-----|
| MPS1-0610S-DIN | 6.1 | 3 | 79 | 25.0 | 34 | 43 | 77.9 | 1.1 | 8 | □ | 4 |
| MPS1-0610S-DIN-C | | 3 | 79 | 25.0 | 34 | 43 | 77.9 | 1.1 | 8 | ● | 2 |
| MPS1-0610L-DIN | | 5 | 91 | 44.0 | 53 | 55 | 89.9 | 1.1 | 8 | □ | 4 |
| MPS1-0610L-DIN-C | | 5 | 91 | 44.0 | 53 | 55 | 89.9 | 1.1 | 8 | ● | 2 |
| MPS1-0610-PC | | 2 | 75 | 13.2 | 32 | 35 | 74 | 1.0 | 8 | ● | 2 |
| MPS1-0610-L8C | | 8 | 113 | 50.1 | 73 | 76 | 112 | 1.1 | 8 | ● | 2 |
| MPS1-0610-L10C | | 10 | 126 | 62.1 | 86.1 | 89 | 125 | 1.1 | 8 | □ | 2 |
| MPS1-0610-L12C | | 12 | 139 | 74.3 | 99.1 | 102 | 138 | 1.1 | 8 | ● | 2 |
| MPS1-0610-L15C | | 15 | 158 | 92.6 | 118.1 | 121 | 157 | 1.1 | 8 | ● | 2 |
| MPS1-0610-L20C | | 20 | 191 | 123.1 | 151.1 | 154 | 190 | 1.1 | 8 | ● | 2 |
| MPS1-0610-L25C | | 25 | 223 | 153.6 | 183.1 | 186 | 222 | 1.1 | 8 | ● | 2 |
| MPS1-0610-L30C | | 30 | 256 | 184.1 | 216.1 | 219 | 255 | 1.1 | 8 | ● | 2 |
| MPS1-0610-L35C | | 35 | 287 | 214.6 | 241.1 | 250 | 286 | 1.1 | 8 | □ | 2 |
| MPS1-0610-L40C | | 40 | 321 | 245.1 | 271.1 | 284 | 320 | 1.1 | 8 | ● | 2 |
| MPS1-0620S-DIN | | 6.2 | 3 | 79 | 24.8 | 34 | 43 | 77.9 | 1.1 | 8 | □ |
| MPS1-0620S-DIN-C | 3 | | 79 | 24.8 | 34 | 43 | 77.9 | 1.1 | 8 | ● | 2 |
| MPS1-0620L-DIN | 5 | | 91 | 43.8 | 53 | 55 | 89.9 | 1.1 | 8 | □ | 4 |
| MPS1-0620L-DIN-C | 5 | | 91 | 43.8 | 53 | 55 | 89.9 | 1.1 | 8 | ● | 2 |
| MPS1-0620-PC | 2 | | 75 | 13.4 | 32 | 35 | 74 | 1.0 | 8 | ● | 2 |
| MPS1-0620-L8C | 8 | | 113 | 50.9 | 73 | 76 | 112 | 1.1 | 8 | ● | 2 |
| MPS1-0620-L10C | 10 | | 126 | 63.1 | 86.1 | 89 | 125 | 1.1 | 8 | □ | 2 |
| MPS1-0620-L12C | 12 | | 139 | 75.5 | 99.1 | 102 | 138 | 1.1 | 8 | ● | 2 |
| MPS1-0620-L15C | 15 | | 158 | 94.1 | 118.1 | 121 | 157 | 1.1 | 8 | ● | 2 |
| MPS1-0620-L20C | 20 | | 191 | 125.1 | 151.1 | 154 | 190 | 1.1 | 8 | ● | 2 |
| MPS1-0620-L25C | 25 | | 223 | 156.1 | 183.1 | 186 | 222 | 1.1 | 8 | □ | 2 |
| MPS1-0620-L30C | 30 | | 256 | 187.1 | 216.1 | 219 | 255 | 1.1 | 8 | ● | 2 |
| MPS1-0620-L35C | 35 | | 287 | 218.1 | 241.1 | 250 | 286 | 1.1 | 8 | □ | 2 |
| MPS1-0620-L40C | 40 | | 321 | 249.1 | 271.1 | 284 | 320 | 1.1 | 8 | ● | 2 |
| MPS1-0630S-DIN | 6.3 | | 3 | 79 | 24.7 | 34 | 43 | 77.9 | 1.1 | 8 | □ |
| MPS1-0630S-DIN-C | | 3 | 79 | 24.7 | 34 | 43 | 77.9 | 1.1 | 8 | ● | 2 |
| MPS1-0630L-DIN | | 5 | 91 | 43.7 | 53 | 55 | 89.9 | 1.1 | 8 | □ | 4 |
| MPS1-0630L-DIN-C | | 5 | 91 | 43.7 | 53 | 55 | 89.9 | 1.1 | 8 | ● | 2 |
| MPS1-0630-PC | | 2 | 75 | 13.6 | 32 | 35 | 74 | 1.0 | 8 | ● | 2 |
| MPS1-0630-L8C | | 8 | 113 | 51.7 | 73 | 76 | 112 | 1.1 | 8 | ● | 2 |
| MPS1-0630-L10C | | 10 | 126 | 64.1 | 86.1 | 89 | 125 | 1.1 | 8 | □ | 2 |
| MPS1-0630-L12C | | 12 | 139 | 76.7 | 99.1 | 102 | 138 | 1.1 | 8 | ● | 2 |
| MPS1-0630-L15C | | 15 | 158 | 95.6 | 118.1 | 121 | 157 | 1.1 | 8 | ● | 2 |
| MPS1-0630-L20C | | 20 | 191 | 127.1 | 151.1 | 154 | 190 | 1.1 | 8 | ● | 2 |
| MPS1-0630-L25C | | 25 | 223 | 158.6 | 183.1 | 186 | 222 | 1.1 | 8 | □ | 2 |
| MPS1-0630-L30C | | 30 | 256 | 190.1 | 216.1 | 219 | 255 | 1.1 | 8 | ● | 2 |
| MPS1-0630-L35C | | 35 | 287 | 221.6 | 248.1 | 250 | 286 | 1.1 | 8 | □ | 2 |
| MPS1-0630-L40C | | 40 | 321 | 253.1 | 281.1 | 284 | 320 | 1.1 | 8 | ● | 2 |

MPS1

VOLLHARTMETALLBOHRER

| Bestellnummer | DC | (l/d) | OAL | LU | LCF | LH | LF | PL | DCON | DP1021 | Typ |
|------------------|-----|-------|-----|-------|-------|-----|------|-----|------|--------|-----|
| MPS1-0640S-DIN | 6.4 | 3 | 79 | 24.6 | 34 | 43 | 77.8 | 1.2 | 8 | □ | 4 |
| MPS1-0640S-DIN-C | | 3 | 79 | 24.6 | 34 | 43 | 77.8 | 1.2 | 8 | ● | 2 |
| MPS1-0640L-DIN | | 5 | 91 | 43.6 | 53 | 55 | 89.8 | 1.2 | 8 | □ | 4 |
| MPS1-0640L-DIN-C | | 5 | 91 | 43.6 | 53 | 55 | 89.8 | 1.2 | 8 | ● | 2 |
| MPS1-0640-PC | | 2 | 75 | 13.8 | 32 | 35 | 74 | 1.0 | 8 | ● | 2 |
| MPS1-0640-L8C | | 8 | 113 | 52.5 | 73 | 76 | 112 | 1.2 | 8 | ● | 2 |
| MPS1-0640-L10C | | 10 | 126 | 65.2 | 86.2 | 89 | 125 | 1.2 | 8 | □ | 2 |
| MPS1-0640-L12C | | 12 | 139 | 78 | 99.2 | 102 | 138 | 1.2 | 8 | ● | 2 |
| MPS1-0640-L15C | | 15 | 158 | 97.2 | 118.2 | 121 | 157 | 1.2 | 8 | ● | 2 |
| MPS1-0640-L20C | | 20 | 191 | 129.2 | 151.2 | 154 | 190 | 1.2 | 8 | ● | 2 |
| MPS1-0640-L25C | | 25 | 223 | 161.2 | 183.2 | 186 | 222 | 1.2 | 8 | ● | 2 |
| MPS1-0640-L30C | | 30 | 256 | 193.2 | 216.2 | 219 | 255 | 1.2 | 8 | ● | 2 |
| MPS1-0640-L35C | | 35 | 287 | 225.2 | 248.2 | 250 | 286 | 1.2 | 8 | □ | 2 |
| MPS1-0640-L40C | | 40 | 321 | 257.2 | 281.2 | 284 | 320 | 1.2 | 8 | ● | 2 |
| MPS1-0650S-DIN | 6.5 | 3 | 79 | 24.4 | 34 | 43 | 77.8 | 1.2 | 8 | □ | 4 |
| MPS1-0650S-DIN-C | | 3 | 79 | 24.4 | 34 | 43 | 77.8 | 1.2 | 8 | ● | 2 |
| MPS1-0650L-DIN | | 5 | 91 | 43.4 | 53 | 55 | 89.8 | 1.2 | 8 | □ | 4 |
| MPS1-0650L-DIN-C | | 5 | 91 | 43.4 | 53 | 55 | 89.8 | 1.2 | 8 | ● | 2 |
| MPS1-0650-PC | | 2 | 75 | 14 | 32 | 35 | 74 | 1.0 | 8 | ● | 2 |
| MPS1-0650-L8C | | 8 | 113 | 53.3 | 73 | 76 | 112 | 1.2 | 8 | ● | 2 |
| MPS1-0650-L10C | | 10 | 126 | 66.2 | 86.2 | 89 | 125 | 1.2 | 8 | □ | 2 |
| MPS1-0650-L12C | | 12 | 139 | 79.2 | 99.2 | 102 | 138 | 1.2 | 8 | ● | 2 |
| MPS1-0650-L15C | | 15 | 158 | 98.7 | 118.2 | 121 | 157 | 1.2 | 8 | ● | 2 |
| MPS1-0650-L20C | | 20 | 191 | 131.2 | 151.2 | 154 | 190 | 1.2 | 8 | ● | 2 |
| MPS1-0650-L25C | | 25 | 223 | 163.7 | 183.2 | 186 | 222 | 1.2 | 8 | ● | 2 |
| MPS1-0650-L30C | | 30 | 256 | 196.2 | 216.2 | 219 | 255 | 1.2 | 8 | ● | 2 |
| MPS1-0650-L35C | | 35 | 287 | 228.7 | 248.2 | 250 | 286 | 1.2 | 8 | □ | 2 |
| MPS1-0650-L40C | | 40 | 321 | 261.2 | 281.2 | 284 | 320 | 1.2 | 8 | ● | 2 |
| MPS1-0660S-DIN | 6.6 | 3 | 79 | 24.3 | 34 | 43 | 77.8 | 1.2 | 8 | □ | 4 |
| MPS1-0660S-DIN-C | | 3 | 79 | 24.3 | 34 | 43 | 77.8 | 1.2 | 8 | ● | 2 |
| MPS1-0660L-DIN | | 5 | 91 | 43.3 | 53 | 55 | 89.8 | 1.2 | 8 | □ | 4 |
| MPS1-0660L-DIN-C | | 5 | 91 | 43.3 | 53 | 55 | 89.8 | 1.2 | 8 | ● | 2 |
| MPS1-0660-PC | | 2 | 75 | 14.2 | 35 | 37 | 74 | 1.0 | 8 | ● | 2 |
| MPS1-0660-L8C | | 8 | 118 | 54.2 | 78 | 81 | 117 | 1.2 | 8 | ● | 2 |
| MPS1-0660-L10C | | 10 | 132 | 67.2 | 92.2 | 95 | 131 | 1.2 | 8 | □ | 2 |
| MPS1-0660-L12C | | 12 | 146 | 80.4 | 106.2 | 109 | 145 | 1.2 | 8 | ● | 2 |
| MPS1-0660-L15C | | 15 | 167 | 100.2 | 127.2 | 130 | 166 | 1.2 | 8 | ● | 2 |
| MPS1-0660-L20C | | 20 | 202 | 133.2 | 162.2 | 165 | 201 | 1.2 | 8 | □ | 2 |
| MPS1-0660-L25C | | 25 | 237 | 166.2 | 197.2 | 200 | 236 | 1.2 | 8 | ● | 2 |
| MPS1-0660-L30C | | 30 | 272 | 199.2 | 232.2 | 235 | 271 | 1.2 | 8 | ● | 2 |
| MPS1-0660-L35C | | 35 | 306 | 232.2 | 267.2 | 269 | 305 | 1.2 | 8 | □ | 2 |
| MPS1-0660-L40C | | 40 | 341 | 265.2 | 301.2 | 304 | 340 | 1.2 | 8 | ● | 2 |

MPS1

VOLLHARTMETALLBOHRER

| Bestellnummer | DC | (l/d) | OAL | LU | LCF | LH | LF | PL | DCON | DP1021 | Typ |
|------------------|-----|-------|-----|-------|-------|-----|------|-----|------|--------|-----|
| MPS1-0670S-DIN | 6.7 | 3 | 79 | 24.2 | 34 | 43 | 77.8 | 1.2 | 8 | □ | 4 |
| MPS1-0670S-DIN-C | | 3 | 79 | 24.2 | 34 | 43 | 77.8 | 1.2 | 8 | ● | 2 |
| MPS1-0670L-DIN | | 5 | 91 | 43.2 | 53 | 55 | 89.8 | 1.2 | 8 | □ | 4 |
| MPS1-0670L-DIN-C | | 5 | 91 | 43.2 | 53 | 55 | 89.8 | 1.2 | 8 | ● | 2 |
| MPS1-0670-PC | | 2 | 75 | 14.5 | 35.1 | 37 | 74 | 1.1 | 8 | ● | 2 |
| MPS1-0670-L8C | | 8 | 118 | 55.0 | 78 | 81 | 117 | 1.2 | 8 | ● | 2 |
| MPS1-0670-L10C | | 10 | 132 | 68.2 | 92.2 | 95 | 131 | 1.2 | 8 | □ | 2 |
| MPS1-0670-L12C | | 12 | 146 | 81.6 | 106.2 | 109 | 145 | 1.2 | 8 | ● | 2 |
| MPS1-0670-L15C | | 15 | 167 | 101.7 | 127.2 | 130 | 166 | 1.2 | 8 | ● | 2 |
| MPS1-0670-L20C | | 20 | 202 | 135.2 | 162.2 | 165 | 201 | 1.2 | 8 | □ | 2 |
| MPS1-0670-L25C | | 25 | 237 | 168.7 | 197.2 | 200 | 236 | 1.2 | 8 | □ | 2 |
| MPS1-0670-L30C | | 30 | 272 | 202.2 | 232.2 | 235 | 271 | 1.2 | 8 | ● | 2 |
| MPS1-0670-L35C | | 35 | 306 | 235.7 | 267.2 | 269 | 305 | 1.2 | 8 | □ | 2 |
| MPS1-0670-L40C | | 40 | 341 | 269.2 | 301.2 | 304 | 340 | 1.2 | 8 | ● | 2 |
| MPS1-0680S-DIN | 6.8 | 3 | 79 | 24.0 | 34 | 43 | 77.8 | 1.2 | 8 | □ | 4 |
| MPS1-0680S-DIN-C | | 3 | 79 | 24.0 | 34 | 43 | 77.8 | 1.2 | 8 | ● | 2 |
| MPS1-0680L-DIN | | 5 | 91 | 43.0 | 53 | 55 | 89.8 | 1.2 | 8 | □ | 4 |
| MPS1-0680L-DIN-C | | 5 | 91 | 43.0 | 53 | 55 | 89.8 | 1.2 | 8 | ● | 2 |
| MPS1-0680-PC | | 2 | 75 | 14.7 | 35.1 | 37 | 74 | 1.1 | 8 | ● | 2 |
| MPS1-0680-L8C | | 8 | 118 | 55.8 | 78 | 81 | 117 | 1.2 | 8 | ● | 2 |
| MPS1-0680-L10C | | 10 | 132 | 69.2 | 92.2 | 95 | 131 | 1.2 | 8 | □ | 2 |
| MPS1-0680-L12C | | 12 | 146 | 82.8 | 106.2 | 109 | 145 | 1.2 | 8 | ● | 2 |
| MPS1-0680-L15C | | 15 | 167 | 103.2 | 127.2 | 130 | 166 | 1.2 | 8 | ● | 2 |
| MPS1-0680-L20C | | 20 | 202 | 137.2 | 162.2 | 165 | 201 | 1.2 | 8 | ● | 2 |
| MPS1-0680-L25C | | 25 | 237 | 171.2 | 197.2 | 200 | 236 | 1.2 | 8 | ● | 2 |
| MPS1-0680-L30C | | 30 | 272 | 205.2 | 232.2 | 235 | 271 | 1.2 | 8 | ● | 2 |
| MPS1-0680-L35C | | 35 | 306 | 239.2 | 267.2 | 269 | 305 | 1.2 | 8 | □ | 2 |
| MPS1-0680-L40C | | 40 | 341 | 273.2 | 301.2 | 304 | 340 | 1.2 | 8 | ● | 2 |
| MPS1-0690S-DIN | 6.9 | 3 | 79 | 23.9 | 34 | 43 | 77.7 | 1.3 | 8 | □ | 4 |
| MPS1-0690S-DIN-C | | 3 | 79 | 23.9 | 34 | 43 | 77.7 | 1.3 | 8 | ● | 2 |
| MPS1-0690L-DIN | | 5 | 91 | 42.9 | 53 | 55 | 89.7 | 1.3 | 8 | □ | 4 |
| MPS1-0690L-DIN-C | | 5 | 91 | 42.9 | 53 | 55 | 89.7 | 1.3 | 8 | ● | 2 |
| MPS1-0690-PC | | 2 | 75 | 14.9 | 35.1 | 37 | 74 | 1.1 | 8 | ● | 2 |
| MPS1-0690-L8C | | 8 | 118 | 56.6 | 78 | 81 | 117 | 1.3 | 8 | ● | 2 |
| MPS1-0690-L10C | | 10 | 132 | 70.3 | 92.3 | 95 | 131 | 1.3 | 8 | □ | 2 |
| MPS1-0690-L12C | | 12 | 146 | 84.1 | 106.3 | 109 | 145 | 1.3 | 8 | ● | 2 |
| MPS1-0690-L15C | | 15 | 167 | 104.8 | 127.3 | 130 | 166 | 1.3 | 8 | ● | 2 |
| MPS1-0690-L20C | | 20 | 202 | 139.3 | 162.3 | 165 | 201 | 1.3 | 8 | ● | 2 |
| MPS1-0690-L25C | | 25 | 237 | 173.8 | 197.3 | 200 | 236 | 1.3 | 8 | ● | 2 |
| MPS1-0690-L30C | | 30 | 272 | 208.3 | 232.3 | 235 | 271 | 1.3 | 8 | ● | 2 |
| MPS1-0690-L35C | | 35 | 306 | 242.8 | 267.3 | 269 | 305 | 1.3 | 8 | □ | 2 |
| MPS1-0690-L40C | | 40 | 341 | 277.3 | 301.3 | 304 | 340 | 1.3 | 8 | ● | 2 |

MPS1

VOLLHARTMETALLBOHRER

| Bestellnummer | DC | (l/d) | OAL | LU | LCF | LH | LF | PL | DCON | DP1021 | Typ |
|------------------|-----|-------|-----|-------|-------|-----|------|-----|------|--------|-----|
| MPS1-0700S-DIN | 7 | 3 | 79 | 23.8 | 34 | 43 | 77.7 | 1.3 | 8 | □ | 4 |
| MPS1-0700S-DIN-C | | 3 | 79 | 23.8 | 34 | 43 | 77.7 | 1.3 | 8 | ● | 2 |
| MPS1-0700L-DIN | | 5 | 91 | 42.8 | 53 | 55 | 89.7 | 1.3 | 8 | □ | 4 |
| MPS1-0700L-DIN-C | | 5 | 91 | 42.8 | 53 | 55 | 89.7 | 1.3 | 8 | ● | 2 |
| MPS1-0700-PC | | 2 | 75 | 15.1 | 35.1 | 37 | 74 | 1.1 | 8 | ● | 2 |
| MPS1-0700-L8C | | 8 | 118 | 57.4 | 78 | 81 | 117 | 1.3 | 8 | ● | 2 |
| MPS1-0700-L10C | | 10 | 132 | 71.3 | 92.3 | 95 | 131 | 1.3 | 8 | ● | 2 |
| MPS1-0700-L12C | | 12 | 146 | 85.3 | 106.3 | 109 | 145 | 1.3 | 8 | ● | 2 |
| MPS1-0700-L15C | | 15 | 167 | 106.3 | 127.3 | 130 | 166 | 1.3 | 8 | ● | 2 |
| MPS1-0700-L20C | | 20 | 202 | 141.3 | 162.3 | 165 | 201 | 1.3 | 8 | ● | 2 |
| MPS1-0700-L25C | | 25 | 237 | 176.3 | 197.3 | 200 | 236 | 1.3 | 8 | ● | 2 |
| MPS1-0700-L30C | | 30 | 272 | 211.3 | 232.3 | 235 | 271 | 1.3 | 8 | ● | 2 |
| MPS1-0700-L35C | | 35 | 306 | 246.3 | 267.3 | 269 | 305 | 1.3 | 8 | □ | 2 |
| MPS1-0700-L40C | | 40 | 341 | 281.3 | 301.3 | 304 | 340 | 1.3 | 8 | ● | 2 |
| MPS1-0710S-DIN | 7.1 | 3 | 79 | 30.6 | 41 | 43 | 77.7 | 1.3 | 8 | □ | 4 |
| MPS1-0710S-DIN-C | | 3 | 79 | 30.6 | 41 | 43 | 77.7 | 1.3 | 8 | ● | 2 |
| MPS1-0710L-DIN | | 5 | 91 | 42.6 | 53 | 55 | 89.7 | 1.3 | 8 | □ | 4 |
| MPS1-0710L-DIN-C | | 5 | 91 | 42.6 | 53 | 55 | 89.7 | 1.3 | 8 | ● | 2 |
| MPS1-0710-PC | | 2 | 80 | 15.3 | 35.1 | 38 | 79 | 1.1 | 8 | ● | 2 |
| MPS1-0710-L8C | | 8 | 124 | 58.3 | 84 | 87 | 123 | 1.3 | 8 | ● | 2 |
| MPS1-0710-L10C | | 10 | 139 | 72.3 | 99.3 | 102 | 138 | 1.3 | 8 | □ | 2 |
| MPS1-0710-L12C | | 12 | 154 | 86.5 | 114.3 | 117 | 153 | 1.3 | 8 | ● | 2 |
| MPS1-0710-L15C | | 15 | 176 | 107.8 | 136.3 | 139 | 175 | 1.3 | 8 | ● | 2 |
| MPS1-0710-L20C | | 20 | 214 | 143.3 | 174.3 | 177 | 213 | 1.3 | 8 | ● | 2 |
| MPS1-0710-L25C | | 25 | 251 | 178.8 | 211.3 | 214 | 250 | 1.3 | 8 | ● | 2 |
| MPS1-0710-L30C | | 30 | 289 | 214.3 | 249.3 | 252 | 288 | 1.3 | 8 | ● | 2 |
| MPS1-0710-L35C | | 35 | 325 | 249.8 | 286.3 | 288 | 324 | 1.3 | 8 | □ | 2 |
| MPS1-0710-L40C | | 40 | 360 | 285.3 | 321.3 | 323 | 359 | 1.3 | 8 | ● | 2 |
| MPS1-0720S-DIN | 7.2 | 3 | 79 | 30.5 | 41 | 43 | 77.7 | 1.3 | 8 | □ | 4 |
| MPS1-0720S-DIN-C | | 3 | 79 | 30.5 | 41 | 43 | 77.7 | 1.3 | 8 | ● | 2 |
| MPS1-0720L-DIN | | 5 | 91 | 42.5 | 53 | 55 | 89.7 | 1.3 | 8 | □ | 4 |
| MPS1-0720L-DIN-C | | 5 | 91 | 42.5 | 53 | 55 | 89.7 | 1.3 | 8 | ● | 2 |
| MPS1-0720-PC | | 2 | 80 | 15.5 | 35.1 | 38 | 79 | 1.1 | 8 | ● | 2 |
| MPS1-0720-L8C | | 8 | 124 | 59.1 | 84 | 87 | 123 | 1.3 | 8 | ● | 2 |
| MPS1-0720-L10C | | 10 | 139 | 73.3 | 99.3 | 102 | 138 | 1.3 | 8 | □ | 2 |
| MPS1-0720-L12C | | 12 | 154 | 87.7 | 114.3 | 117 | 153 | 1.3 | 8 | ● | 2 |
| MPS1-0720-L15C | | 15 | 176 | 109.3 | 136.3 | 139 | 175 | 1.3 | 8 | □ | 2 |
| MPS1-0720-L20C | | 20 | 214 | 145.3 | 174.3 | 177 | 213 | 1.3 | 8 | □ | 2 |
| MPS1-0720-L25C | | 25 | 251 | 181.3 | 211.3 | 214 | 250 | 1.3 | 8 | □ | 2 |
| MPS1-0720-L30C | | 30 | 289 | 217.3 | 249.3 | 252 | 288 | 1.3 | 8 | □ | 2 |
| MPS1-0720-L35C | | 35 | 325 | 253.3 | 286.3 | 288 | 324 | 1.3 | 8 | □ | 2 |
| MPS1-0720-L40C | | 40 | 360 | 289.3 | 321.3 | 323 | 359 | 1.3 | 8 | ● | 2 |

MPS1

VOLLHARTMETALLBOHRER

| Bestellnummer | DC | (l/d) | OAL | LU | LCF | LH | LF | PL | DCON | DP1021 | Typ |
|------------------|-----|-------|-----|-------|-------|-----|------|-----|------|--------|-----|
| MPS1-0730S-DIN | 7.3 | 3 | 79 | 30.4 | 41 | 43 | 77.7 | 1.3 | 8 | □ | 4 |
| MPS1-0730S-DIN-C | | 3 | 79 | 30.4 | 41 | 43 | 77.7 | 1.3 | 8 | ● | 2 |
| MPS1-0730L-DIN | | 5 | 91 | 42.4 | 53 | 55 | 89.7 | 1.3 | 8 | □ | 4 |
| MPS1-0730L-DIN-C | | 5 | 91 | 42.4 | 53 | 55 | 89.7 | 1.3 | 8 | ● | 2 |
| MPS1-0730-PC | | 2 | 80 | 15.8 | 35.2 | 38 | 79 | 1.2 | 8 | ● | 2 |
| MPS1-0730-L8C | | 8 | 125 | 59.9 | 84 | 88 | 123 | 1.3 | 8 | ● | 2 |
| MPS1-0730-L10C | | 10 | 139 | 74.3 | 99.3 | 102 | 138 | 1.3 | 8 | □ | 2 |
| MPS1-0730-L12C | | 12 | 154 | 88.9 | 114.3 | 117 | 153 | 1.3 | 8 | ● | 2 |
| MPS1-0730-L15C | | 15 | 176 | 110.8 | 136.3 | 139 | 175 | 1.3 | 8 | □ | 2 |
| MPS1-0730-L20C | | 20 | 214 | 147.3 | 174.3 | 177 | 213 | 1.3 | 8 | □ | 2 |
| MPS1-0730-L25C | | 25 | 251 | 183.8 | 211.3 | 214 | 250 | 1.3 | 8 | □ | 2 |
| MPS1-0730-L30C | | 30 | 289 | 220.3 | 249.3 | 252 | 288 | 1.3 | 8 | □ | 2 |
| MPS1-0730-L35C | | 35 | 325 | 256.8 | 286.3 | 288 | 324 | 1.3 | 8 | □ | 2 |
| MPS1-0730-L40C | | 40 | 360 | 293.3 | 321.3 | 323 | 359 | 1.3 | 8 | ● | 2 |
| MPS1-0740S-DIN | 7.4 | 3 | 79 | 30.2 | 41 | 43 | 77.7 | 1.3 | 8 | □ | 4 |
| MPS1-0740S-DIN-C | | 3 | 79 | 30.2 | 41 | 43 | 77.7 | 1.3 | 8 | ● | 2 |
| MPS1-0740L-DIN | | 5 | 91 | 42.2 | 53 | 55 | 89.7 | 1.3 | 8 | □ | 4 |
| MPS1-0740L-DIN-C | | 5 | 91 | 42.2 | 53 | 55 | 89.7 | 1.3 | 8 | ● | 2 |
| MPS1-0740-PC | | 2 | 80 | 16 | 35.2 | 38 | 79 | 1.2 | 8 | ● | 2 |
| MPS1-0740-L8C | | 8 | 125 | 60.7 | 84 | 88 | 123 | 1.3 | 8 | ● | 2 |
| MPS1-0740-L10C | | 10 | 139 | 75.3 | 99.3 | 102 | 138 | 1.3 | 8 | □ | 2 |
| MPS1-0740-L12C | | 12 | 154 | 90.1 | 114.3 | 117 | 153 | 1.3 | 8 | ● | 2 |
| MPS1-0740-L15C | | 15 | 176 | 112.3 | 136.3 | 139 | 175 | 1.3 | 8 | □ | 2 |
| MPS1-0740-L20C | | 20 | 214 | 149.3 | 174.3 | 177 | 213 | 1.3 | 8 | □ | 2 |
| MPS1-0740-L25C | | 25 | 251 | 186.3 | 211.3 | 214 | 250 | 1.3 | 8 | □ | 2 |
| MPS1-0740-L30C | | 30 | 289 | 223.3 | 249.3 | 252 | 288 | 1.3 | 8 | □ | 2 |
| MPS1-0740-L35C | | 35 | 325 | 260.3 | 286.3 | 288 | 324 | 1.3 | 8 | □ | 2 |
| MPS1-0740-L40C | | 40 | 360 | 297.3 | 321.3 | 323 | 359 | 1.3 | 8 | ● | 2 |
| MPS1-0750S-DIN | 7.5 | 3 | 79 | 30.1 | 41 | 43 | 77.6 | 1.4 | 8 | □ | 4 |
| MPS1-0750S-DIN-C | | 3 | 79 | 30.1 | 41 | 43 | 77.6 | 1.4 | 8 | ● | 2 |
| MPS1-0750L-DIN | | 5 | 91 | 42.1 | 53 | 55 | 89.6 | 1.4 | 8 | □ | 4 |
| MPS1-0750L-DIN-C | | 5 | 91 | 42.1 | 53 | 55 | 89.6 | 1.4 | 8 | ● | 2 |
| MPS1-0750-PC | | 2 | 80 | 16.2 | 35.2 | 38 | 79 | 1.2 | 8 | ● | 2 |
| MPS1-0750-L8C | | 8 | 125 | 61.6 | 84 | 88 | 123 | 1.4 | 8 | ● | 2 |
| MPS1-0750-L10C | | 10 | 139 | 76.4 | 99.4 | 102 | 138 | 1.4 | 8 | □ | 2 |
| MPS1-0750-L12C | | 12 | 154 | 91.4 | 114.4 | 117 | 153 | 1.4 | 8 | ● | 2 |
| MPS1-0750-L15C | | 15 | 176 | 113.9 | 136.4 | 139 | 175 | 1.4 | 8 | ● | 2 |
| MPS1-0750-L20C | | 20 | 214 | 151.4 | 174.4 | 177 | 213 | 1.4 | 8 | ● | 2 |
| MPS1-0750-L25C | | 25 | 251 | 188.9 | 211.4 | 214 | 250 | 1.4 | 8 | ● | 2 |
| MPS1-0750-L30C | | 30 | 289 | 226.4 | 249.4 | 252 | 288 | 1.4 | 8 | ● | 2 |
| MPS1-0750-L35C | | 35 | 325 | 263.9 | 286.4 | 288 | 324 | 1.4 | 8 | □ | 2 |
| MPS1-0750-L40C | | 40 | 360 | 301.4 | 321.4 | 323 | 359 | 1.4 | 8 | ● | 2 |

MPS1

VOLLHARTMETALLBOHRER

| Bestellnummer | DC | (l/d) | OAL | LU | LCF | LH | LF | PL | DCON | DP1021 | Typ |
|------------------|-----|-------|-----|-------|-------|-----|------|-----|------|--------|-----|
| MPS1-0760S-DIN | 7.6 | 3 | 79 | 30.0 | 41 | 43 | 77.6 | 1.4 | 8 | □ | 4 |
| MPS1-0760S-DIN-C | | 3 | 79 | 30.0 | 41 | 43 | 77.6 | 1.4 | 8 | ● | 2 |
| MPS1-0760L-DIN | | 5 | 91 | 42.0 | 53 | 55 | 89.6 | 1.4 | 8 | □ | 4 |
| MPS1-0760L-DIN-C | | 5 | 91 | 42.0 | 53 | 55 | 89.6 | 1.4 | 8 | ● | 2 |
| MPS1-0760-PC | | 2 | 80 | 16.4 | 38.2 | 38 | 79 | 1.2 | 8 | ● | 2 |
| MPS1-0760-L8C | | 8 | 130 | 62.4 | 89 | 93 | 128 | 1.4 | 8 | ● | 2 |
| MPS1-0760-L10C | | 10 | 145 | 77.4 | 105.4 | 108 | 144 | 1.4 | 8 | □ | 2 |
| MPS1-0760-L12C | | 12 | 161 | 92.6 | 121.4 | 124 | 160 | 1.4 | 8 | ● | 2 |
| MPS1-0760-L15C | | 15 | 185 | 115.4 | 145.4 | 148 | 184 | 1.4 | 8 | ● | 2 |
| MPS1-0760-L20C | | 20 | 225 | 153.4 | 185.4 | 188 | 224 | 1.4 | 8 | □ | 2 |
| MPS1-0760-L25C | | 25 | 265 | 191.4 | 225.4 | 228 | 264 | 1.4 | 8 | ● | 2 |
| MPS1-0760-L30C | | 30 | 305 | 229.4 | 265.4 | 268 | 304 | 1.4 | 8 | □ | 2 |
| MPS1-0760-L35C | | 35 | 344 | 267.4 | 305.4 | 307 | 343 | 1.4 | 8 | □ | 2 |
| MPS1-0760-L40C | | 40 | 379 | 305.4 | 341.4 | 342 | 378 | 1.4 | 8 | ● | 2 |
| MPS1-0770S-DIN | 7.7 | 3 | 79 | 29.9 | 41 | 43 | 77.6 | 1.4 | 8 | □ | 4 |
| MPS1-0770S-DIN-C | | 3 | 79 | 29.9 | 41 | 43 | 77.6 | 1.4 | 8 | ● | 2 |
| MPS1-0770L-DIN | | 5 | 91 | 41.9 | 53 | 55 | 89.6 | 1.4 | 8 | □ | 4 |
| MPS1-0770L-DIN-C | | 5 | 91 | 41.9 | 53 | 55 | 89.6 | 1.4 | 8 | ● | 2 |
| MPS1-0770-PC | | 2 | 80 | 16.6 | 38.2 | 38 | 79 | 1.2 | 8 | ● | 2 |
| MPS1-0770-L8C | | 8 | 130 | 63.2 | 89 | 93 | 128 | 1.4 | 8 | ● | 2 |
| MPS1-0770-L10C | | 10 | 145 | 78.4 | 105.4 | 108 | 144 | 1.4 | 8 | □ | 2 |
| MPS1-0770-L12C | | 12 | 161 | 93.8 | 121.4 | 124 | 160 | 1.4 | 8 | ● | 2 |
| MPS1-0770-L15C | | 15 | 185 | 116.9 | 145.4 | 148 | 184 | 1.4 | 8 | ● | 2 |
| MPS1-0770-L20C | | 20 | 225 | 155.4 | 185.4 | 188 | 224 | 1.4 | 8 | □ | 2 |
| MPS1-0770-L25C | | 25 | 265 | 193.9 | 225.4 | 228 | 264 | 1.4 | 8 | ● | 2 |
| MPS1-0770-L30C | | 30 | 305 | 232.4 | 265.4 | 268 | 304 | 1.4 | 8 | □ | 2 |
| MPS1-0770-L35C | | 35 | 344 | 270.9 | 305.4 | 307 | 343 | 1.4 | 8 | □ | 2 |
| MPS1-0770-L40C | | 40 | 379 | 309.4 | 341.4 | 342 | 378 | 1.4 | 8 | ● | 2 |
| MPS1-0780S-DIN | 7.8 | 3 | 79 | 29.7 | 41 | 43 | 77.6 | 1.4 | 8 | □ | 4 |
| MPS1-0780S-DIN-C | | 3 | 79 | 29.7 | 41 | 43 | 77.6 | 1.4 | 8 | ● | 2 |
| MPS1-0780L-DIN | | 5 | 91 | 41.7 | 53 | 55 | 89.6 | 1.4 | 8 | □ | 4 |
| MPS1-0780L-DIN-C | | 5 | 91 | 41.7 | 53 | 55 | 89.6 | 1.4 | 8 | ● | 2 |
| MPS1-0780-PC | | 2 | 80 | 16.8 | 38.2 | 38 | 79 | 1.2 | 8 | ● | 2 |
| MPS1-0780-L8C | | 8 | 130 | 64.0 | 89 | 93 | 128 | 1.4 | 8 | ● | 2 |
| MPS1-0780-L10C | | 10 | 145 | 79.4 | 105.4 | 108 | 144 | 1.4 | 8 | □ | 2 |
| MPS1-0780-L12C | | 12 | 161 | 95 | 121.4 | 124 | 160 | 1.4 | 8 | ● | 2 |
| MPS1-0780-L15C | | 15 | 185 | 118.4 | 145.4 | 148 | 184 | 1.4 | 8 | ● | 2 |
| MPS1-0780-L20C | | 20 | 225 | 157.4 | 185.4 | 188 | 224 | 1.4 | 8 | □ | 2 |
| MPS1-0780-L25C | | 25 | 265 | 196.4 | 225.4 | 228 | 264 | 1.4 | 8 | □ | 2 |
| MPS1-0780-L30C | | 30 | 305 | 235.4 | 265.4 | 268 | 304 | 1.4 | 8 | ● | 2 |
| MPS1-0780-L35C | | 35 | 344 | 274.4 | 305.4 | 307 | 343 | 1.4 | 8 | □ | 2 |
| MPS1-0780-L40C | | 40 | 379 | 313.4 | 341.4 | 342 | 378 | 1.4 | 8 | ● | 2 |

MPS1

VOLLHARTMETALLBOHRER

| Bestellnummer | DC | (l/d) | OAL | LU | LCF | LH | LF | PL | DCON | DP1021 | Typ |
|------------------|------|-------|-----|-------|-------|-----|-------|-----|------|--------|-----|
| MPS1-0790S-DIN | 7.9 | 3 | 79 | 29.6 | 41 | 43 | 77.6 | 1.4 | 8 | □ | 4 |
| MPS1-0790S-DIN-C | | 3 | 79 | 29.6 | 41 | 43 | 77.6 | 1.4 | 8 | ● | 2 |
| MPS1-0790L-DIN | | 5 | 91 | 41.6 | 53 | 55 | 89.6 | 1.4 | 8 | □ | 4 |
| MPS1-0790L-DIN-C | | 5 | 91 | 41.6 | 53 | 55 | 89.6 | 1.4 | 8 | ● | 2 |
| MPS1-0790-PC | | 2 | 80 | 17 | 38.2 | 38 | 79 | 1.2 | 8 | ● | 2 |
| MPS1-0790-L8C | | 8 | 130 | 64.8 | 89 | 93 | 128 | 1.4 | 8 | ● | 2 |
| MPS1-0790-L10C | | 10 | 145 | 80.4 | 105.4 | 108 | 144 | 1.4 | 8 | □ | 2 |
| MPS1-0790-L12C | | 12 | 161 | 96.2 | 121.4 | 124 | 160 | 1.4 | 8 | ● | 2 |
| MPS1-0790-L15C | | 15 | 185 | 119.9 | 145.4 | 148 | 184 | 1.4 | 8 | □ | 2 |
| MPS1-0790-L20C | | 20 | 225 | 159.4 | 185.4 | 188 | 224 | 1.4 | 8 | □ | 2 |
| MPS1-0790-L25C | | 25 | 265 | 198.9 | 225.4 | 228 | 264 | 1.4 | 8 | ● | 2 |
| MPS1-0790-L30C | | 30 | 305 | 238.4 | 265.4 | 268 | 304 | 1.4 | 8 | ● | 2 |
| MPS1-0790-L35C | | 35 | 344 | 277.9 | 305.4 | 307 | 343 | 1.4 | 8 | □ | 2 |
| MPS1-0790-L40C | | 40 | 379 | 317.4 | 341.4 | 342 | 378 | 1.4 | 8 | ● | 2 |
| MPS1-0800S-DIN | 8 | 3 | 79 | 29.5 | 41 | 43 | 77.5 | 1.5 | 8 | □ | 4 |
| MPS1-0800S-DIN-C | | 3 | 79 | 29.5 | 41 | 43 | 77.5 | 1.5 | 8 | ● | 2 |
| MPS1-0800L-DIN | | 5 | 91 | 41.5 | 53 | 55 | 89.5 | 1.5 | 8 | □ | 4 |
| MPS1-0800L-DIN-C | | 5 | 91 | 41.5 | 53 | 55 | 89.5 | 1.5 | 8 | ● | 2 |
| MPS1-0800-PC | | 2 | 80 | 17.3 | 38.3 | 38 | 79 | 1.3 | 8 | ● | 2 |
| MPS1-0800-L8C | | 8 | 130 | 65.7 | 89 | 93 | 128 | 1.5 | 8 | ● | 2 |
| MPS1-0800-L10C | | 10 | 145 | 81.5 | 105.5 | 108 | 144 | 1.5 | 8 | ● | 2 |
| MPS1-0800-L12C | | 12 | 161 | 97.5 | 121.5 | 124 | 160 | 1.5 | 8 | ● | 2 |
| MPS1-0800-L15C | | 15 | 185 | 121.5 | 145.5 | 148 | 184 | 1.5 | 8 | ● | 2 |
| MPS1-0800-L20C | | 20 | 225 | 161.5 | 185.5 | 188 | 224 | 1.5 | 8 | ● | 2 |
| MPS1-0800-L25C | | 25 | 265 | 201.5 | 225.5 | 228 | 264 | 1.5 | 8 | ● | 2 |
| MPS1-0800-L30C | | 30 | 305 | 241.5 | 265.5 | 268 | 304 | 1.5 | 8 | ● | 2 |
| MPS1-0800-L35C | | 35 | 344 | 281.5 | 305.5 | 307 | 343 | 1.5 | 8 | □ | 2 |
| MPS1-0800-L40C | | 40 | 379 | 321.5 | 341.5 | 342 | 378 | 1.5 | 8 | ● | 2 |
| MPS1-0805S-DIN | 8.05 | 3 | 88 | 34.4 | 46 | 48 | 86.5 | 1.5 | 10 | □ | 4 |
| MPS1-0805S-DIN-C | | 3 | 88 | 34.4 | 46 | 48 | 86.5 | 1.5 | 10 | ● | 2 |
| MPS1-0805L-DIN | | 5 | 102 | 48.4 | 60 | 62 | 100.5 | 1.5 | 10 | □ | 4 |
| MPS1-0805L-DIN-C | | 5 | 102 | 48.4 | 60 | 62 | 100.5 | 1.5 | 10 | ● | 2 |
| MPS1-0810S-DIN | 8.1 | 3 | 88 | 34.3 | 46 | 48 | 86.5 | 1.5 | 10 | □ | 4 |
| MPS1-0810S-DIN-C | | 3 | 88 | 34.3 | 46 | 48 | 86.5 | 1.5 | 10 | ● | 2 |
| MPS1-0810L-DIN | | 5 | 102 | 48.3 | 60 | 62 | 100.5 | 1.5 | 10 | □ | 4 |
| MPS1-0810L-DIN-C | | 5 | 102 | 48.3 | 60 | 62 | 100.5 | 1.5 | 10 | ● | 2 |
| MPS1-0810-PC | | 2 | 85 | 17.5 | 38.3 | 41 | 84 | 1.3 | 10 | ● | 2 |
| MPS1-0810-L8C | | 8 | 140 | 66.5 | 95 | 99 | 138 | 1.5 | 10 | ● | 2 |
| MPS1-0810-L10C | | 10 | 156 | 82.5 | 112.5 | 115 | 155 | 1.5 | 10 | □ | 2 |
| MPS1-0810-L12C | | 12 | 173 | 98.7 | 129.5 | 132 | 172 | 1.5 | 10 | ● | 2 |
| MPS1-0810-L15C | | 15 | 198 | 123 | 154.5 | 157 | 197 | 1.5 | 10 | ● | 2 |
| MPS1-0810-L20C | | 20 | 241 | 163.5 | 197.5 | 200 | 240 | 1.5 | 10 | ● | 2 |
| MPS1-0810-L25C | | 25 | 283 | 204 | 239.5 | 242 | 282 | 1.5 | 10 | □ | 2 |
| MPS1-0810-L30C | | 30 | 325 | 244.5 | 282.5 | 284 | 324 | 1.5 | 10 | □ | 2 |
| MPS1-0810-L35C | | 35 | 367 | 285 | 324.5 | 326 | 366 | 1.5 | 10 | □ | 2 |
| MPS1-0810-L40C | | 40 | 411 | 325.5 | 366.5 | 370 | 410 | 1.5 | 10 | ● | 2 |

MPS1

VOLLHARTMETALLBOHRER

| Bestellnummer | DC | (l/d) | OAL | LU | LCF | LH | LF | PL | DCON | DP1021 | Typ |
|------------------|-----|-------|-----|-------|-------|-----|-------|-----|------|--------|-----|
| MPS1-0820S-DIN | 8.2 | 3 | 88 | 34.2 | 46 | 48 | 86.5 | 1.5 | 10 | □ | 4 |
| MPS1-0820S-DIN-C | | 3 | 88 | 34.2 | 46 | 48 | 86.5 | 1.5 | 10 | ● | 2 |
| MPS1-0820L-DIN | | 5 | 102 | 48.2 | 60 | 62 | 100.5 | 1.5 | 10 | □ | 4 |
| MPS1-0820L-DIN-C | | 5 | 102 | 48.2 | 60 | 62 | 100.5 | 1.5 | 10 | ● | 2 |
| MPS1-0820-PC | | 2 | 85 | 17.7 | 38.3 | 41 | 84 | 1.3 | 10 | ● | 2 |
| MPS1-0820-L8C | | 8 | 140 | 67.3 | 95 | 99 | 138 | 1.5 | 10 | ● | 2 |
| MPS1-0820-L10C | | 10 | 156 | 83.5 | 112.5 | 115 | 155 | 1.5 | 10 | □ | 2 |
| MPS1-0820-L12C | | 12 | 173 | 99.9 | 129.5 | 132 | 172 | 1.5 | 10 | ● | 2 |
| MPS1-0820-L15C | | 15 | 198 | 124.5 | 154.5 | 157 | 197 | 1.5 | 10 | ● | 2 |
| MPS1-0820-L20C | | 20 | 241 | 165.5 | 197.5 | 200 | 240 | 1.5 | 10 | ● | 2 |
| MPS1-0820-L25C | | 25 | 283 | 206.5 | 239.5 | 242 | 282 | 1.5 | 10 | □ | 2 |
| MPS1-0820-L30C | | 30 | 325 | 247.5 | 282.5 | 284 | 324 | 1.5 | 10 | □ | 2 |
| MPS1-0820-L35C | | 35 | 367 | 288.5 | 324.5 | 326 | 366 | 1.5 | 10 | □ | 2 |
| MPS1-0820-L40C | | 40 | 411 | 329.5 | 366.5 | 370 | 410 | 1.5 | 10 | ● | 2 |
| MPS1-0830S-DIN | 8.3 | 3 | 88 | 34.1 | 46 | 48 | 86.5 | 1.5 | 10 | □ | 4 |
| MPS1-0830S-DIN-C | | 3 | 88 | 34.1 | 46 | 48 | 86.5 | 1.5 | 10 | ● | 2 |
| MPS1-0830L-DIN | | 5 | 102 | 48.1 | 60 | 62 | 100.5 | 1.5 | 10 | □ | 4 |
| MPS1-0830L-DIN-C | | 5 | 102 | 48.1 | 60 | 62 | 100.5 | 1.5 | 10 | ● | 2 |
| MPS1-0830-PC | | 2 | 85 | 17.9 | 38.3 | 41 | 84 | 1.3 | 10 | ● | 2 |
| MPS1-0830-L8C | | 8 | 140 | 68.1 | 95 | 99 | 138 | 1.5 | 10 | ● | 2 |
| MPS1-0830-L10C | | 10 | 157 | 84.5 | 112.5 | 116 | 155 | 1.5 | 10 | □ | 2 |
| MPS1-0830-L12C | | 12 | 174 | 101.1 | 129.5 | 133 | 172 | 1.5 | 10 | ● | 2 |
| MPS1-0830-L15C | | 15 | 199 | 126 | 154.5 | 158 | 197 | 1.5 | 10 | □ | 2 |
| MPS1-0830-L20C | | 20 | 242 | 167.5 | 197.5 | 201 | 240 | 1.5 | 10 | □ | 2 |
| MPS1-0830-L25C | | 25 | 284 | 209 | 239.5 | 243 | 282 | 1.5 | 10 | □ | 2 |
| MPS1-0830-L30C | | 30 | 326 | 250.5 | 282.5 | 285 | 324 | 1.5 | 10 | □ | 2 |
| MPS1-0830-L35C | | 35 | 368 | 292 | 324.5 | 327 | 366 | 1.5 | 10 | □ | 2 |
| MPS1-0830-L40C | | 40 | 412 | 333.5 | 366.5 | 371 | 410 | 1.5 | 10 | ● | 2 |
| MPS1-0840S-DIN | 8.4 | 3 | 88 | 33.9 | 46 | 48 | 86.5 | 1.5 | 10 | □ | 4 |
| MPS1-0840S-DIN-C | | 3 | 88 | 33.9 | 46 | 48 | 86.5 | 1.5 | 10 | ● | 2 |
| MPS1-0840L-DIN | | 5 | 102 | 47.9 | 60 | 62 | 100.5 | 1.5 | 10 | □ | 4 |
| MPS1-0840L-DIN-C | | 5 | 102 | 47.9 | 60 | 62 | 100.5 | 1.5 | 10 | ● | 2 |
| MPS1-0840-PC | | 2 | 85 | 18.1 | 38.3 | 41 | 84 | 1.3 | 10 | ● | 2 |
| MPS1-0840-L8C | | 8 | 140 | 68.9 | 95 | 99 | 138 | 1.5 | 10 | ● | 2 |
| MPS1-0840-L10C | | 10 | 157 | 85.5 | 112.5 | 116 | 155 | 1.5 | 10 | □ | 2 |
| MPS1-0840-L12C | | 12 | 174 | 102.3 | 129.5 | 133 | 172 | 1.5 | 10 | ● | 2 |
| MPS1-0840-L15C | | 15 | 199 | 127.5 | 154.5 | 158 | 197 | 1.5 | 10 | ● | 2 |
| MPS1-0840-L20C | | 20 | 242 | 169.5 | 197.5 | 201 | 240 | 1.5 | 10 | □ | 2 |
| MPS1-0840-L25C | | 25 | 284 | 211.5 | 239.5 | 243 | 282 | 1.5 | 10 | □ | 2 |
| MPS1-0840-L30C | | 30 | 326 | 253.5 | 282.5 | 285 | 324 | 1.5 | 10 | □ | 2 |
| MPS1-0840-L35C | | 35 | 368 | 295.5 | 324.5 | 327 | 366 | 1.5 | 10 | □ | 2 |
| MPS1-0840-L40C | | 40 | 412 | 337.5 | 366.5 | 371 | 410 | 1.5 | 10 | ● | 2 |

MPS1

VOLLHARTMETALLBOHRER

| Bestellnummer | DC | (l/d) | OAL | LU | LCF | LH | LF | PL | DCON | DP1021 | Typ |
|------------------|-----|-------|-----|-------|-------|-----|-------|------|------|--------|-----|
| MPS1-0850S-DIN | 8.5 | 3 | 88 | 33.8 | 46 | 48 | 86.5 | 1.5 | 10 | □ | 4 |
| MPS1-0850S-DIN-C | | 3 | 88 | 33.8 | 46 | 48 | 86.5 | 1.5 | 10 | ● | 2 |
| MPS1-0850L-DIN | | 5 | 102 | 47.8 | 60 | 62 | 100.5 | 1.5 | 10 | □ | 4 |
| MPS1-0850L-DIN-C | | 5 | 102 | 47.8 | 60 | 62 | 100.5 | 1.5 | 10 | ● | 2 |
| MPS1-0850-PC | | 2 | 85 | 18.3 | 38.3 | 41 | 84 | 1.3 | 10 | ● | 2 |
| MPS1-0850-L8C | | 8 | 140 | 69.8 | 95 | 99 | 138 | 1.5 | 10 | ● | 2 |
| MPS1-0850-L10C | | 10 | 157 | 86.5 | 112.5 | 116 | 155 | 1.5 | 10 | □ | 2 |
| MPS1-0850-L12C | | 12 | 174 | 103.5 | 129.5 | 133 | 172 | 1.5 | 10 | ● | 2 |
| MPS1-0850-L15C | | 15 | 199 | 129 | 154.5 | 158 | 197 | 1.5 | 10 | ● | 2 |
| MPS1-0850-L20C | | 20 | 242 | 171.5 | 197.5 | 201 | 240 | 1.5 | 10 | ● | 2 |
| MPS1-0850-L25C | | 25 | 284 | 214 | 239.5 | 243 | 282 | 1.5 | 10 | ● | 2 |
| MPS1-0850-L30C | | 30 | 326 | 256.5 | 282.5 | 285 | 324 | 1.5 | 10 | ● | 2 |
| MPS1-0850-L35C | | 35 | 368 | 299 | 324.5 | 327 | 366 | 1.5 | 10 | □ | 2 |
| MPS1-0850-L40C | | 40 | 412 | 341.5 | 366.5 | 371 | 410 | 1.5 | 10 | ● | 2 |
| MPS1-0860S-DIN | | 8.6 | 3 | 88 | 33.7 | 46 | 48 | 86.4 | 1.6 | 10 | □ |
| MPS1-0860S-DIN-C | 3 | | 88 | 33.7 | 46 | 48 | 86.4 | 1.6 | 10 | ● | 2 |
| MPS1-0860L-DIN | 5 | | 102 | 47.7 | 60 | 62 | 100.4 | 1.6 | 10 | □ | 4 |
| MPS1-0860L-DIN-C | 5 | | 102 | 47.7 | 60 | 62 | 100.4 | 1.6 | 10 | ● | 2 |
| MPS1-0860-PC | 2 | | 85 | 18.6 | 41.4 | 43 | 84 | 1.4 | 10 | ● | 2 |
| MPS1-0860-L8C | 8 | | 145 | 70.6 | 100 | 104 | 143 | 1.6 | 10 | ● | 2 |
| MPS1-0860-L10C | 10 | | 163 | 87.6 | 118.6 | 122 | 161 | 1.6 | 10 | □ | 2 |
| MPS1-0860-L12C | 12 | | 181 | 104.8 | 136.6 | 140 | 179 | 1.6 | 10 | ● | 2 |
| MPS1-0860-L15C | 15 | | 208 | 130.6 | 163.6 | 167 | 206 | 1.6 | 10 | ● | 2 |
| MPS1-0860-L20C | 20 | | 253 | 173.6 | 208.6 | 212 | 251 | 1.6 | 10 | □ | 2 |
| MPS1-0860-L25C | 25 | | 298 | 216.6 | 253.6 | 257 | 296 | 1.6 | 10 | ● | 2 |
| MPS1-0860-L30C | 30 | | 342 | 259.6 | 298.6 | 301 | 340 | 1.6 | 10 | ● | 2 |
| MPS1-0860-L35C | 35 | | 387 | 302.6 | 343.6 | 346 | 385 | 1.6 | 10 | □ | 2 |
| MPS1-0860-L40C | 40 | | 436 | 345.6 | 391.6 | 395 | 434 | 1.6 | 10 | ● | 2 |
| MPS1-0870S-DIN | 8.7 | | 3 | 88 | 33.5 | 46 | 48 | 86.4 | 1.6 | 10 | □ |
| MPS1-0870S-DIN-C | | 3 | 88 | 33.5 | 46 | 48 | 86.4 | 1.6 | 10 | ● | 2 |
| MPS1-0870L-DIN | | 5 | 102 | 47.5 | 60 | 62 | 100.4 | 1.6 | 10 | □ | 4 |
| MPS1-0870L-DIN-C | | 5 | 102 | 47.5 | 60 | 62 | 100.4 | 1.6 | 10 | ● | 2 |
| MPS1-0870-PC | | 2 | 85 | 18.8 | 41.4 | 43 | 84 | 1.4 | 10 | ● | 2 |
| MPS1-0870-L8C | | 8 | 145 | 71.4 | 100 | 104 | 143 | 1.6 | 10 | ● | 2 |
| MPS1-0870-L10C | | 10 | 163 | 88.6 | 118.6 | 122 | 161 | 1.6 | 10 | □ | 2 |
| MPS1-0870-L12C | | 12 | 181 | 106 | 136.6 | 140 | 179 | 1.6 | 10 | ● | 2 |
| MPS1-0870-L15C | | 15 | 208 | 132.1 | 163.6 | 167 | 206 | 1.6 | 10 | ● | 2 |
| MPS1-0870-L20C | | 20 | 253 | 175.6 | 208.6 | 212 | 251 | 1.6 | 10 | □ | 2 |
| MPS1-0870-L25C | | 25 | 298 | 219.1 | 253.6 | 257 | 296 | 1.6 | 10 | ● | 2 |
| MPS1-0870-L30C | | 30 | 342 | 262.6 | 298.6 | 301 | 340 | 1.6 | 10 | □ | 2 |
| MPS1-0870-L35C | | 35 | 387 | 306.1 | 343.6 | 346 | 385 | 1.6 | 10 | □ | 2 |
| MPS1-0870-L40C | | 40 | 436 | 349.6 | 391.6 | 395 | 434 | 1.6 | 10 | ● | 2 |

MPS1

VOLLHARTMETALLBOHRER

| Bestellnummer | DC | (l/d) | OAL | LU | LCF | LH | LF | PL | DCON | DP1021 | Typ | |
|------------------|-----|-------|-----|-------|-------|-----|-------|------|------|--------|-----|---|
| MPS1-0880S-DIN | 8.8 | 3 | 88 | 33.4 | 46 | 48 | 86.4 | 1.6 | 10 | □ | 4 | |
| MPS1-0880S-DIN-C | | 3 | 88 | 33.4 | 46 | 48 | 86.4 | 1.6 | 10 | ● | 2 | |
| MPS1-0880L-DIN | | 5 | 102 | 47.4 | 60 | 62 | 100.4 | 1.6 | 10 | □ | 4 | |
| MPS1-0880L-DIN-C | | 5 | 102 | 47.4 | 60 | 62 | 100.4 | 1.6 | 10 | ● | 2 | |
| MPS1-0880-PC | | 2 | 85 | 19 | 41.4 | 43 | 84 | 1.4 | 10 | ● | 2 | |
| MPS1-0880-L8C | | 8 | 145 | 72.2 | 100 | 104 | 143 | 1.6 | 10 | ● | 2 | |
| MPS1-0880-L10C | | 10 | 163 | 89.6 | 118.6 | 122 | 161 | 1.6 | 10 | □ | 2 | |
| MPS1-0880-L12C | | 12 | 181 | 107.2 | 136.6 | 140 | 179 | 1.6 | 10 | ● | 2 | |
| MPS1-0880-L15C | | 15 | 208 | 133.6 | 163.6 | 167 | 206 | 1.6 | 10 | ● | 2 | |
| MPS1-0880-L20C | | 20 | 253 | 177.6 | 208.6 | 212 | 251 | 1.6 | 10 | ● | 2 | |
| MPS1-0880-L25C | | 25 | 298 | 221.6 | 253.6 | 257 | 296 | 1.6 | 10 | ● | 2 | |
| MPS1-0880-L30C | | 30 | 342 | 265.6 | 298.6 | 301 | 340 | 1.6 | 10 | ● | 2 | |
| MPS1-0880-L35C | | 35 | 387 | 309.6 | 343.6 | 346 | 385 | 1.6 | 10 | □ | 2 | |
| MPS1-0880-L40C | | 40 | 436 | 353.6 | 391.6 | 395 | 434 | 1.6 | 10 | ● | 2 | |
| MPS1-0890S-DIN | | 8.9 | 3 | 88 | 33.3 | 46 | 48 | 86.4 | 1.6 | 10 | □ | 4 |
| MPS1-0890S-DIN-C | | | 3 | 88 | 33.3 | 46 | 48 | 86.4 | 1.6 | 10 | ● | 2 |
| MPS1-0890L-DIN | 5 | | 102 | 47.3 | 60 | 62 | 100.4 | 1.6 | 10 | □ | 4 | |
| MPS1-0890L-DIN-C | 5 | | 102 | 47.3 | 60 | 62 | 100.4 | 1.6 | 10 | ● | 2 | |
| MPS1-0890-PC | 2 | | 85 | 19.2 | 41.4 | 43 | 84 | 1.4 | 10 | ● | 2 | |
| MPS1-0890-L8C | 8 | | 145 | 73.0 | 100 | 104 | 143 | 1.6 | 10 | ● | 2 | |
| MPS1-0890-L10C | 10 | | 163 | 90.6 | 118.6 | 122 | 161 | 1.6 | 10 | □ | 2 | |
| MPS1-0890-L12C | 12 | | 181 | 108.4 | 136.6 | 140 | 179 | 1.6 | 10 | ● | 2 | |
| MPS1-0890-L15C | 15 | | 208 | 135.1 | 163.6 | 167 | 206 | 1.6 | 10 | □ | 2 | |
| MPS1-0890-L20C | 20 | | 253 | 179.6 | 208.6 | 212 | 251 | 1.6 | 10 | □ | 2 | |
| MPS1-0890-L25C | 25 | | 298 | 224.1 | 253.6 | 257 | 296 | 1.6 | 10 | □ | 2 | |
| MPS1-0890-L30C | 30 | | 342 | 268.6 | 298.6 | 301 | 340 | 1.6 | 10 | □ | 2 | |
| MPS1-0890-L35C | 35 | | 387 | 313.1 | 343.6 | 346 | 385 | 1.6 | 10 | □ | 2 | |
| MPS1-0890-L40C | 40 | | 436 | 357.6 | 391.6 | 395 | 434 | 1.6 | 10 | ● | 2 | |
| MPS1-0900S-DIN | 9 | | 3 | 88 | 33.1 | 46 | 48 | 86.4 | 1.6 | 10 | □ | 4 |
| MPS1-0900S-DIN-C | | | 3 | 88 | 33.1 | 46 | 48 | 86.4 | 1.6 | 10 | ● | 2 |
| MPS1-0900L-DIN | | 5 | 102 | 47.1 | 60 | 62 | 100.4 | 1.6 | 10 | □ | 4 | |
| MPS1-0900L-DIN-C | | 5 | 102 | 47.1 | 60 | 62 | 100.4 | 1.6 | 10 | ● | 2 | |
| MPS1-0900-PC | | 2 | 85 | 19.4 | 41.4 | 43 | 84 | 1.4 | 10 | ● | 2 | |
| MPS1-0900-L8C | | 8 | 145 | 73.9 | 100 | 104 | 143 | 1.6 | 10 | ● | 2 | |
| MPS1-0900-L10C | | 10 | 163 | 91.6 | 118.6 | 122 | 161 | 1.6 | 10 | ● | 2 | |
| MPS1-0900-L12C | | 12 | 181 | 109.6 | 136.6 | 140 | 179 | 1.6 | 10 | ● | 2 | |
| MPS1-0900-L15C | | 15 | 208 | 136.6 | 163.6 | 167 | 206 | 1.6 | 10 | ● | 2 | |
| MPS1-0900-L20C | | 20 | 253 | 181.6 | 208.6 | 212 | 251 | 1.6 | 10 | ● | 2 | |
| MPS1-0900-L25C | | 25 | 298 | 226.6 | 253.6 | 257 | 296 | 1.6 | 10 | ● | 2 | |
| MPS1-0900-L30C | | 30 | 342 | 271.6 | 298.6 | 301 | 340 | 1.6 | 10 | ● | 2 | |
| MPS1-0900-L35C | | 35 | 387 | 316.6 | 343.6 | 346 | 385 | 1.6 | 10 | □ | 2 | |
| MPS1-0900-L40C | | 40 | 436 | 361.6 | 391.6 | 395 | 434 | 1.6 | 10 | ● | 2 | |

MPS1

VOLLHARTMETALLBOHRER

| Bestellnummer | DC | (l/d) | OAL | LU | LCF | LH | LF | PL | DCON | DP1021 | Typ |
|------------------|-----|-------|-----|-------|-------|-----|-------|-----|------|--------|-----|
| MPS1-0910S-DIN | | 3 | 89 | 33.0 | 47 | 49 | 87.3 | 1.7 | 10 | □ | 4 |
| MPS1-0910S-DIN-C | | 3 | 89 | 33.0 | 47 | 49 | 87.3 | 1.7 | 10 | ● | 2 |
| MPS1-0910L-DIN | | 5 | 103 | 47.0 | 62 | 63 | 101.3 | 1.7 | 10 | □ | 4 |
| MPS1-0910L-DIN-C | | 5 | 103 | 47.0 | 62 | 63 | 101.3 | 1.7 | 10 | ● | 2 |
| MPS1-0910-PC | | 2 | 90 | 19.6 | 41.4 | 44 | 89 | 1.4 | 10 | ● | 2 |
| MPS1-0910-L8C | | 8 | 151 | 74.7 | 107 | 110 | 149 | 1.7 | 10 | ● | 2 |
| MPS1-0910-L10C | 9.1 | 10 | 170 | 92.7 | 125.7 | 129 | 168 | 1.7 | 10 | □ | 2 |
| MPS1-0910-L12C | | 12 | 189 | 110.9 | 144.7 | 148 | 187 | 1.7 | 10 | ● | 2 |
| MPS1-0910-L15C | | 15 | 217 | 138.2 | 172.7 | 176 | 215 | 1.7 | 10 | ● | 2 |
| MPS1-0910-L20C | | 20 | 265 | 183.7 | 220.7 | 224 | 263 | 1.7 | 10 | □ | 2 |
| MPS1-0910-L25C | | 25 | 312 | 229.2 | 267.7 | 271 | 310 | 1.7 | 10 | □ | 2 |
| MPS1-0910-L30C | | 30 | 360 | 274.7 | 315.7 | 319 | 358 | 1.7 | 10 | ● | 2 |
| MPS1-0910-L35C | | 35 | 406 | 320.2 | 362.7 | 365 | 404 | 1.7 | 10 | □ | 2 |
| MPS1-0920S-DIN | | 3 | 89 | 32.9 | 47 | 49 | 87.3 | 1.7 | 10 | □ | 4 |
| MPS1-0920S-DIN-C | | 3 | 89 | 32.9 | 47 | 49 | 87.3 | 1.7 | 10 | ● | 2 |
| MPS1-0920L-DIN | | 5 | 103 | 46.9 | 62 | 63 | 101.3 | 1.7 | 10 | □ | 4 |
| MPS1-0920L-DIN-C | | 5 | 103 | 46.9 | 62 | 63 | 101.3 | 1.7 | 10 | ● | 2 |
| MPS1-0920-PC | | 2 | 90 | 19.9 | 41.5 | 44 | 89 | 1.5 | 10 | ● | 2 |
| MPS1-0920-L8C | | 8 | 151 | 75.5 | 107 | 110 | 149 | 1.7 | 10 | ● | 2 |
| MPS1-0920-L10C | 9.2 | 10 | 170 | 93.7 | 125.7 | 129 | 168 | 1.7 | 10 | □ | 2 |
| MPS1-0920-L12C | | 12 | 189 | 112.1 | 144.7 | 148 | 187 | 1.7 | 10 | ● | 2 |
| MPS1-0920-L15C | | 15 | 217 | 139.7 | 172.7 | 176 | 215 | 1.7 | 10 | ● | 2 |
| MPS1-0920-L20C | | 20 | 265 | 185.7 | 220.7 | 224 | 263 | 1.7 | 10 | □ | 2 |
| MPS1-0920-L25C | | 25 | 312 | 231.7 | 267.7 | 271 | 310 | 1.7 | 10 | □ | 2 |
| MPS1-0920-L30C | | 30 | 360 | 277.7 | 315.7 | 319 | 358 | 1.7 | 10 | □ | 2 |
| MPS1-0920-L35C | | 35 | 406 | 323.7 | 362.7 | 365 | 404 | 1.7 | 10 | □ | 2 |
| MPS1-0930S-DIN | | 3 | 89 | 32.7 | 47 | 49 | 87.3 | 1.7 | 10 | □ | 4 |
| MPS1-0930S-DIN-C | | 3 | 89 | 32.7 | 47 | 49 | 87.3 | 1.7 | 10 | ● | 2 |
| MPS1-0930L-DIN | | 5 | 103 | 46.7 | 62 | 63 | 101.3 | 1.7 | 10 | □ | 4 |
| MPS1-0930L-DIN-C | | 5 | 103 | 46.7 | 62 | 63 | 101.3 | 1.7 | 10 | ● | 2 |
| MPS1-0930-PC | | 2 | 90 | 20.1 | 41.5 | 44 | 89 | 1.5 | 10 | ● | 2 |
| MPS1-0930-L8C | | 8 | 151 | 76.3 | 107 | 110 | 149 | 1.7 | 10 | ● | 2 |
| MPS1-0930-L10C | 9.3 | 10 | 170 | 94.7 | 125.7 | 129 | 168 | 1.7 | 10 | □ | 2 |
| MPS1-0930-L12C | | 12 | 189 | 113.3 | 144.7 | 148 | 187 | 1.7 | 10 | ● | 2 |
| MPS1-0930-L15C | | 15 | 217 | 141.2 | 172.7 | 176 | 215 | 1.7 | 10 | □ | 2 |
| MPS1-0930-L20C | | 20 | 265 | 187.7 | 220.7 | 224 | 263 | 1.7 | 10 | □ | 2 |
| MPS1-0930-L25C | | 25 | 312 | 234.2 | 267.7 | 271 | 310 | 1.7 | 10 | □ | 2 |
| MPS1-0930-L30C | | 30 | 360 | 280.7 | 315.7 | 319 | 358 | 1.7 | 10 | □ | 2 |
| MPS1-0930-L35C | | 35 | 406 | 327.2 | 362.7 | 365 | 404 | 1.7 | 10 | □ | 2 |



MPS1

VOLLHARTMETALLBOHRER

| Bestellnummer | DC | (l/d) | OAL | LU | LCF | LH | LF | PL | DCON | DP1021 | Typ |
|------------------|-----|-------|-----|-------|-------|-----|-------|-----|------|--------|-----|
| MPS1-0940S-DIN | | 3 | 89 | 32.6 | 47 | 49 | 87.3 | 1.7 | 10 | □ | 4 |
| MPS1-0940S-DIN-C | | 3 | 89 | 32.6 | 47 | 49 | 87.3 | 1.7 | 10 | ● | 2 |
| MPS1-0940L-DIN | | 5 | 103 | 46.6 | 62 | 63 | 101.3 | 1.7 | 10 | □ | 4 |
| MPS1-0940L-DIN-C | | 5 | 103 | 46.6 | 62 | 63 | 101.3 | 1.7 | 10 | ● | 2 |
| MPS1-0940-PC | | 2 | 90 | 20.3 | 41.5 | 44 | 89 | 1.5 | 10 | ● | 2 |
| MPS1-0940-L8C | | 8 | 151 | 77.1 | 107 | 110 | 149 | 1.7 | 10 | ● | 2 |
| MPS1-0940-L10C | 9.4 | 10 | 170 | 95.7 | 125.7 | 129 | 168 | 1.7 | 10 | □ | 2 |
| MPS1-0940-L12C | | 12 | 189 | 114.5 | 144.7 | 148 | 187 | 1.7 | 10 | ● | 2 |
| MPS1-0940-L15C | | 15 | 216 | 142.7 | 172.7 | 175 | 215 | 1.7 | 10 | □ | 2 |
| MPS1-0940-L20C | | 20 | 264 | 189.7 | 220.7 | 223 | 263 | 1.7 | 10 | □ | 2 |
| MPS1-0940-L25C | | 25 | 311 | 236.7 | 267.7 | 270 | 310 | 1.7 | 10 | □ | 2 |
| MPS1-0940-L30C | | 30 | 359 | 283.7 | 315.7 | 318 | 358 | 1.7 | 10 | □ | 2 |
| MPS1-0940-L35C | | 35 | 406 | 330.7 | 362.7 | 365 | 404 | 1.7 | 10 | □ | 2 |
| MPS1-0950S-DIN | | 3 | 89 | 32.5 | 47 | 49 | 87.3 | 1.7 | 10 | □ | 4 |
| MPS1-0950S-DIN-C | | 3 | 89 | 32.5 | 47 | 49 | 87.3 | 1.7 | 10 | ● | 2 |
| MPS1-0950L-DIN | | 5 | 103 | 46.5 | 62 | 63 | 101.3 | 1.7 | 10 | □ | 4 |
| MPS1-0950L-DIN-C | | 5 | 103 | 46.5 | 62 | 63 | 101.3 | 1.7 | 10 | ● | 2 |
| MPS1-0950-PC | | 2 | 90 | 20.5 | 41.5 | 44 | 89 | 1.5 | 10 | ● | 2 |
| MPS1-0950-L8C | | 8 | 151 | 78.0 | 107 | 110 | 149 | 1.7 | 10 | ● | 2 |
| MPS1-0950-L10C | 9.5 | 10 | 169 | 96.7 | 125.7 | 128 | 168 | 1.7 | 10 | □ | 2 |
| MPS1-0950-L12C | | 12 | 188 | 115.7 | 144.7 | 147 | 187 | 1.7 | 10 | ● | 2 |
| MPS1-0950-L15C | | 15 | 216 | 144.2 | 172.7 | 175 | 215 | 1.7 | 10 | ● | 2 |
| MPS1-0950-L20C | | 20 | 265 | 191.7 | 220.7 | 224 | 263 | 1.7 | 10 | ● | 2 |
| MPS1-0950-L25C | | 25 | 311 | 239.2 | 267.7 | 270 | 310 | 1.7 | 10 | ● | 2 |
| MPS1-0950-L30C | | 30 | 359 | 286.7 | 315.7 | 318 | 358 | 1.7 | 10 | ● | 2 |
| MPS1-0950-L35C | | 35 | 405 | 334.2 | 362.7 | 364 | 404 | 1.7 | 10 | □ | 2 |
| MPS1-0960S-DIN | | 3 | 89 | 32.3 | 47 | 49 | 87.3 | 1.7 | 10 | □ | 4 |
| MPS1-0960S-DIN-C | | 3 | 89 | 32.3 | 47 | 49 | 87.3 | 1.7 | 10 | ● | 2 |
| MPS1-0960L-DIN | | 5 | 103 | 46.3 | 62 | 63 | 101.3 | 1.7 | 10 | □ | 4 |
| MPS1-0960L-DIN-C | | 5 | 103 | 46.3 | 62 | 63 | 101.3 | 1.7 | 10 | ● | 2 |
| MPS1-0960-PC | | 2 | 90 | 20.7 | 44.5 | 44 | 89 | 1.5 | 10 | ● | 2 |
| MPS1-0960-L8C | | 8 | 156 | 78.8 | 112 | 115 | 154 | 1.7 | 10 | ● | 2 |
| MPS1-0960-L10C | 9.6 | 10 | 176 | 97.7 | 131.7 | 135 | 174 | 1.7 | 10 | □ | 2 |
| MPS1-0960-L12C | | 12 | 195 | 116.9 | 151.7 | 154 | 194 | 1.7 | 10 | ● | 2 |
| MPS1-0960-L15C | | 15 | 225 | 145.7 | 181.7 | 184 | 224 | 1.7 | 10 | ● | 2 |
| MPS1-0960-L20C | | 20 | 275 | 193.7 | 231.7 | 234 | 274 | 1.7 | 10 | □ | 2 |
| MPS1-0960-L25C | | 25 | 325 | 241.7 | 281.7 | 284 | 324 | 1.7 | 10 | □ | 2 |
| MPS1-0960-L30C | | 30 | 375 | 289.7 | 331.7 | 334 | 374 | 1.7 | 10 | □ | 2 |
| MPS1-0960-L35C | | 35 | 424 | 337.7 | 381.7 | 383 | 423 | 1.7 | 10 | □ | 2 |

MPS1

VOLLHARTMETALLBOHRER

| Bestellnummer | DC | (l/d) | OAL | LU | LCF | LH | LF | PL | DCON | DP1021 | Typ |
|------------------|-----|-------|-----|-------|-------|-----|-------|------|------|--------|-----|
| MPS1-0970S-DIN | 9.7 | 3 | 89 | 32.2 | 47 | 49 | 87.2 | 1.8 | 10 | □ | 4 |
| MPS1-0970S-DIN-C | | 3 | 89 | 32.2 | 47 | 49 | 87.2 | 1.8 | 10 | ● | 2 |
| MPS1-0970L-DIN | | 5 | 103 | 46.2 | 62 | 63 | 101.2 | 1.8 | 10 | □ | 4 |
| MPS1-0970L-DIN-C | | 5 | 103 | 46.2 | 62 | 63 | 101.2 | 1.8 | 10 | ● | 2 |
| MPS1-0970-PC | | 2 | 90 | 20.9 | 44.5 | 44 | 89 | 1.5 | 10 | ● | 2 |
| MPS1-0970-L8C | | 8 | 156 | 79.6 | 112 | 115 | 154 | 1.8 | 10 | ● | 2 |
| MPS1-0970-L10C | | 10 | 175 | 98.8 | 131.8 | 134 | 174 | 1.8 | 10 | □ | 2 |
| MPS1-0970-L12C | | 12 | 195 | 118.2 | 151.8 | 154 | 194 | 1.8 | 10 | ● | 2 |
| MPS1-0970-L15C | | 15 | 225 | 147.3 | 181.8 | 184 | 224 | 1.8 | 10 | ● | 2 |
| MPS1-0970-L20C | | 20 | 275 | 195.8 | 231.8 | 234 | 274 | 1.8 | 10 | □ | 2 |
| MPS1-0970-L25C | | 25 | 325 | 244.3 | 281.8 | 284 | 324 | 1.8 | 10 | □ | 2 |
| MPS1-0970-L30C | | 30 | 376 | 292.8 | 331.8 | 335 | 374 | 1.8 | 10 | □ | 2 |
| MPS1-0970-L35C | | 35 | 425 | 341.3 | 381.8 | 384 | 423 | 1.8 | 10 | □ | 2 |
| MPS1-0980S-DIN | | 9.8 | 3 | 89 | 32.1 | 47 | 49 | 87.2 | 1.8 | 10 | □ |
| MPS1-0980S-DIN-C | 3 | | 89 | 32.1 | 47 | 49 | 87.2 | 1.8 | 10 | ● | 2 |
| MPS1-0980L-DIN | 5 | | 103 | 46.1 | 62 | 63 | 101.2 | 1.8 | 10 | □ | 4 |
| MPS1-0980L-DIN-C | 5 | | 103 | 46.1 | 62 | 63 | 101.2 | 1.8 | 10 | ● | 2 |
| MPS1-0980-PC | 2 | | 91 | 21.1 | 44.5 | 45 | 89 | 1.5 | 10 | ● | 2 |
| MPS1-0980-L8C | 8 | | 156 | 80.4 | 112 | 115 | 154 | 1.8 | 10 | ● | 2 |
| MPS1-0980-L10C | 10 | | 176 | 99.8 | 131.8 | 135 | 174 | 1.8 | 10 | □ | 2 |
| MPS1-0980-L12C | 12 | | 196 | 119.4 | 151.8 | 155 | 194 | 1.8 | 10 | ● | 2 |
| MPS1-0980-L15C | 15 | | 226 | 148.8 | 181.8 | 185 | 224 | 1.8 | 10 | ● | 2 |
| MPS1-0980-L20C | 20 | | 276 | 197.8 | 231.8 | 235 | 274 | 1.8 | 10 | ● | 2 |
| MPS1-0980-L25C | 25 | | 326 | 246.8 | 281.8 | 285 | 324 | 1.8 | 10 | □ | 2 |
| MPS1-0980-L30C | 30 | | 376 | 295.8 | 331.8 | 335 | 374 | 1.8 | 10 | ● | 2 |
| MPS1-0980-L35C | 35 | | 425 | 344.8 | 381.8 | 384 | 423 | 1.8 | 10 | □ | 2 |
| MPS1-0990S-DIN | 9.9 | | 3 | 89 | 32.0 | 47 | 49 | 87.2 | 1.8 | 10 | □ |
| MPS1-0990S-DIN-C | | 3 | 89 | 32.0 | 47 | 49 | 87.2 | 1.8 | 10 | ● | 2 |
| MPS1-0990L-DIN | | 5 | 103 | 46.0 | 62 | 63 | 101.2 | 1.8 | 10 | □ | 4 |
| MPS1-0990L-DIN-C | | 5 | 103 | 46.0 | 62 | 63 | 101.2 | 1.8 | 10 | ● | 2 |
| MPS1-0990-PC | | 2 | 91 | 21.4 | 44.6 | 45 | 89 | 1.6 | 10 | ● | 2 |
| MPS1-0990-L8C | | 8 | 156 | 81.3 | 112 | 115 | 154 | 1.8 | 10 | ● | 2 |
| MPS1-0990-L10C | | 10 | 176 | 100.8 | 131.8 | 135 | 174 | 1.8 | 10 | □ | 2 |
| MPS1-0990-L12C | | 12 | 196 | 120.6 | 151.8 | 155 | 194 | 1.8 | 10 | ● | 2 |
| MPS1-0990-L15C | | 15 | 226 | 150.3 | 181.8 | 185 | 224 | 1.8 | 10 | ● | 2 |
| MPS1-0990-L20C | | 20 | 276 | 199.8 | 231.8 | 235 | 274 | 1.8 | 10 | □ | 2 |
| MPS1-0990-L25C | | 25 | 326 | 249.3 | 281.8 | 285 | 324 | 1.8 | 10 | □ | 2 |
| MPS1-0990-L30C | | 30 | 376 | 298.8 | 331.8 | 335 | 374 | 1.8 | 10 | □ | 2 |
| MPS1-0990-L35C | | 35 | 425 | 348.3 | 381.8 | 384 | 423 | 1.8 | 10 | □ | 2 |



MPS1

VOLLHARTMETALLBOHRER

| Bestellnummer | DC | (l/d) | OAL | LU | LCF | LH | LF | PL | DCON | DP1021 | Typ | |
|------------------|------|-------|-----|-------|-------|-----|-------|-------|------|--------|-----|---|
| MPS1-1000S-DIN | 10 | 3 | 89 | 31.8 | 47 | 49 | 87.2 | 1.8 | 10 | □ | 4 | |
| MPS1-1000S-DIN-C | | 3 | 89 | 31.8 | 47 | 49 | 87.2 | 1.8 | 10 | ● | 2 | |
| MPS1-1000L-DIN | | 5 | 103 | 45.8 | 62 | 63 | 101.2 | 1.8 | 10 | □ | 4 | |
| MPS1-1000L-DIN-C | | 5 | 103 | 45.8 | 62 | 63 | 101.2 | 1.8 | 10 | ● | 2 | |
| MPS1-1000-PC | | 2 | 91 | 21.6 | 44.6 | 45 | 89 | 1.6 | 10 | ● | 2 | |
| MPS1-1000-L8C | | 8 | 156 | 82.1 | 112 | 115 | 154 | 1.8 | 10 | ● | 2 | |
| MPS1-1000-L10C | | 10 | 176 | 101.8 | 131.8 | 135 | 174 | 1.8 | 10 | ● | 2 | |
| MPS1-1000-L12C | | 12 | 196 | 121.8 | 151.8 | 155 | 194 | 1.8 | 10 | ● | 2 | |
| MPS1-1000-L15C | | 15 | 226 | 151.8 | 181.8 | 185 | 224 | 1.8 | 10 | ● | 2 | |
| MPS1-1000-L20C | | 20 | 276 | 201.8 | 231.8 | 235 | 274 | 1.8 | 10 | ● | 2 | |
| MPS1-1000-L25C | | 25 | 326 | 251.8 | 281.8 | 285 | 324 | 1.8 | 10 | ● | 2 | |
| MPS1-1000-L30C | | 30 | 376 | 301.8 | 331.8 | 335 | 374 | 1.8 | 10 | ● | 2 | |
| MPS1-1000-L35C | | 35 | 425 | 351.8 | 381.8 | 384 | 423 | 1.8 | 10 | □ | 2 | |
| MPS1-1005S-DIN | | 10.05 | 3 | 102 | 39.8 | 55 | 57 | 100.2 | 1.8 | 12 | □ | 4 |
| MPS1-1005S-DIN-C | | | 3 | 102 | 39.8 | 55 | 57 | 100.2 | 1.8 | 12 | ● | 2 |
| MPS1-1005L-DIN | 5 | | 118 | 55.8 | 71 | 73 | 116.2 | 1.8 | 12 | □ | 4 | |
| MPS1-1005L-DIN-C | 5 | | 118 | 55.8 | 71 | 73 | 116.2 | 1.8 | 12 | ● | 2 | |
| MPS1-1010S-DIN | 10.1 | | 3 | 102 | 39.7 | 55 | 57 | 100.2 | 1.8 | 12 | □ | 4 |
| MPS1-1010S-DIN-C | | | 3 | 102 | 39.7 | 55 | 57 | 100.2 | 1.8 | 12 | ● | 2 |
| MPS1-1010L-DIN | | 5 | 118 | 55.7 | 71 | 73 | 116.2 | 1.8 | 12 | □ | 4 | |
| MPS1-1010L-DIN-C | | 5 | 118 | 55.7 | 71 | 73 | 116.2 | 1.8 | 12 | ● | 2 | |
| MPS1-1010-PC | | 2 | 97 | 21.8 | 44.6 | 48 | 95 | 1.6 | 12 | ● | 2 | |
| MPS1-1010-L8C | | 8 | 167 | 82.9 | 118 | 121 | 165 | 1.8 | 12 | ● | 2 | |
| MPS1-1010-L10C | | 10 | 188 | 102.8 | 138.8 | 142 | 186 | 1.8 | 12 | □ | 2 | |
| MPS1-1010-L12C | | 12 | 209 | 123 | 159.8 | 163 | 207 | 1.8 | 12 | ● | 2 | |
| MPS1-1010-L15C | | 15 | 240 | 153.3 | 190.8 | 194 | 238 | 1.8 | 12 | ● | 2 | |
| MPS1-1010-L20C | | 20 | 293 | 203.8 | 243.8 | 247 | 291 | 1.8 | 12 | ● | 2 | |
| MPS1-1010-L25C | | 25 | 345 | 254.3 | 295.8 | 299 | 343 | 1.8 | 12 | □ | 2 | |
| MPS1-1020S-DIN | | 10.2 | 3 | 102 | 39.6 | 55 | 57 | 100.1 | 1.9 | 12 | □ | 4 |
| MPS1-1020S-DIN-C | 3 | | 102 | 39.6 | 55 | 57 | 100.1 | 1.9 | 12 | ● | 2 | |
| MPS1-1020L-DIN | 5 | | 118 | 55.6 | 71 | 73 | 116.1 | 1.9 | 12 | □ | 4 | |
| MPS1-1020L-DIN-C | 5 | | 118 | 55.6 | 71 | 73 | 116.1 | 1.9 | 12 | ● | 2 | |
| MPS1-1020-PC | 2 | | 96 | 22 | 44.6 | 47 | 95 | 1.6 | 12 | ● | 2 | |
| MPS1-1020-L8C | 8 | | 167 | 83.7 | 118 | 121 | 165 | 1.9 | 12 | ● | 2 | |
| MPS1-1020-L10C | 10 | | 187 | 103.9 | 138.9 | 141 | 186 | 1.9 | 12 | □ | 2 | |
| MPS1-1020-L12C | 12 | | 208 | 124.3 | 159.9 | 162 | 207 | 1.9 | 12 | ● | 2 | |
| MPS1-1020-L15C | 15 | | 239 | 154.9 | 190.9 | 193 | 238 | 1.9 | 12 | ● | 2 | |
| MPS1-1020-L20C | 20 | | 292 | 205.9 | 243.9 | 246 | 291 | 1.9 | 12 | ● | 2 | |
| MPS1-1020-L25C | 25 | | 344 | 256.9 | 295.9 | 298 | 343 | 1.9 | 12 | □ | 2 | |

MPS1

VOLLHARTMETALLBOHRER

| Bestellnummer | DC | (l/d) | OAL | LU | LCF | LH | LF | PL | DCON | DP1021 | Typ |
|------------------|------|-------|-----|-------|-------|-----|-------|-------|------|--------|-----|
| MPS1-1030S-DIN | 10.3 | 3 | 102 | 39.4 | 55 | 57 | 100.1 | 1.9 | 12 | □ | 4 |
| MPS1-1030S-DIN-C | | 3 | 102 | 39.4 | 55 | 57 | 100.1 | 1.9 | 12 | ● | 2 |
| MPS1-1030L-DIN | | 5 | 118 | 55.4 | 71 | 73 | 116.1 | 1.9 | 12 | □ | 4 |
| MPS1-1030L-DIN-C | | 5 | 118 | 55.4 | 71 | 73 | 116.1 | 1.9 | 12 | ● | 2 |
| MPS1-1030-PC | | 2 | 96 | 22.2 | 44.6 | 47 | 95 | 1.6 | 12 | ● | 2 |
| MPS1-1030-L8C | | 8 | 167 | 84.5 | 118 | 121 | 165 | 1.9 | 12 | ● | 2 |
| MPS1-1030-L10C | | 10 | 187 | 104.9 | 138.9 | 141 | 186 | 1.9 | 12 | □ | 2 |
| MPS1-1030-L12C | | 12 | 208 | 125.5 | 159.9 | 162 | 207 | 1.9 | 12 | ● | 2 |
| MPS1-1030-L15C | | 15 | 239 | 156.4 | 190.9 | 193 | 238 | 1.9 | 12 | □ | 2 |
| MPS1-1030-L20C | | 20 | 292 | 207.9 | 243.9 | 246 | 291 | 1.9 | 12 | □ | 2 |
| MPS1-1030-L25C | | 25 | 344 | 259.4 | 295.9 | 298 | 343 | 1.9 | 12 | □ | 2 |
| MPS1-1040S-DIN | | 10.4 | 3 | 102 | 39.3 | 55 | 57 | 100.1 | 1.9 | 12 | □ |
| MPS1-1040S-DIN-C | 3 | | 102 | 39.3 | 55 | 57 | 100.1 | 1.9 | 12 | ● | 2 |
| MPS1-1040L-DIN | 5 | | 118 | 55.3 | 71 | 73 | 116.1 | 1.9 | 12 | □ | 4 |
| MPS1-1040L-DIN-C | 5 | | 118 | 55.3 | 71 | 73 | 116.1 | 1.9 | 12 | ● | 2 |
| MPS1-1040-PC | 2 | | 96 | 22.4 | 44.6 | 47 | 95 | 1.6 | 12 | ● | 2 |
| MPS1-1040-L8C | 8 | | 167 | 85.4 | 118 | 121 | 165 | 1.9 | 12 | ● | 2 |
| MPS1-1040-L10C | 10 | | 187 | 105.9 | 138.9 | 141 | 186 | 1.9 | 12 | □ | 2 |
| MPS1-1040-L12C | 12 | | 208 | 126.7 | 159.9 | 162 | 207 | 1.9 | 12 | ● | 2 |
| MPS1-1040-L15C | 15 | | 239 | 157.9 | 190.9 | 193 | 238 | 1.9 | 12 | □ | 2 |
| MPS1-1040-L20C | 20 | | 292 | 209.9 | 243.9 | 246 | 291 | 1.9 | 12 | □ | 2 |
| MPS1-1040-L25C | 25 | | 344 | 261.9 | 295.9 | 298 | 343 | 1.9 | 12 | □ | 2 |
| MPS1-1050S-DIN | 10.5 | | 3 | 102 | 39.2 | 55 | 57 | 100.1 | 1.9 | 12 | □ |
| MPS1-1050S-DIN-C | | 3 | 102 | 39.2 | 55 | 57 | 100.1 | 1.9 | 12 | ● | 2 |
| MPS1-1050L-DIN | | 5 | 118 | 55.2 | 71 | 73 | 116.1 | 1.9 | 12 | □ | 4 |
| MPS1-1050L-DIN-C | | 5 | 118 | 55.2 | 71 | 73 | 116.1 | 1.9 | 12 | ● | 2 |
| MPS1-1050-PC | | 2 | 96 | 22.7 | 44.7 | 47 | 95 | 1.7 | 12 | ● | 2 |
| MPS1-1050-L8C | | 8 | 167 | 86.2 | 118 | 121 | 165 | 1.9 | 12 | ● | 2 |
| MPS1-1050-L10C | | 10 | 187 | 106.9 | 138.9 | 141 | 186 | 1.9 | 12 | □ | 2 |
| MPS1-1050-L12C | | 12 | 208 | 127.9 | 159.9 | 162 | 207 | 1.9 | 12 | ● | 2 |
| MPS1-1050-L15C | | 15 | 239 | 159.4 | 190.9 | 193 | 238 | 1.9 | 12 | ● | 2 |
| MPS1-1050-L20C | | 20 | 292 | 211.9 | 243.9 | 246 | 291 | 1.9 | 12 | ● | 2 |
| MPS1-1050-L25C | | 25 | 344 | 264.4 | 295.9 | 298 | 343 | 1.9 | 12 | ● | 2 |
| MPS1-1060S-DIN | | 10.6 | 3 | 102 | 39.0 | 55 | 57 | 100.1 | 1.9 | 12 | □ |
| MPS1-1060S-DIN-C | 3 | | 102 | 39.0 | 55 | 57 | 100.1 | 1.9 | 12 | ● | 2 |
| MPS1-1060L-DIN | 5 | | 118 | 55.0 | 71 | 73 | 116.1 | 1.9 | 12 | □ | 4 |
| MPS1-1060L-DIN-C | 5 | | 118 | 55.0 | 71 | 73 | 116.1 | 1.9 | 12 | ● | 2 |
| MPS1-1060-PC | 2 | | 96 | 22.9 | 48.7 | 49 | 95 | 1.7 | 12 | □ | 2 |
| MPS1-1060-L8C | 8 | | 172 | 87.0 | 123 | 126 | 170 | 1.9 | 12 | ● | 2 |
| MPS1-1060-L10C | 10 | | 193 | 107.9 | 144.9 | 147 | 192 | 1.9 | 12 | □ | 2 |
| MPS1-1060-L12C | 12 | | 215 | 129.1 | 166.9 | 169 | 214 | 1.9 | 12 | □ | 2 |
| MPS1-1060-L15C | 15 | | 248 | 160.9 | 199.9 | 202 | 247 | 1.9 | 12 | □ | 2 |
| MPS1-1060-L20C | 20 | | 303 | 213.9 | 254.9 | 257 | 302 | 1.9 | 12 | □ | 2 |
| MPS1-1060-L25C | 25 | | 358 | 266.9 | 309.9 | 312 | 357 | 1.9 | 12 | □ | 2 |

MPS1

VOLLHARTMETALLBOHRER

| Bestellnummer | DC | (l/d) | OAL | LU | LCF | LH | LF | PL | DCON | DP1021 | Typ |
|------------------|------|-------|-----|-------|-------|-----|-------|-----|------|--------|-----|
| MPS1-1070S-DIN | 10.7 | 3 | 102 | 38.9 | 55 | 57 | 100.1 | 1.9 | 12 | □ | 4 |
| MPS1-1070S-DIN-C | | 3 | 102 | 38.9 | 55 | 57 | 100.1 | 1.9 | 12 | ● | 2 |
| MPS1-1070L-DIN | | 5 | 118 | 54.9 | 71 | 73 | 116.1 | 1.9 | 12 | □ | 4 |
| MPS1-1070L-DIN-C | | 5 | 118 | 54.9 | 71 | 73 | 116.1 | 1.9 | 12 | ● | 2 |
| MPS1-1070-PC | | 2 | 96 | 23.1 | 48.7 | 49 | 95 | 1.7 | 12 | ● | 2 |
| MPS1-1070-L8C | | 8 | 172 | 87.8 | 123 | 126 | 170 | 1.9 | 12 | ● | 2 |
| MPS1-1070-L10C | | 10 | 193 | 108.9 | 144.9 | 147 | 192 | 1.9 | 12 | □ | 2 |
| MPS1-1070-L12C | | 12 | 215 | 130.3 | 166.9 | 169 | 214 | 1.9 | 12 | ● | 2 |
| MPS1-1070-L15C | | 15 | 248 | 162.4 | 199.9 | 202 | 247 | 1.9 | 12 | □ | 2 |
| MPS1-1070-L20C | | 20 | 303 | 215.9 | 254.9 | 257 | 302 | 1.9 | 12 | □ | 2 |
| MPS1-1070-L25C | | 25 | 358 | 269.4 | 309.9 | 312 | 357 | 1.9 | 12 | □ | 2 |
| MPS1-1080S-DIN | 10.8 | 3 | 102 | 38.8 | 55 | 57 | 100 | 2.0 | 12 | □ | 4 |
| MPS1-1080S-DIN-C | | 3 | 102 | 38.8 | 55 | 57 | 100 | 2.0 | 12 | ● | 2 |
| MPS1-1080L-DIN | | 5 | 118 | 54.8 | 71 | 73 | 116 | 2.0 | 12 | □ | 4 |
| MPS1-1080L-DIN-C | | 5 | 118 | 54.8 | 71 | 73 | 116 | 2.0 | 12 | ● | 2 |
| MPS1-1080-PC | | 2 | 96 | 23.3 | 48.7 | 49 | 95 | 1.7 | 12 | ● | 2 |
| MPS1-1080-L8C | | 8 | 172 | 88.6 | 123 | 126 | 170 | 2.0 | 12 | ● | 2 |
| MPS1-1080-L10C | | 10 | 193 | 110 | 145 | 147 | 192 | 2.0 | 12 | □ | 2 |
| MPS1-1080-L12C | | 12 | 215 | 131.6 | 167 | 169 | 214 | 2.0 | 12 | ● | 2 |
| MPS1-1080-L15C | | 15 | 248 | 164 | 200 | 202 | 247 | 2.0 | 12 | □ | 2 |
| MPS1-1080-L20C | | 20 | 303 | 218 | 255 | 257 | 302 | 2.0 | 12 | □ | 2 |
| MPS1-1080-L25C | | 25 | 358 | 272 | 310 | 312 | 357 | 2.0 | 12 | □ | 2 |
| MPS1-1090S-DIN | 10.9 | 3 | 102 | 38.6 | 55 | 57 | 100 | 2.0 | 12 | □ | 4 |
| MPS1-1090S-DIN-C | | 3 | 102 | 38.6 | 55 | 57 | 100 | 2.0 | 12 | ● | 2 |
| MPS1-1090L-DIN | | 5 | 118 | 54.6 | 71 | 73 | 116 | 2.0 | 12 | □ | 4 |
| MPS1-1090L-DIN-C | | 5 | 118 | 54.6 | 71 | 73 | 116 | 2.0 | 12 | ● | 2 |
| MPS1-1090-PC | | 2 | 96 | 23.5 | 48.7 | 49 | 95 | 1.7 | 12 | □ | 2 |
| MPS1-1090-L8C | | 8 | 172 | 89.5 | 123 | 126 | 170 | 2.0 | 12 | ● | 2 |
| MPS1-1090-L10C | | 10 | 193 | 111 | 145 | 147 | 192 | 2.0 | 12 | □ | 2 |
| MPS1-1090-L12C | | 12 | 215 | 132.8 | 167 | 169 | 214 | 2.0 | 12 | □ | 2 |
| MPS1-1090-L15C | | 15 | 248 | 165.5 | 200 | 202 | 247 | 2.0 | 12 | □ | 2 |
| MPS1-1090-L20C | | 20 | 303 | 220 | 255 | 257 | 302 | 2.0 | 12 | □ | 2 |
| MPS1-1090-L25C | | 25 | 358 | 274.5 | 310 | 312 | 357 | 2.0 | 12 | □ | 2 |
| MPS1-1100S-DIN | 11 | 3 | 102 | 38.5 | 55 | 57 | 100 | 2.0 | 12 | □ | 4 |
| MPS1-1100S-DIN-C | | 3 | 102 | 38.5 | 55 | 57 | 100 | 2.0 | 12 | ● | 2 |
| MPS1-1100L-DIN | | 5 | 118 | 54.5 | 71 | 73 | 116 | 2.0 | 12 | □ | 4 |
| MPS1-1100L-DIN-C | | 5 | 118 | 54.5 | 71 | 73 | 116 | 2.0 | 12 | ● | 2 |
| MPS1-1100-PC | | 2 | 96 | 23.7 | 48.7 | 49 | 95 | 1.7 | 12 | ● | 2 |
| MPS1-1100-L8C | | 8 | 172 | 90.3 | 123 | 126 | 170 | 2.0 | 12 | ● | 2 |
| MPS1-1100-L10C | | 10 | 194 | 112 | 145 | 148 | 192 | 2.0 | 12 | □ | 2 |
| MPS1-1100-L12C | | 12 | 216 | 134 | 167 | 170 | 214 | 2.0 | 12 | ● | 2 |
| MPS1-1100-L15C | | 15 | 249 | 167 | 200 | 203 | 247 | 2.0 | 12 | ● | 2 |
| MPS1-1100-L20C | | 20 | 304 | 222 | 255 | 258 | 302 | 2.0 | 12 | ● | 2 |
| MPS1-1100-L25C | | 25 | 359 | 277 | 310 | 313 | 357 | 2.0 | 12 | ● | 2 |

MPS1

VOLLHARTMETALLBOHRER

| Bestellnummer | DC | (l/d) | OAL | LU | LCF | LH | LF | PL | DCON | DP1021 | Typ |
|------------------|------|-------|-----|-------|-------|-----|-------|-----|------|--------|-----|
| MPS1-1110S-DIN | | 3 | 102 | 38.4 | 55 | 57 | 100 | 2.0 | 12 | □ | 4 |
| MPS1-1110S-DIN-C | | 3 | 102 | 38.4 | 55 | 57 | 100 | 2.0 | 12 | ● | 2 |
| MPS1-1110L-DIN | | 5 | 118 | 54.4 | 71 | 73 | 116 | 2.0 | 12 | □ | 4 |
| MPS1-1110L-DIN-C | | 5 | 118 | 54.4 | 71 | 73 | 116 | 2.0 | 12 | ● | 2 |
| MPS1-1110-PC | | 2 | 96 | 23.9 | 48.7 | 51 | 95 | 1.7 | 12 | ● | 2 |
| MPS1-1110-L8C | 11.1 | 8 | 178 | 91.1 | 129 | 132 | 176 | 2.0 | 12 | ● | 2 |
| MPS1-1110-L10C | | 10 | 201 | 113 | 152 | 155 | 199 | 2.0 | 12 | □ | 2 |
| MPS1-1110-L12C | | 12 | 224 | 135.2 | 175 | 178 | 222 | 2.0 | 12 | ● | 2 |
| MPS1-1110-L15C | | 15 | 258 | 168.5 | 209 | 212 | 256 | 2.0 | 12 | ● | 2 |
| MPS1-1110-L20C | | 20 | 316 | 224 | 267 | 270 | 314 | 2.0 | 12 | □ | 2 |
| MPS1-1110-L25C | | 25 | 373 | 279.5 | 324 | 327 | 371 | 2.0 | 12 | ● | 2 |
| MPS1-1120S-DIN | | 3 | 102 | 38.2 | 55 | 57 | 100 | 2.0 | 12 | □ | 4 |
| MPS1-1120S-DIN-C | | 3 | 102 | 38.2 | 55 | 57 | 100 | 2.0 | 12 | ● | 2 |
| MPS1-1120L-DIN | | 5 | 118 | 54.2 | 71 | 73 | 116 | 2.0 | 12 | □ | 4 |
| MPS1-1120L-DIN-C | | 5 | 118 | 54.2 | 71 | 73 | 116 | 2.0 | 12 | ● | 2 |
| MPS1-1120-PC | | 2 | 96 | 24.2 | 48.8 | 51 | 95 | 1.8 | 12 | ● | 2 |
| MPS1-1120-L8C | 11.2 | 8 | 178 | 91.9 | 129 | 132 | 176 | 2.0 | 12 | ● | 2 |
| MPS1-1120-L10C | | 10 | 201 | 114 | 152 | 155 | 199 | 2.0 | 12 | □ | 2 |
| MPS1-1120-L12C | | 12 | 224 | 136.4 | 175 | 178 | 222 | 2.0 | 12 | □ | 2 |
| MPS1-1120-L15C | | 15 | 258 | 170 | 209 | 212 | 256 | 2.0 | 12 | ● | 2 |
| MPS1-1120-L20C | | 20 | 316 | 226 | 267 | 270 | 314 | 2.0 | 12 | □ | 2 |
| MPS1-1120-L25C | | 25 | 373 | 282 | 324 | 327 | 371 | 2.0 | 12 | □ | 2 |
| MPS1-1130S-DIN | | 3 | 102 | 38.1 | 55 | 57 | 99.9 | 2.1 | 12 | □ | 4 |
| MPS1-1130S-DIN-C | | 3 | 102 | 38.1 | 55 | 57 | 99.9 | 2.1 | 12 | ● | 2 |
| MPS1-1130L-DIN | | 5 | 118 | 54.1 | 71 | 73 | 115.9 | 2.1 | 12 | □ | 4 |
| MPS1-1130L-DIN-C | | 5 | 118 | 54.1 | 71 | 73 | 115.9 | 2.1 | 12 | ● | 2 |
| MPS1-1130-PC | | 2 | 96 | 24.4 | 48.8 | 51 | 95 | 1.8 | 12 | □ | 2 |
| MPS1-1130-L8C | 11.3 | 8 | 178 | 92.7 | 129 | 132 | 176 | 2.1 | 12 | ● | 2 |
| MPS1-1130-L10C | | 10 | 201 | 115.1 | 152.1 | 155 | 199 | 2.1 | 12 | □ | 2 |
| MPS1-1130-L12C | | 12 | 224 | 137.7 | 175.1 | 178 | 222 | 2.1 | 12 | □ | 2 |
| MPS1-1130-L15C | | 15 | 258 | 171.6 | 209.1 | 212 | 256 | 2.1 | 12 | □ | 2 |
| MPS1-1130-L20C | | 20 | 316 | 228.1 | 267.1 | 270 | 314 | 2.1 | 12 | □ | 2 |
| MPS1-1130-L25C | | 25 | 373 | 284.6 | 324.1 | 327 | 371 | 2.1 | 12 | □ | 2 |
| MPS1-1140S-DIN | | 3 | 102 | 38.0 | 55 | 57 | 99.9 | 2.1 | 12 | □ | 4 |
| MPS1-1140S-DIN-C | | 3 | 102 | 38.0 | 55 | 57 | 99.9 | 2.1 | 12 | ● | 2 |
| MPS1-1140L-DIN | | 5 | 118 | 54.0 | 71 | 73 | 115.9 | 2.1 | 12 | □ | 4 |
| MPS1-1140L-DIN-C | | 5 | 118 | 54.0 | 71 | 73 | 115.9 | 2.1 | 12 | ● | 2 |
| MPS1-1140-PC | | 2 | 96 | 24.6 | 48.8 | 51 | 95 | 1.8 | 12 | □ | 2 |
| MPS1-1140-L8C | 11.4 | 8 | 178 | 93.6 | 129 | 132 | 176 | 2.1 | 12 | ● | 2 |
| MPS1-1140-L10C | | 10 | 201 | 116.1 | 152.1 | 155 | 199 | 2.1 | 12 | □ | 2 |
| MPS1-1140-L12C | | 12 | 224 | 138.9 | 175.1 | 178 | 222 | 2.1 | 12 | □ | 2 |
| MPS1-1140-L15C | | 15 | 258 | 173.1 | 209.1 | 212 | 256 | 2.1 | 12 | □ | 2 |
| MPS1-1140-L20C | | 20 | 316 | 230.1 | 267.1 | 270 | 314 | 2.1 | 12 | □ | 2 |
| MPS1-1140-L25C | | 25 | 373 | 287.1 | 324.1 | 327 | 371 | 2.1 | 12 | □ | 2 |

MPS1

VOLLHARTMETALLBOHRER

| Bestellnummer | DC | (l/d) | OAL | LU | LCF | LH | LF | PL | DCON | DP1021 | Typ |
|------------------|------|-------|-------|-------|-------|-----|-------|-----|------|--------|-----|
| MPS1-1150S-DIN | 11.5 | 3 | 102 | 37.8 | 55 | 57 | 99.9 | 2.1 | 12 | □ | 4 |
| MPS1-1150S-DIN-C | | 3 | 102 | 37.8 | 55 | 57 | 99.9 | 2.1 | 12 | ● | 2 |
| MPS1-1150L-DIN | | 5 | 118 | 53.8 | 71 | 73 | 115.9 | 2.1 | 12 | □ | 4 |
| MPS1-1150L-DIN-C | | 5 | 118 | 53.8 | 71 | 73 | 115.9 | 2.1 | 12 | ● | 2 |
| MPS1-1150-PC | | 2 | 96 | 24.8 | 48.8 | 51 | 95 | 1.8 | 12 | ● | 2 |
| MPS1-1150-L8C | | 8 | 178 | 94.4 | 129 | 132 | 176 | 2.1 | 12 | ● | 2 |
| MPS1-1150-L10C | | 10 | 201 | 117.1 | 152.1 | 155 | 199 | 2.1 | 12 | □ | 2 |
| MPS1-1150-L12C | | 12 | 224 | 140.1 | 175.1 | 178 | 222 | 2.1 | 12 | ● | 2 |
| MPS1-1150-L15C | | 15 | 258 | 174.6 | 209.1 | 212 | 256 | 2.1 | 12 | ● | 2 |
| MPS1-1150-L20C | | 20 | 316 | 232.1 | 267.1 | 270 | 314 | 2.1 | 12 | ● | 2 |
| MPS1-1150-L25C | 25 | 373 | 289.6 | 324.1 | 327 | 371 | 2.1 | 12 | ● | 2 | |
| MPS1-1160S-DIN | 11.6 | 3 | 102 | 37.7 | 55 | 57 | 99.9 | 2.1 | 12 | □ | 4 |
| MPS1-1160S-DIN-C | | 3 | 102 | 37.7 | 55 | 57 | 99.9 | 2.1 | 12 | ● | 2 |
| MPS1-1160L-DIN | | 5 | 118 | 53.7 | 71 | 73 | 115.9 | 2.1 | 12 | □ | 4 |
| MPS1-1160L-DIN-C | | 5 | 118 | 53.7 | 71 | 73 | 115.9 | 2.1 | 12 | ● | 2 |
| MPS1-1160-PC | | 2 | 96 | 25 | 48.8 | 48 | 95 | 1.8 | 12 | □ | 2 |
| MPS1-1160-L8C | | 8 | 183 | 95.2 | 134 | 137 | 181 | 2.1 | 12 | ● | 2 |
| MPS1-1160-L10C | | 10 | 207 | 118.1 | 158.1 | 161 | 205 | 2.1 | 12 | □ | 2 |
| MPS1-1160-L12C | | 12 | 231 | 141.3 | 182.1 | 185 | 229 | 2.1 | 12 | □ | 2 |
| MPS1-1160-L15C | | 15 | 267 | 176.1 | 218.1 | 221 | 265 | 2.1 | 12 | □ | 2 |
| MPS1-1160-L20C | | 20 | 327 | 234.1 | 278.1 | 281 | 325 | 2.1 | 12 | □ | 2 |
| MPS1-1160-L25C | 25 | 387 | 292.1 | 338.1 | 341 | 385 | 2.1 | 12 | □ | 2 | |
| MPS1-1170S-DIN | 11.7 | 3 | 102 | 37.6 | 55 | 57 | 99.9 | 2.1 | 12 | □ | 4 |
| MPS1-1170S-DIN-C | | 3 | 102 | 37.6 | 55 | 57 | 99.9 | 2.1 | 12 | ● | 2 |
| MPS1-1170L-DIN | | 5 | 118 | 53.6 | 71 | 73 | 115.9 | 2.1 | 12 | □ | 4 |
| MPS1-1170L-DIN-C | | 5 | 118 | 53.6 | 71 | 73 | 115.9 | 2.1 | 12 | ● | 2 |
| MPS1-1170-PC | | 2 | 96 | 25.2 | 48.8 | 48 | 95 | 1.8 | 12 | ● | 2 |
| MPS1-1170-L8C | | 8 | 183 | 96.0 | 134 | 137 | 181 | 2.1 | 12 | ● | 2 |
| MPS1-1170-L10C | | 10 | 207 | 119.1 | 158.1 | 161 | 205 | 2.1 | 12 | □ | 2 |
| MPS1-1170-L12C | | 12 | 231 | 142.5 | 182.1 | 185 | 229 | 2.1 | 12 | ● | 2 |
| MPS1-1170-L15C | | 15 | 267 | 177.6 | 218.1 | 221 | 265 | 2.1 | 12 | ● | 2 |
| MPS1-1170-L20C | | 20 | 327 | 236.1 | 278.1 | 281 | 325 | 2.1 | 12 | □ | 2 |
| MPS1-1170-L25C | 25 | 387 | 294.6 | 338.1 | 341 | 385 | 2.1 | 12 | □ | 2 | |
| MPS1-1180S-DIN | 11.8 | 3 | 102 | 37.4 | 55 | 57 | 99.9 | 2.1 | 12 | □ | 4 |
| MPS1-1180S-DIN-C | | 3 | 102 | 37.4 | 55 | 57 | 99.9 | 2.1 | 12 | ● | 2 |
| MPS1-1180L-DIN | | 5 | 118 | 53.4 | 71 | 73 | 115.9 | 2.1 | 12 | □ | 4 |
| MPS1-1180L-DIN-C | | 5 | 118 | 53.4 | 71 | 73 | 115.9 | 2.1 | 12 | ● | 2 |
| MPS1-1180-PC | | 2 | 96 | 25.5 | 48.9 | 48 | 95 | 1.9 | 12 | ● | 2 |
| MPS1-1180-L8C | | 8 | 183 | 96.8 | 134 | 137 | 181 | 2.1 | 12 | ● | 2 |
| MPS1-1180-L10C | | 10 | 207 | 120.1 | 158.1 | 161 | 205 | 2.1 | 12 | □ | 2 |
| MPS1-1180-L12C | | 12 | 231 | 143.7 | 182.1 | 185 | 229 | 2.1 | 12 | ● | 2 |
| MPS1-1180-L15C | | 15 | 267 | 179.1 | 218.1 | 221 | 265 | 2.1 | 12 | ● | 2 |
| MPS1-1180-L20C | | 20 | 327 | 238.1 | 278.1 | 281 | 325 | 2.1 | 12 | □ | 2 |
| MPS1-1180-L25C | 25 | 387 | 297.1 | 338.1 | 341 | 385 | 2.1 | 12 | □ | 2 | |

MPS1

VOLLHARTMETALLBOHRER

| Bestellnummer | DC | (l/d) | OAL | LU | LCF | LH | LF | PL | DCON | DP1021 | Typ |
|------------------|-------|-------|-----|-------|-------|-----|-------|-------|------|--------|-----|
| MPS1-1190S-DIN | 11.9 | 3 | 102 | 37.3 | 55 | 57 | 99.8 | 2.2 | 12 | □ | 4 |
| MPS1-1190S-DIN-C | | 3 | 102 | 37.3 | 55 | 57 | 99.8 | 2.2 | 12 | ● | 2 |
| MPS1-1190L-DIN | | 5 | 118 | 53.3 | 71 | 73 | 115.8 | 2.2 | 12 | □ | 4 |
| MPS1-1190L-DIN-C | | 5 | 118 | 53.3 | 71 | 73 | 115.8 | 2.2 | 12 | ● | 2 |
| MPS1-1190-PC | | 2 | 96 | 25.7 | 48.9 | 48 | 95 | 1.9 | 12 | □ | 2 |
| MPS1-1190-L8C | | 8 | 183 | 97.7 | 134 | 137 | 181 | 2.2 | 12 | ● | 2 |
| MPS1-1190-L10C | | 10 | 207 | 121.2 | 158.2 | 161 | 205 | 2.2 | 12 | □ | 2 |
| MPS1-1190-L12C | | 12 | 231 | 145 | 182.2 | 185 | 229 | 2.2 | 12 | □ | 2 |
| MPS1-1190-L15C | | 15 | 267 | 180.7 | 218.2 | 221 | 265 | 2.2 | 12 | □ | 2 |
| MPS1-1190-L20C | | 20 | 327 | 240.2 | 278.2 | 281 | 325 | 2.2 | 12 | □ | 2 |
| MPS1-1190-L25C | | 25 | 387 | 299.7 | 338.2 | 341 | 385 | 2.2 | 12 | □ | 2 |
| MPS1-1200S-DIN | 12 | 3 | 102 | 37.2 | 55 | 57 | 99.8 | 2.2 | 12 | □ | 4 |
| MPS1-1200S-DIN-C | | 3 | 102 | 37.2 | 55 | 57 | 99.8 | 2.2 | 12 | ● | 2 |
| MPS1-1200L-DIN | | 5 | 118 | 53.2 | 71 | 73 | 115.8 | 2.2 | 12 | □ | 4 |
| MPS1-1200L-DIN-C | | 5 | 118 | 53.2 | 71 | 73 | 115.8 | 2.2 | 12 | ● | 2 |
| MPS1-1200-PC | | 2 | 96 | 25.9 | 48.9 | 48 | 95 | 1.9 | 12 | ● | 2 |
| MPS1-1200-L8C | | 8 | 183 | 98.5 | 134 | 137 | 181 | 2.2 | 12 | ● | 2 |
| MPS1-1200-L10C | | 10 | 207 | 122.2 | 158.2 | 161 | 205 | 2.2 | 12 | □ | 2 |
| MPS1-1200-L12C | | 12 | 231 | 146.2 | 182.2 | 185 | 229 | 2.2 | 12 | ● | 2 |
| MPS1-1200-L15C | | 15 | 267 | 182.2 | 218.2 | 221 | 265 | 2.2 | 12 | ● | 2 |
| MPS1-1200-L20C | | 20 | 327 | 242.2 | 278.2 | 281 | 325 | 2.2 | 12 | ● | 2 |
| MPS1-1200-L25C | | 25 | 387 | 302.2 | 338.2 | 341 | 385 | 2.2 | 12 | ● | 2 |
| MPS1-1205S-DIN | 12.05 | 3 | 107 | 42.1 | 60 | 62 | 104.8 | 2.2 | 14 | □ | 4 |
| MPS1-1205S-DIN-C | | 3 | 107 | 42.1 | 60 | 62 | 104.8 | 2.2 | 14 | ● | 2 |
| MPS1-1205L-DIN | | 5 | 124 | 59.1 | 77 | 79 | 121.8 | 2.2 | 14 | □ | 4 |
| MPS1-1205L-DIN-C | | 5 | 124 | 59.1 | 77 | 79 | 121.8 | 2.2 | 14 | ● | 2 |
| MPS1-1210S-DIN | | 12.1 | 3 | 107 | 42.1 | 60 | 62 | 104.8 | 2.2 | 14 | □ |
| MPS1-1210S-DIN-C | 3 | | 107 | 42.1 | 60 | 62 | 104.8 | 2.2 | 14 | ● | 2 |
| MPS1-1210L-DIN | 5 | | 124 | 59.1 | 77 | 79 | 121.8 | 2.2 | 14 | □ | 4 |
| MPS1-1210L-DIN-C | 5 | | 124 | 59.1 | 77 | 79 | 121.8 | 2.2 | 14 | ● | 2 |
| MPS1-1210-PC | 2 | | 103 | 26.1 | 52.9 | 55 | 102 | 1.9 | 14 | ● | 2 |
| MPS1-1210-L8C | 8 | | 190 | 99.3 | 140 | 144 | 187 | 2.2 | 14 | ● | 2 |
| MPS1-1210-L10C | 10 | | 214 | 123.2 | 165.2 | 168 | 212 | 2.2 | 14 | □ | 2 |
| MPS1-1210-L12C | 12 | | 239 | 147.4 | 190.2 | 193 | 237 | 2.2 | 14 | ● | 2 |
| MPS1-1210-L15C | 15 | | 276 | 183.7 | 227.2 | 230 | 274 | 2.2 | 14 | ● | 2 |
| MPS1-1210-L20C | 20 | | 339 | 244.2 | 290.2 | 293 | 337 | 2.2 | 14 | □ | 2 |
| MPS1-1220S-DIN | 12.2 | | 3 | 107 | 41.9 | 60 | 62 | 104.8 | 2.2 | 14 | □ |
| MPS1-1220S-DIN-C | | 3 | 107 | 41.9 | 60 | 62 | 104.8 | 2.2 | 14 | ● | 2 |
| MPS1-1220L-DIN | | 5 | 124 | 58.9 | 77 | 79 | 121.8 | 2.2 | 14 | □ | 4 |
| MPS1-1220L-DIN-C | | 5 | 124 | 58.9 | 77 | 79 | 121.8 | 2.2 | 14 | ● | 2 |
| MPS1-1220-PC | | 2 | 103 | 26.3 | 52.9 | 55 | 102 | 1.9 | 14 | ● | 2 |
| MPS1-1220-L8C | | 8 | 190 | 100.1 | 140 | 144 | 187 | 2.2 | 14 | ● | 2 |
| MPS1-1220-L10C | | 10 | 214 | 124.2 | 165.2 | 168 | 212 | 2.2 | 14 | □ | 2 |
| MPS1-1220-L12C | | 12 | 239 | 148.6 | 190.2 | 193 | 237 | 2.2 | 14 | ● | 2 |
| MPS1-1220-L15C | | 15 | 276 | 185.2 | 227.2 | 230 | 274 | 2.2 | 14 | ● | 2 |
| MPS1-1220-L20C | | 20 | 339 | 246.2 | 290.2 | 293 | 337 | 2.2 | 14 | □ | 2 |

MPS1

VOLLHARTMETALLBOHRER

| Bestellnummer | DC | (l/d) | OAL | LU | LCF | LH | LF | PL | DCON | DP1021 | Typ |
|------------------|------|-------|-----|-------|-------|-----|-------|-----|------|--------|-----|
| MPS1-1230S-DIN | 12.3 | 3 | 107 | 41.8 | 60 | 62 | 104.8 | 2.2 | 14 | □ | 4 |
| MPS1-1230S-DIN-C | | 3 | 107 | 41.8 | 60 | 62 | 104.8 | 2.2 | 14 | ● | 2 |
| MPS1-1230L-DIN | | 5 | 124 | 58.8 | 77 | 79 | 121.8 | 2.2 | 14 | □ | 4 |
| MPS1-1230L-DIN-C | | 5 | 124 | 58.8 | 77 | 79 | 121.8 | 2.2 | 14 | ● | 2 |
| MPS1-1230-PC | | 2 | 103 | 26.5 | 52.9 | 55 | 102 | 1.9 | 14 | □ | 2 |
| MPS1-1230-L8C | | 8 | 190 | 100.9 | 140 | 144 | 187 | 2.2 | 14 | ● | 2 |
| MPS1-1230-L10C | | 10 | 214 | 125.2 | 165.2 | 168 | 212 | 2.2 | 14 | □ | 2 |
| MPS1-1230-L12C | | 12 | 239 | 149.8 | 190.2 | 193 | 237 | 2.2 | 14 | □ | 2 |
| MPS1-1230-L15C | | 15 | 276 | 186.7 | 227.2 | 230 | 274 | 2.2 | 14 | □ | 2 |
| MPS1-1230-L20C | | 20 | 339 | 248.2 | 290.2 | 293 | 337 | 2.2 | 14 | □ | 2 |
| MPS1-1240S-DIN | 12.4 | 3 | 107 | 41.7 | 60 | 62 | 104.7 | 2.3 | 14 | □ | 4 |
| MPS1-1240S-DIN-C | | 3 | 107 | 41.7 | 60 | 62 | 104.7 | 2.3 | 14 | ● | 2 |
| MPS1-1240L-DIN | | 5 | 124 | 58.7 | 77 | 79 | 121.7 | 2.3 | 14 | □ | 4 |
| MPS1-1240L-DIN-C | | 5 | 124 | 58.7 | 77 | 79 | 121.7 | 2.3 | 14 | ● | 2 |
| MPS1-1240-PC | | 2 | 103 | 26.8 | 53 | 55 | 102 | 2.0 | 14 | □ | 2 |
| MPS1-1240-L8C | | 8 | 190 | 101.8 | 140 | 144 | 187 | 2.3 | 14 | ● | 2 |
| MPS1-1240-L10C | | 10 | 214 | 126.3 | 165.3 | 168 | 212 | 2.3 | 14 | □ | 2 |
| MPS1-1240-L12C | | 12 | 239 | 151.1 | 190.3 | 193 | 237 | 2.3 | 14 | □ | 2 |
| MPS1-1240-L15C | | 15 | 276 | 188.3 | 227.3 | 230 | 274 | 2.3 | 14 | □ | 2 |
| MPS1-1240-L20C | | 20 | 339 | 250.3 | 290.3 | 293 | 337 | 2.3 | 14 | □ | 2 |
| MPS1-1250S-DIN | 12.5 | 3 | 107 | 41.5 | 60 | 62 | 104.7 | 2.3 | 14 | □ | 4 |
| MPS1-1250S-DIN-C | | 3 | 107 | 41.5 | 60 | 62 | 104.7 | 2.3 | 14 | ● | 2 |
| MPS1-1250L-DIN | | 5 | 124 | 58.5 | 77 | 79 | 121.7 | 2.3 | 14 | □ | 4 |
| MPS1-1250L-DIN-C | | 5 | 124 | 58.5 | 77 | 79 | 121.7 | 2.3 | 14 | ● | 2 |
| MPS1-1250-PC | | 2 | 103 | 27 | 53 | 55 | 102 | 2.0 | 14 | ● | 2 |
| MPS1-1250-L8C | | 8 | 190 | 102.6 | 140 | 144 | 187 | 2.3 | 14 | ● | 2 |
| MPS1-1250-L10C | | 10 | 214 | 127.3 | 165.3 | 168 | 212 | 2.3 | 14 | □ | 2 |
| MPS1-1250-L12C | | 12 | 239 | 152.3 | 190.3 | 193 | 237 | 2.3 | 14 | ● | 2 |
| MPS1-1250-L15C | | 15 | 276 | 189.8 | 227.3 | 230 | 274 | 2.3 | 14 | ● | 2 |
| MPS1-1250-L20C | | 20 | 339 | 252.3 | 290.3 | 293 | 337 | 2.3 | 14 | □ | 2 |
| MPS1-1260S-DIN | 12.6 | 3 | 107 | 41.4 | 60 | 62 | 104.7 | 2.3 | 14 | □ | 4 |
| MPS1-1260S-DIN-C | | 3 | 107 | 41.4 | 60 | 62 | 104.7 | 2.3 | 14 | ● | 2 |
| MPS1-1260L-DIN | | 5 | 124 | 58.4 | 77 | 79 | 121.7 | 2.3 | 14 | □ | 4 |
| MPS1-1260L-DIN-C | | 5 | 124 | 58.4 | 77 | 79 | 121.7 | 2.3 | 14 | ● | 2 |
| MPS1-1260-PC | | 2 | 103 | 27.2 | 53 | 54 | 102 | 2.0 | 14 | □ | 2 |
| MPS1-1260-L8C | | 8 | 195 | 103.4 | 145 | 149 | 192 | 2.3 | 14 | ● | 2 |
| MPS1-1260-L10C | | 10 | 220 | 128.3 | 171.3 | 174 | 218 | 2.3 | 14 | □ | 2 |
| MPS1-1260-L12C | | 12 | 246 | 153.5 | 197.3 | 200 | 244 | 2.3 | 14 | □ | 2 |
| MPS1-1260-L15C | | 15 | 285 | 191.3 | 236.3 | 239 | 283 | 2.3 | 14 | □ | 2 |
| MPS1-1260-L20C | | 20 | 350 | 254.3 | 301.3 | 304 | 348 | 2.3 | 14 | □ | 2 |

MPS1

VOLLHARTMETALLBOHRER

| Bestellnummer | DC | (l/d) | OAL | LU | LCF | LH | LF | PL | DCON | DP1021 | Typ |
|------------------|------|-------|-----|-------|-------|-----|-------|-----|------|--------|-----|
| MPS1-1270S-DIN | 12.7 | 3 | 107 | 41.3 | 60 | 62 | 104.7 | 2.3 | 14 | □ | 4 |
| MPS1-1270S-DIN-C | | 3 | 107 | 41.3 | 60 | 62 | 104.7 | 2.3 | 14 | ● | 2 |
| MPS1-1270L-DIN | | 5 | 124 | 58.3 | 77 | 79 | 121.7 | 2.3 | 14 | □ | 4 |
| MPS1-1270L-DIN-C | | 5 | 124 | 58.3 | 77 | 79 | 121.7 | 2.3 | 14 | ● | 2 |
| MPS1-1270-PC | | 2 | 104 | 27.4 | 53 | 55 | 102 | 2.0 | 14 | ● | 2 |
| MPS1-1270-L8C | | 8 | 195 | 104.2 | 145 | 149 | 192 | 2.3 | 14 | ● | 2 |
| MPS1-1270-L10C | | 10 | 220 | 129.3 | 171.3 | 174 | 218 | 2.3 | 14 | □ | 2 |
| MPS1-1270-L12C | | 12 | 246 | 154.7 | 197.3 | 200 | 244 | 2.3 | 14 | ● | 2 |
| MPS1-1270-L15C | | 15 | 285 | 192.8 | 236.3 | 239 | 283 | 2.3 | 14 | □ | 2 |
| MPS1-1270-L20C | | 20 | 350 | 256.3 | 301.3 | 304 | 348 | 2.3 | 14 | □ | 2 |
| MPS1-1280S-DIN | 12.8 | 3 | 107 | 41.1 | 60 | 62 | 104.7 | 2.3 | 14 | □ | 4 |
| MPS1-1280S-DIN-C | | 3 | 107 | 41.1 | 60 | 62 | 104.7 | 2.3 | 14 | ● | 2 |
| MPS1-1280L-DIN | | 5 | 124 | 58.1 | 77 | 79 | 121.7 | 2.3 | 14 | □ | 4 |
| MPS1-1280L-DIN-C | | 5 | 124 | 58.1 | 77 | 79 | 121.7 | 2.3 | 14 | ● | 2 |
| MPS1-1280-PC | | 2 | 104 | 27.6 | 53 | 55 | 102 | 2.0 | 14 | ● | 2 |
| MPS1-1280-L8C | | 8 | 195 | 105.1 | 145 | 149 | 192 | 2.3 | 14 | ● | 2 |
| MPS1-1280-L10C | | 10 | 220 | 130.3 | 171.3 | 174 | 218 | 2.3 | 14 | □ | 2 |
| MPS1-1280-L12C | | 12 | 246 | 155.9 | 197.3 | 200 | 244 | 2.3 | 14 | ● | 2 |
| MPS1-1280-L15C | | 15 | 285 | 194.3 | 236.3 | 239 | 283 | 2.3 | 14 | □ | 2 |
| MPS1-1280-L20C | | 20 | 350 | 258.3 | 301.3 | 304 | 348 | 2.3 | 14 | □ | 2 |
| MPS1-1290S-DIN | 12.9 | 3 | 107 | 41.0 | 60 | 62 | 104.7 | 2.3 | 14 | □ | 4 |
| MPS1-1290S-DIN-C | | 3 | 107 | 41.0 | 60 | 62 | 104.7 | 2.3 | 14 | ● | 2 |
| MPS1-1290L-DIN | | 5 | 124 | 58.0 | 77 | 79 | 121.7 | 2.3 | 14 | □ | 4 |
| MPS1-1290L-DIN-C | | 5 | 124 | 58.0 | 77 | 79 | 121.7 | 2.3 | 14 | ● | 2 |
| MPS1-1290-PC | | 2 | 104 | 27.8 | 53 | 55 | 102 | 2.0 | 14 | □ | 2 |
| MPS1-1290-L8C | | 8 | 195 | 105.9 | 145 | 149 | 192 | 2.3 | 14 | ● | 2 |
| MPS1-1290-L10C | | 10 | 220 | 131.3 | 171.3 | 174 | 218 | 2.3 | 14 | □ | 2 |
| MPS1-1290-L12C | | 12 | 246 | 157.1 | 197.3 | 200 | 244 | 2.3 | 14 | □ | 2 |
| MPS1-1290-L15C | | 15 | 285 | 195.8 | 236.3 | 239 | 283 | 2.3 | 14 | □ | 2 |
| MPS1-1290-L20C | | 20 | 350 | 260.3 | 301.3 | 304 | 348 | 2.3 | 14 | □ | 2 |
| MPS1-1300S-DIN | 13 | 3 | 107 | 40.9 | 60 | 62 | 104.6 | 2.4 | 14 | □ | 4 |
| MPS1-1300S-DIN-C | | 3 | 107 | 40.9 | 60 | 62 | 104.6 | 2.4 | 14 | ● | 2 |
| MPS1-1300L-DIN | | 5 | 124 | 57.9 | 77 | 79 | 121.6 | 2.4 | 14 | □ | 4 |
| MPS1-1300L-DIN-C | | 5 | 124 | 57.9 | 77 | 79 | 121.6 | 2.4 | 14 | ● | 2 |
| MPS1-1300-PC | | 2 | 104 | 28 | 53 | 55 | 102 | 2.0 | 14 | ● | 2 |
| MPS1-1300-L8C | | 8 | 195 | 106.7 | 145 | 149 | 192 | 2.4 | 14 | ● | 2 |
| MPS1-1300-L10C | | 10 | 220 | 132.4 | 171.4 | 174 | 218 | 2.4 | 14 | □ | 2 |
| MPS1-1300-L12C | | 12 | 246 | 158.4 | 197.4 | 200 | 244 | 2.4 | 14 | ● | 2 |
| MPS1-1300-L15C | | 15 | 285 | 197.4 | 236.4 | 239 | 283 | 2.4 | 14 | ● | 2 |
| MPS1-1300-L20C | | 20 | 350 | 262.4 | 301.4 | 304 | 348 | 2.4 | 14 | ● | 2 |



MPS1

VOLLHARTMETALLBOHRER

| Bestellnummer | DC | (l/d) | OAL | LU | LCF | LH | LF | PL | DCON | DP1021 | Typ |
|------------------|------|-------|-----|-------|-------|-----|-------|-----|------|--------|-----|
| MPS1-1310S-DIN | 13.1 | 3 | 107 | 40.7 | 60 | 62 | 104.6 | 2.4 | 14 | □ | 4 |
| MPS1-1310S-DIN-C | | 3 | 107 | 40.7 | 60 | 62 | 104.6 | 2.4 | 14 | ● | 2 |
| MPS1-1310L-DIN | | 5 | 124 | 57.7 | 77 | 79 | 121.6 | 2.4 | 14 | □ | 4 |
| MPS1-1310L-DIN-C | | 5 | 124 | 57.7 | 77 | 79 | 121.6 | 2.4 | 14 | ● | 2 |
| MPS1-1310-PC | | 2 | 109 | 28.3 | 56.1 | 59 | 107 | 2.1 | 14 | □ | 2 |
| MPS1-1310-L8C | | 8 | 201 | 107.5 | 151 | 155 | 198 | 2.4 | 14 | ● | 2 |
| MPS1-1310-L10C | | 10 | 227 | 133.4 | 178.4 | 181 | 225 | 2.4 | 14 | □ | 2 |
| MPS1-1310-L12C | | 12 | 254 | 159.6 | 205.4 | 208 | 252 | 2.4 | 14 | □ | 2 |
| MPS1-1310-L15C | | 15 | 294 | 198.9 | 245.4 | 248 | 292 | 2.4 | 14 | □ | 2 |
| MPS1-1310-L20C | | 20 | 362 | 264.4 | 313.4 | 316 | 360 | 2.4 | 14 | □ | 2 |
| MPS1-1320S-DIN | 13.2 | 3 | 107 | 40.6 | 60 | 62 | 104.6 | 2.4 | 14 | □ | 4 |
| MPS1-1320S-DIN-C | | 3 | 107 | 40.6 | 60 | 62 | 104.6 | 2.4 | 14 | ● | 2 |
| MPS1-1320L-DIN | | 5 | 124 | 57.6 | 77 | 79 | 121.6 | 2.4 | 14 | □ | 4 |
| MPS1-1320L-DIN-C | | 5 | 124 | 57.6 | 77 | 79 | 121.6 | 2.4 | 14 | ● | 2 |
| MPS1-1320-PC | | 2 | 109 | 28.5 | 56.1 | 59 | 107 | 2.1 | 14 | ● | 2 |
| MPS1-1320-L8C | | 8 | 201 | 108.3 | 151 | 155 | 198 | 2.4 | 14 | ● | 2 |
| MPS1-1320-L10C | | 10 | 227 | 134.4 | 178.4 | 181 | 225 | 2.4 | 14 | □ | 2 |
| MPS1-1320-L12C | | 12 | 254 | 160.8 | 205.4 | 208 | 252 | 2.4 | 14 | ● | 2 |
| MPS1-1320-L15C | | 15 | 294 | 200.4 | 245.4 | 248 | 292 | 2.4 | 14 | □ | 2 |
| MPS1-1320-L20C | | 20 | 362 | 266.4 | 313.4 | 316 | 360 | 2.4 | 14 | □ | 2 |
| MPS1-1330S-DIN | 13.3 | 3 | 107 | 40.5 | 60 | 62 | 104.6 | 2.4 | 14 | □ | 4 |
| MPS1-1330S-DIN-C | | 3 | 107 | 40.5 | 60 | 62 | 104.6 | 2.4 | 14 | ● | 2 |
| MPS1-1330L-DIN | | 5 | 124 | 57.5 | 77 | 79 | 121.6 | 2.4 | 14 | □ | 4 |
| MPS1-1330L-DIN-C | | 5 | 124 | 57.5 | 77 | 79 | 121.6 | 2.4 | 14 | ● | 2 |
| MPS1-1330-PC | | 2 | 109 | 28.7 | 56.1 | 59 | 107 | 2.1 | 14 | □ | 2 |
| MPS1-1330-L8C | | 8 | 201 | 109.2 | 151 | 155 | 198 | 2.4 | 14 | ● | 2 |
| MPS1-1330-L10C | | 10 | 227 | 135.4 | 178.4 | 181 | 225 | 2.4 | 14 | □ | 2 |
| MPS1-1330-L12C | | 12 | 254 | 162 | 205.4 | 208 | 252 | 2.4 | 14 | □ | 2 |
| MPS1-1330-L15C | | 15 | 294 | 201.9 | 245.4 | 248 | 292 | 2.4 | 14 | □ | 2 |
| MPS1-1330-L20C | | 20 | 362 | 268.4 | 313.4 | 316 | 360 | 2.4 | 14 | □ | 2 |
| MPS1-1340S-DIN | 13.4 | 3 | 107 | 40.3 | 60 | 62 | 104.6 | 2.4 | 14 | □ | 4 |
| MPS1-1340S-DIN-C | | 3 | 107 | 40.3 | 60 | 62 | 104.6 | 2.4 | 14 | ● | 2 |
| MPS1-1340L-DIN | | 5 | 124 | 57.3 | 77 | 79 | 121.6 | 2.4 | 14 | □ | 4 |
| MPS1-1340L-DIN-C | | 5 | 124 | 57.3 | 77 | 79 | 121.6 | 2.4 | 14 | ● | 2 |
| MPS1-1340-PC | | 2 | 109 | 28.9 | 56.1 | 59 | 107 | 2.1 | 14 | □ | 2 |
| MPS1-1340-L8C | | 8 | 201 | 110.0 | 151 | 155 | 198 | 2.4 | 14 | ● | 2 |
| MPS1-1340-L10C | | 10 | 227 | 136.4 | 178.4 | 181 | 225 | 2.4 | 14 | □ | 2 |
| MPS1-1340-L12C | | 12 | 254 | 163.2 | 205.4 | 208 | 252 | 2.4 | 14 | □ | 2 |
| MPS1-1340-L15C | | 15 | 294 | 203.4 | 245.4 | 248 | 292 | 2.4 | 14 | □ | 2 |
| MPS1-1340-L20C | | 20 | 362 | 270.4 | 313.4 | 316 | 360 | 2.4 | 14 | □ | 2 |

MPS1

VOLLHARTMETALLBOHRER

| Bestellnummer | DC | (l/d) | OAL | LU | LCF | LH | LF | PL | DCON | DP1021 | Typ |
|------------------|------|-------|-----|-------|-------|-----|-------|-----|------|--------|-----|
| MPS1-1350S-DIN | 13.5 | 3 | 107 | 40.2 | 60 | 62 | 104.5 | 2.5 | 14 | □ | 4 |
| MPS1-1350S-DIN-C | | 3 | 107 | 40.2 | 60 | 62 | 104.5 | 2.5 | 14 | ● | 2 |
| MPS1-1350L-DIN | | 5 | 124 | 57.2 | 77 | 79 | 121.5 | 2.5 | 14 | □ | 4 |
| MPS1-1350L-DIN-C | | 5 | 124 | 57.2 | 77 | 79 | 121.5 | 2.5 | 14 | ● | 2 |
| MPS1-1350-PC | | 2 | 109 | 29.1 | 56.1 | 59 | 107 | 2.1 | 14 | ● | 2 |
| MPS1-1350-L8C | | 8 | 201 | 110.8 | 151 | 155 | 198 | 2.5 | 14 | ● | 2 |
| MPS1-1350-L10C | | 10 | 227 | 137.5 | 178.5 | 181 | 225 | 2.5 | 14 | □ | 2 |
| MPS1-1350-L12C | | 12 | 254 | 164.5 | 205.5 | 208 | 252 | 2.5 | 14 | ● | 2 |
| MPS1-1350-L15C | | 15 | 294 | 205 | 245.5 | 248 | 292 | 2.5 | 14 | □ | 2 |
| MPS1-1350-L20C | | 20 | 362 | 272.5 | 313.5 | 316 | 360 | 2.5 | 14 | □ | 2 |
| MPS1-1360S-DIN | 13.6 | 3 | 107 | 40.1 | 60 | 62 | 104.5 | 2.5 | 14 | □ | 4 |
| MPS1-1360S-DIN-C | | 3 | 107 | 40.1 | 60 | 62 | 104.5 | 2.5 | 14 | ● | 2 |
| MPS1-1360L-DIN | | 5 | 124 | 57.1 | 77 | 79 | 121.5 | 2.5 | 14 | □ | 4 |
| MPS1-1360L-DIN-C | | 5 | 124 | 57.1 | 77 | 79 | 121.5 | 2.5 | 14 | ● | 2 |
| MPS1-1360-PC | | 2 | 109 | 29.3 | 56.1 | 56 | 107 | 2.1 | 14 | □ | 2 |
| MPS1-1360-L8C | | 8 | 206 | 111.6 | 156 | 160 | 203 | 2.5 | 14 | ● | 2 |
| MPS1-1360-L10C | | 10 | 233 | 138.5 | 184.5 | 187 | 231 | 2.5 | 14 | □ | 2 |
| MPS1-1360-L12C | | 12 | 261 | 165.7 | 212.5 | 215 | 259 | 2.5 | 14 | □ | 2 |
| MPS1-1360-L15C | | 15 | 303 | 206.5 | 254.5 | 257 | 301 | 2.5 | 14 | □ | 2 |
| MPS1-1360-L20C | | 20 | 373 | 274.5 | 324.5 | 327 | 371 | 2.5 | 14 | □ | 2 |
| MPS1-1370S-DIN | 13.7 | 3 | 107 | 39.9 | 60 | 62 | 104.5 | 2.5 | 14 | □ | 4 |
| MPS1-1370S-DIN-C | | 3 | 107 | 39.9 | 60 | 62 | 104.5 | 2.5 | 14 | ● | 2 |
| MPS1-1370L-DIN | | 5 | 124 | 56.9 | 77 | 79 | 121.5 | 2.5 | 14 | □ | 4 |
| MPS1-1370L-DIN-C | | 5 | 124 | 56.9 | 77 | 79 | 121.5 | 2.5 | 14 | ● | 2 |
| MPS1-1370-PC | | 2 | 109 | 29.6 | 56.2 | 56 | 107 | 2.2 | 14 | □ | 2 |
| MPS1-1370-L8C | | 8 | 206 | 112.4 | 156 | 160 | 203 | 2.5 | 14 | ● | 2 |
| MPS1-1370-L10C | | 10 | 233 | 139.5 | 184.5 | 187 | 231 | 2.5 | 14 | □ | 2 |
| MPS1-1370-L12C | | 12 | 261 | 166.9 | 212.5 | 215 | 259 | 2.5 | 14 | □ | 2 |
| MPS1-1370-L15C | | 15 | 303 | 208 | 254.5 | 257 | 301 | 2.5 | 14 | □ | 2 |
| MPS1-1370-L20C | | 20 | 373 | 276.5 | 324.5 | 327 | 371 | 2.5 | 14 | □ | 2 |
| MPS1-1380S-DIN | 13.8 | 3 | 107 | 39.8 | 60 | 62 | 104.5 | 2.5 | 14 | □ | 4 |
| MPS1-1380S-DIN-C | | 3 | 107 | 39.8 | 60 | 62 | 104.5 | 2.5 | 14 | ● | 2 |
| MPS1-1380L-DIN | | 5 | 124 | 56.8 | 77 | 79 | 121.5 | 2.5 | 14 | □ | 4 |
| MPS1-1380L-DIN-C | | 5 | 124 | 56.8 | 77 | 79 | 121.5 | 2.5 | 14 | ● | 2 |
| MPS1-1380-PC | | 2 | 109 | 29.8 | 56.2 | 56 | 107 | 2.2 | 14 | □ | 2 |
| MPS1-1380-L8C | | 8 | 206 | 113.3 | 156 | 160 | 203 | 2.5 | 14 | ● | 2 |
| MPS1-1380-L10C | | 10 | 233 | 140.5 | 184.5 | 187 | 231 | 2.5 | 14 | □ | 2 |
| MPS1-1380-L12C | | 12 | 261 | 168.1 | 212.5 | 215 | 259 | 2.5 | 14 | □ | 2 |
| MPS1-1380-L15C | | 15 | 303 | 209.5 | 254.5 | 257 | 301 | 2.5 | 14 | □ | 2 |
| MPS1-1380-L20C | | 20 | 373 | 278.5 | 324.5 | 327 | 371 | 2.5 | 14 | □ | 2 |



MPS1

VOLLHARTMETALLBOHRER

| Bestellnummer | DC | (l/d) | OAL | LU | LCF | LH | LF | PL | DCON | DP1021 | Typ |
|------------------|------|-------|-----|-------|-------|-----|-------|-----|------|--------|-----|
| MPS1-1390S-DIN | 13.9 | 3 | 107 | 39.7 | 60 | 62 | 104.5 | 2.5 | 14 | □ | 4 |
| MPS1-1390S-DIN-C | | 3 | 107 | 39.7 | 60 | 62 | 104.5 | 2.5 | 14 | ● | 2 |
| MPS1-1390L-DIN | | 5 | 124 | 56.7 | 77 | 79 | 121.5 | 2.5 | 14 | □ | 4 |
| MPS1-1390L-DIN-C | | 5 | 124 | 56.7 | 77 | 79 | 121.5 | 2.5 | 14 | ● | 2 |
| MPS1-1390-PC | | 2 | 109 | 30 | 56.2 | 56 | 107 | 2.2 | 14 | □ | 2 |
| MPS1-1390-L8C | | 8 | 206 | 114.1 | 156 | 160 | 203 | 2.5 | 14 | ● | 2 |
| MPS1-1390-L10C | | 10 | 233 | 141.5 | 184.5 | 187 | 231 | 2.5 | 14 | □ | 2 |
| MPS1-1390-L12C | | 12 | 261 | 169.3 | 212.5 | 215 | 259 | 2.5 | 14 | □ | 2 |
| MPS1-1390-L15C | | 15 | 303 | 211 | 254.5 | 257 | 301 | 2.5 | 14 | □ | 2 |
| MPS1-1390-L20C | | 20 | 373 | 280.5 | 324.5 | 327 | 371 | 2.5 | 14 | □ | 2 |
| MPS1-1400S-DIN | 14 | 3 | 107 | 39.5 | 60 | 62 | 104.5 | 2.5 | 14 | □ | 4 |
| MPS1-1400S-DIN-C | | 3 | 107 | 39.5 | 60 | 62 | 104.5 | 2.5 | 14 | ● | 2 |
| MPS1-1400L-DIN | | 5 | 124 | 56.5 | 77 | 79 | 121.5 | 2.5 | 14 | □ | 4 |
| MPS1-1400L-DIN-C | | 5 | 124 | 56.5 | 77 | 79 | 121.5 | 2.5 | 14 | ● | 2 |
| MPS1-1400-PC | | 2 | 109 | 30.2 | 56.2 | 56 | 107 | 2.2 | 14 | ● | 2 |
| MPS1-1400-L8C | | 8 | 206 | 114.9 | 156 | 160 | 203 | 2.5 | 14 | ● | 2 |
| MPS1-1400-L10C | | 10 | 233 | 142.5 | 184.5 | 187 | 231 | 2.5 | 14 | □ | 2 |
| MPS1-1400-L12C | | 12 | 261 | 170.5 | 212.5 | 215 | 259 | 2.5 | 14 | ● | 2 |
| MPS1-1400-L15C | | 15 | 303 | 212.5 | 254.5 | 257 | 301 | 2.5 | 14 | ● | 2 |
| MPS1-1400-L20C | | 20 | 373 | 282.5 | 324.5 | 327 | 371 | 2.5 | 14 | ● | 2 |
| MPS1-1420S-DIN | 14.2 | 3 | 114 | 43.3 | 64 | 66 | 111.4 | 2.6 | 16 | □ | 4 |
| MPS1-1420S-DIN-C | | 3 | 114 | 43.3 | 64 | 66 | 111.4 | 2.6 | 16 | ● | 2 |
| MPS1-1420L-DIN | | 5 | 132 | 61.3 | 82 | 84 | 129.4 | 2.6 | 16 | □ | 4 |
| MPS1-1420L-DIN-C | | 5 | 132 | 61.3 | 82 | 84 | 129.4 | 2.6 | 16 | ● | 2 |
| MPS1-1450S-DIN | 14.5 | 3 | 114 | 42.9 | 64 | 66 | 111.4 | 2.6 | 16 | □ | 4 |
| MPS1-1450S-DIN-C | | 3 | 114 | 42.9 | 64 | 66 | 111.4 | 2.6 | 16 | ● | 2 |
| MPS1-1450L-DIN | | 5 | 132 | 60.9 | 82 | 84 | 129.4 | 2.6 | 16 | □ | 4 |
| MPS1-1450L-DIN-C | | 5 | 132 | 60.9 | 82 | 84 | 129.4 | 2.6 | 16 | ● | 2 |
| MPS1-1500S-DIN | 15 | 3 | 114 | 42.2 | 64 | 66 | 111.3 | 2.7 | 16 | □ | 4 |
| MPS1-1500S-DIN-C | | 3 | 114 | 42.2 | 64 | 66 | 111.3 | 2.7 | 16 | ● | 2 |
| MPS1-1500L-DIN | | 5 | 132 | 60.2 | 82 | 84 | 129.3 | 2.7 | 16 | □ | 4 |
| MPS1-1500L-DIN-C | | 5 | 132 | 60.2 | 82 | 84 | 129.3 | 2.7 | 16 | ● | 2 |
| MPS1-1550S-DIN | 15.5 | 3 | 115 | 41.6 | 65 | 67 | 112.2 | 2.8 | 16 | □ | 4 |
| MPS1-1550S-DIN-C | | 3 | 115 | 41.6 | 65 | 67 | 112.2 | 2.8 | 16 | ● | 2 |
| MPS1-1550L-DIN | | 5 | 133 | 59.6 | 83 | 85 | 130.2 | 2.8 | 16 | □ | 4 |
| MPS1-1550L-DIN-C | | 5 | 133 | 59.6 | 83 | 85 | 130.2 | 2.8 | 16 | ● | 2 |
| MPS1-1600S-DIN | 16 | 3 | 115 | 40.9 | 65 | 67 | 112.1 | 2.9 | 16 | □ | 4 |
| MPS1-1600S-DIN-C | | 3 | 115 | 40.9 | 65 | 67 | 112.1 | 2.9 | 16 | ● | 2 |
| MPS1-1600L-DIN | | 5 | 133 | 58.9 | 83 | 85 | 130.1 | 2.9 | 16 | □ | 4 |
| MPS1-1600L-DIN-C | | 5 | 133 | 58.9 | 83 | 85 | 130.1 | 2.9 | 16 | ● | 2 |
| MPS1-1650S-DIN | 16.5 | 3 | 123 | 48.3 | 73 | 75 | 120 | 3.0 | 18 | □ | 4 |
| MPS1-1650S-DIN-C | | 3 | 123 | 48.3 | 73 | 75 | 120 | 3.0 | 18 | ● | 2 |
| MPS1-1650L-DIN | | 5 | 143 | 68.3 | 93 | 95 | 140 | 3.0 | 18 | □ | 4 |
| MPS1-1650L-DIN-C | | 5 | 143 | 68.3 | 93 | 95 | 140 | 3.0 | 18 | ● | 2 |
| MPS1-1700S-DIN | 17 | 3 | 123 | 47.6 | 73 | 75 | 119.9 | 3.1 | 18 | □ | 4 |
| MPS1-1700S-DIN-C | | 3 | 123 | 47.6 | 73 | 75 | 119.9 | 3.1 | 18 | ● | 2 |
| MPS1-1700L-DIN | | 5 | 143 | 67.6 | 93 | 95 | 139.9 | 3.1 | 18 | □ | 4 |
| MPS1-1700L-DIN-C | | 5 | 143 | 67.6 | 93 | 95 | 139.9 | 3.1 | 18 | ● | 2 |

MPS1

VOLLHARTMETALLBOHRER

| Bestellnummer | DC | (l/d) | OAL | LU | LCF | LH | LF | PL | DCON | DP1021 | Typ |
|------------------|------|-------|-----|------|-----|-----|-------|-----|------|--------|-----|
| MPS1-1750S-DIN | 17.5 | 3 | 123 | 46.9 | 73 | 75 | 119.8 | 3.2 | 18 | □ | 4 |
| MPS1-1750S-DIN-C | | 3 | 123 | 46.9 | 73 | 75 | 119.8 | 3.2 | 18 | ● | 2 |
| MPS1-1750L-DIN | | 5 | 143 | 66.9 | 93 | 95 | 139.8 | 3.2 | 18 | □ | 4 |
| MPS1-1750L-DIN-C | | 5 | 143 | 66.9 | 93 | 95 | 139.8 | 3.2 | 18 | ● | 2 |
| MPS1-1800S-DIN | 18 | 3 | 123 | 46.3 | 73 | 75 | 119.7 | 3.3 | 18 | □ | 4 |
| MPS1-1800S-DIN-C | | 3 | 123 | 46.3 | 73 | 75 | 119.7 | 3.3 | 18 | ● | 2 |
| MPS1-1800L-DIN | | 5 | 143 | 66.3 | 93 | 95 | 139.7 | 3.3 | 18 | □ | 4 |
| MPS1-1800L-DIN-C | | 5 | 143 | 66.3 | 93 | 95 | 139.7 | 3.3 | 18 | ● | 2 |
| MPS1-1850S-DIN | 18.5 | 3 | 131 | 51.6 | 79 | 81 | 127.6 | 3.4 | 20 | □ | 4 |
| MPS1-1850S-DIN-C | | 3 | 131 | 51.6 | 79 | 81 | 127.6 | 3.4 | 20 | ● | 2 |
| MPS1-1850L-DIN | | 5 | 153 | 73.6 | 101 | 103 | 149.6 | 3.4 | 20 | □ | 4 |
| MPS1-1850L-DIN-C | | 5 | 153 | 73.6 | 101 | 103 | 149.6 | 3.4 | 20 | ● | 2 |
| MPS1-1900S-DIN | 19 | 3 | 131 | 51.0 | 79 | 81 | 127.5 | 3.5 | 20 | □ | 4 |
| MPS1-1900S-DIN-C | | 3 | 131 | 51.0 | 79 | 81 | 127.5 | 3.5 | 20 | ● | 2 |
| MPS1-1900L-DIN | | 5 | 153 | 73.0 | 101 | 103 | 149.5 | 3.5 | 20 | □ | 4 |
| MPS1-1900L-DIN-C | | 5 | 153 | 73.0 | 101 | 103 | 149.5 | 3.5 | 20 | ● | 2 |
| MPS1-1950S-DIN | 19.5 | 3 | 131 | 50.3 | 79 | 81 | 127.5 | 3.5 | 20 | □ | 4 |
| MPS1-1950S-DIN-C | | 3 | 131 | 50.3 | 79 | 81 | 127.5 | 3.5 | 20 | ● | 2 |
| MPS1-1950L-DIN | | 5 | 153 | 72.3 | 101 | 103 | 149.5 | 3.5 | 20 | □ | 4 |
| MPS1-1950L-DIN-C | | 5 | 153 | 72.3 | 101 | 103 | 149.5 | 3.5 | 20 | ● | 2 |
| MPS1-2000S-DIN | 20 | 3 | 131 | 49.6 | 79 | 81 | 127.4 | 3.6 | 20 | □ | 4 |
| MPS1-2000S-DIN-C | | 3 | 131 | 49.6 | 79 | 81 | 127.4 | 3.6 | 20 | ● | 2 |
| MPS1-2000L-DIN | | 5 | 153 | 71.6 | 101 | 103 | 149.4 | 3.6 | 20 | □ | 4 |
| MPS1-2000L-DIN-C | | 5 | 153 | 71.6 | 101 | 103 | 149.4 | 3.6 | 20 | ● | 2 |



MPS1

SCHNITTDATENEMPFEHLUNGEN

| Material | Eigenschaften | DC | L x DC | Vc | f |
|-----------------------------|---------------|---------------|------------------|---------------|------------------|
| Stahl | <180HB | 3 | 3-8 | 100 (60-150) | 0.15 (0.10-0.20) |
| | | | 10-25 | 90 (40-110) | 0.17 (0.10-0.24) |
| | | | 30-40 | 75 (40- 95) | 0.14 (0.08-0.19) |
| | | 4 | 3-8 | 120 (70-170) | 0.19 (0.12-0.25) |
| | | | 10-25 | 90 (40-110) | 0.20 (0.12-0.30) |
| | | | 30-40 | 75 (40- 95) | 0.16 (0.10-0.24) |
| | | 5 | 3-8 | 130 (80-190) | 0.23 (0.15-0.30) |
| | | | 10-25 | 90 (40-110) | 0.25 (0.15-0.35) |
| | | | 30-40 | 75 (40- 95) | 0.20 (0.12-0.28) |
| | | 6 | 3-8 | 140 (90-210) | 0.27 (0.18-0.35) |
| | | | 10-25 | 110 (70-120) | 0.27 (0.17-0.37) |
| | | | 30-40 | 90 (40-110) | 0.22 (0.14-0.30) |
| | | 8 | 3-8 | 160 (100-240) | 0.30 (0.20-0.40) |
| | | | 10-25 | 110 (70-120) | 0.30 (0.20-0.40) |
| | | | 30-40 | 90 (40-110) | 0.24 (0.16-0.32) |
| | | 10 | 3-8 | 170 (100-250) | 0.33 (0.20-0.45) |
| | | | 10-25 | 110 (70-120) | 0.32 (0.22-0.42) |
| | | | 30-40 | 90 (40-110) | 0.26 (0.18-0.34) |
| | | 12 | 3-8 | 180 (100-250) | 0.35 (0.20-0.50) |
| | | | 10-25 | 130 (90-150) | 0.34 (0.24-0.44) |
| 30-40 | 105 (55-125) | | 0.27 (0.19-0.35) | | |
| 16 | 3-8 | 180 (100-250) | 0.38 (0.20-0.55) | | |
| | 10-25 | 130 (90-150) | 0.36 (0.26-0.46) | | |
| 20 | 3-8 | 180 (100-250) | 0.40 (0.20-0.60) | | |
| C-Stahl, Legierter Stahl | 180-250HB | 3 | 3-8 | 90 (60-140) | 0.15 (0.10-0.19) |
| | | | 10-25 | 90 (40-110) | 0.17 (0.10-0.24) |
| | | | 30-40 | 75 (40- 85) | 0.14 (0.08-0.19) |
| | | 4 | 3-8 | 100 (70-160) | 0.18 (0.12-0.24) |
| | | | 10-25 | 90 (40-110) | 0.20 (0.12-0.30) |
| | | | 30-40 | 75 (40- 85) | 0.16 (0.10-0.24) |
| | | 5 | 3-8 | 110 (80-180) | 0.22 (0.15-0.29) |
| | | | 10-25 | 90 (40-110) | 0.25 (0.15-0.35) |
| | | | 30-40 | 75 (40- 85) | 0.20 (0.12-0.28) |
| | | 6 | 3-8 | 120 (90-190) | 0.26 (0.18-0.33) |
| | | | 10-25 | 100 (60-110) | 0.24 (0.15-0.33) |
| | | | 30-40 | 80 (40- 90) | 0.22 (0.14-0.30) |
| | | 8 | 3-8 | 140 (100-220) | 0.29 (0.20-0.38) |
| | | | 10-25 | 100 (60-110) | 0.30 (0.20-0.40) |
| | | | 30-40 | 80 (40- 90) | 0.24 (0.16-0.32) |
| | | 10 | 3-8 | 150 (100-230) | 0.32 (0.20-0.43) |
| | | | 10-25 | 100 (60-110) | 0.32 (0.22-0.42) |
| | | | 30-40 | 80 (40- 90) | 0.26 (0.18-0.34) |
| | | 12 | 3-8 | 160 (100-230) | 0.34 (0.20-0.48) |
| | | | 10-25 | 120 (80-140) | 0.34 (0.24-0.44) |
| 30-40 | 95 (55-105) | | 0.27 (0.19-0.35) | | |
| 16 | 3-8 | 160 (100-230) | 0.36 (0.20-0.52) | | |
| | 10-25 | 120 (80-140) | 0.36 (0.26-0.46) | | |
| 20 | 3-8 | 160 (100-230) | 0.39 (0.20-0.57) | | |

MPS1

| Material | Eigenschaften | DC | L x DC | Vc | f |
|-------------------------------|---------------|---------------|------------------|---------------|------------------|
| P C-Stahl, Legierter Stahl | 280-350 HB | 3 | 3-8 | 80 (50-110) | 0.12 (0.10-0.14) |
| | | | 10-25 | 80 (40- 90) | 0.15 (0.09-0.22) |
| | | | 30-40 | 65 (40- 75) | 0.15 (0.07-0.18) |
| | | 4 | 3-8 | 90 (60-120) | 0.15 (0.12-0.18) |
| | | | 10-25 | 80 (40- 90) | 0.18 (0.11-0.27) |
| | | | 30-40 | 65 (40- 75) | 0.18 (0.09-0.22) |
| | | 5 | 3-8 | 90 (70-140) | 0.19 (0.15-0.22) |
| | | | 10-25 | 80 (40- 90) | 0.22 (0.14-0.32) |
| | | | 30-40 | 65 (40- 75) | 0.22 (0.11-0.26) |
| | | 6 | 3-8 | 100 (80-150) | 0.22 (0.18-0.25) |
| | | | 10-25 | 90 (40-110) | 0.24 (0.15-0.33) |
| | | | 30-40 | 75 (40- 85) | 0.24 (0.12-0.26) |
| | | 8 | 3-8 | 120 (90-170) | 0.24 (0.20-0.27) |
| | | | 10-25 | 90 (40-110) | 0.27 (0.18-0.36) |
| | | | 30-40 | 75 (40- 85) | 0.27 (0.14-0.29) |
| | | 10 | 3-8 | 130 (90-180) | 0.25 (0.20-0.30) |
| | | | 10-25 | 90 (40-110) | 0.29 (0.20-0.38) |
| | | | 30-40 | 75 (40- 95) | 0.29 (0.16-0.30) |
| | | 12 | 3-8 | 140 (90-180) | 0.27 (0.20-0.34) |
| | | | 10-25 | 100 (60-110) | 0.30 (0.22-0.40) |
| 30-40 | 80 (40-100) | | 0.30 (0.18-0.32) | | |
| 16 | 3-8 | 140 (90-180) | 0.28 (0.20-0.36) | | |
| | 10-25 | 100 (60-110) | 0.32 (0.23-0.41) | | |
| 20 | 3-8 | 140 (90-180) | 0.30 (0.20-0.40) | | |
| M Rostfreier Stahl | | 3 | 3-8 | 40 (20- 50) | 0.08 (0.06-0.12) |
| | | | 10-25 | 40 (20- 60) | 0.07 (0.05-0.09) |
| | | | 30-40 | 30 (20- 50) | 0.06 (0.04-0.07) |
| | | 4 | 3-8 | 40 (30- 50) | 0.09 (0.07-0.13) |
| | | | 10-25 | 40 (20- 60) | 0.08 (0.06-0.10) |
| | | | 30-40 | 30 (20- 50) | 0.06 (0.05-0.08) |
| | | 5 | 3-8 | 40 (30- 50) | 0.11 (0.08-0.16) |
| | | | 10-25 | 40 (20- 60) | 0.10 (0.07-0.12) |
| | | | 30-40 | 30 (20- 50) | 0.08 (0.06-0.10) |
| | | 6 | 3-8 | 50 (40- 70) | 0.14 (0.11-0.18) |
| | | | 10-25 | 50 (20- 60) | 0.12 (0.08-0.16) |
| | | | 30-40 | 40 (20- 60) | 0.10 (0.06-0.13) |
| | | 8 | 3-8 | 50 (40- 70) | 0.15 (0.12-0.20) |
| | | | 10-25 | 50 (20- 60) | 0.14 (0.10-0.17) |
| | | | 30-40 | 40 (20- 50) | 0.11 (0.08-0.14) |
| | | 10 | 3-8 | 50 (40- 70) | 0.16 (0.12-0.22) |
| | | | 10-25 | 50 (20- 60) | 0.15 (0.12-0.18) |
| | | | 30-40 | 40 (20- 50) | 0.12 (0.10-0.14) |
| | | 12 | 3-8 | 50 (40- 70) | 0.18 (0.14-0.24) |
| | | | 10-25 | 60 (25- 65) | 0.17 (0.14-0.19) |
| | | | 30-40 | 50 (20- 60) | 0.14 (0.11-0.15) |
| | | 16 | 3-8 | 50 (40- 70) | 0.19 (0.15-0.26) |
| | | | 10-25 | 60 (25- 65) | 0.17 (0.14-0.19) |
| | | 20 | 3-8 | 50 (40- 70) | 0.21 (0.16-0.28) |

MPS1

| Material | Eigenschaften | DC | L x DC | Vc | f |
|----------------------|---------------|---------------|------------------|---------------|------------------|
| K Gusseisen | ≤ 350 MPa | 3 | 3-8 | 90 (60-100) | 0.15 (0.10-0.20) |
| | | | 10-25 | 90 (40-110) | 0.19 (0.11-0.26) |
| | | | 30-40 | 75 (45- 95) | 0.15 (0.09-0.21) |
| | | 4 | 3-8 | 100 (70-110) | 0.21 (0.12-0.30) |
| | | | 10-25 | 90 (40-110) | 0.22 (0.13-0.33) |
| | | | 30-40 | 75 (45- 95) | 0.18 (0.10-0.26) |
| | | 5 | 3-8 | 110 (80-130) | 0.25 (0.15-0.35) |
| | | | 10-25 | 90 (40-110) | 0.28 (0.17-0.39) |
| | | | 30-40 | 75 (45- 95) | 0.22 (0.13-0.31) |
| | | 6 | 3-8 | 120 (90-140) | 0.29 (0.18-0.40) |
| | | | 10-25 | 100 (60-110) | 0.30 (0.19-0.41) |
| | | | 30-40 | 90 (60-110) | 0.24 (0.15-0.33) |
| | | 8 | 3-8 | 140 (100-160) | 0.33 (0.20-0.45) |
| | | | 10-25 | 100 (60-110) | 0.33 (0.22-0.44) |
| | | | 30-40 | 90 (60-100) | 0.26 (0.18-0.35) |
| | | 10 | 3-8 | 150 (100-170) | 0.35 (0.20-0.50) |
| | | | 10-25 | 100 (60-110) | 0.35 (0.24-0.46) |
| | | | 30-40 | 90 (60-100) | 0.28 (0.19-0.37) |
| | | 12 | 3-8 | 160 (100-170) | 0.40 (0.20-0.60) |
| | | | 10-25 | 120 (90-140) | 0.37 (0.26-0.48) |
| | | | 30-40 | 105 (65-115) | 0.30 (0.21-0.38) |
| 16 | 3-8 | 160 (100-170) | 0.43 (0.20-0.65) | | |
| | 10-25 | 120 (90-140) | 0.40 (0.29-0.48) | | |
| 20 | 3-8 | 160 (100-170) | 0.45 (0.20-0.70) | | |
| K Duktiles Gusseisen | ≤ 450 MPa | 3 | 3-8 | 80 (50- 90) | 0.12 (0.08-0.16) |
| | | | 10-25 | 90 (40-110) | 0.17 (0.10-0.24) |
| | | | 30-40 | 30 (20- 50) | 0.14 (0.08-0.19) |
| | | 4 | 3-8 | 90 (60-100) | 0.17 (0.10-0.24) |
| | | | 10-25 | 90 (40-110) | 0.20 (0.12-0.30) |
| | | | 30-40 | 30 (20- 50) | 0.16 (0.10-0.24) |
| | | 5 | 3-8 | 90 (70-120) | 0.21 (0.14-0.28) |
| | | | 10-25 | 90 (40-110) | 0.25 (0.15-0.35) |
| | | | 30-40 | 30 (20- 50) | 0.20 (0.12-0.28) |
| | | 6 | 3-8 | 100 (80-130) | 0.25 (0.16-0.34) |
| | | | 10-25 | 100 (60-110) | 0.27 (0.17-0.37) |
| | | | 30-40 | 40 (30- 60) | 0.22 (0.14-0.30) |
| | | 8 | 3-8 | 120 (90-150) | 0.28 (0.18-0.38) |
| | | | 10-25 | 100 (60-110) | 0.30 (0.20-0.40) |
| | | | 30-40 | 40 (30- 60) | 0.24 (0.16-0.32) |
| | | 10 | 3-8 | 130 (90-160) | 0.29 (0.18-0.40) |
| | | | 10-25 | 100 (60-110) | 0.32 (0.22-0.42) |
| | | | 30-40 | 40 (30- 60) | 0.26 (0.18-0.34) |
| | | 12 | 3-8 | 140 (90-160) | 0.31 (0.18-0.44) |
| | | | 10-25 | 120 (90-140) | 0.34 (0.24-0.44) |
| | | | 30-40 | 50 (40- 70) | 0.27 (0.19-0.35) |
| 16 | 3-8 | 140 (90-160) | 0.33 (0.18-0.48) | | |
| | 10-25 | 120 (90-140) | 0.36 (0.26-0.46) | | |
| 20 | 3-8 | 140 (90-160) | 0.35 (0.18-0.52) | | |

MPS1

| Material | Eigenschaften | DC | L x DC | Vc | f |
|----------------------|---------------|----|--------|---------------|------------------|
| K Duktiles Gusseisen | ≤ 800 MPa | 3 | 3-8 | 60 (40- 80) | 0.09 (0.06-0.12) |
| | | 4 | 3-8 | 70 (50- 90) | 0.13 (0.08-0.18) |
| | | 5 | 3-8 | 70 (60-100) | 0.17 (0.12-0.22) |
| | | 6 | 3-8 | 80 (70-110) | 0.20 (0.14-0.26) |
| | | 8 | 3-8 | 100 (80-130) | 0.23 (0.16-0.30) |
| | | 10 | 3-8 | 110 (80-140) | 0.24 (0.16-0.32) |
| | | 12 | 3-8 | 110 (80-140) | 0.25 (0.16-0.34) |
| | | 16 | 3-8 | 110 (80-140) | 0.27 (0.16-0.38) |
| | | 20 | 3-8 | 110 (80-140) | 0.28 (0.16-0.40) |

MPS1

BENUTZERHINWEISE

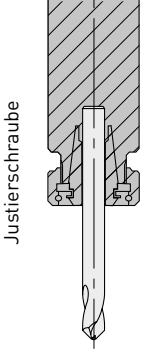
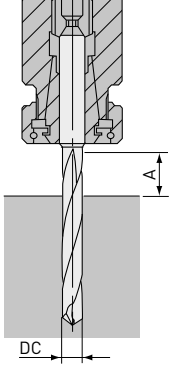
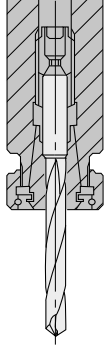
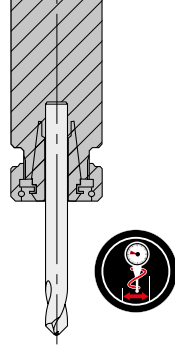
| BOHRER-AUFNAHME | MAX. BOHRTIEFE | SPANNEN DES BOHRERS | RUNDLAUFTOLERANZ |
|--|---|---|---|
|  <p>Justierschraube</p> |  |  |  |
| <p>Präzisionsspannzangen können verwendet werden. Wir empfehlen den Einsatz von Kraftspannfutter.</p> | <p>$A \geq DC \times 1.5$</p> | <p>Nicht auf den Spiralnuten spannen.</p> | <p>Rundlaufabweichung ≤ 0.03 mm</p> |

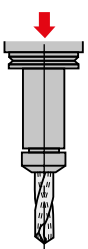
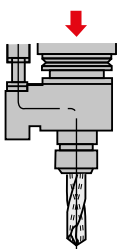
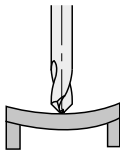
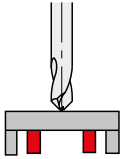
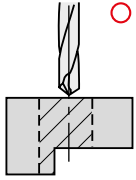
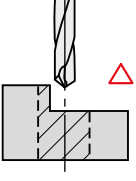
| INTERNE KÜHLMITTELZUFUHR | KÜHLMITTELZUFUHR | DÜNNE WERKSTÜCKE | BOHREN MIT SCHNITTUNTERBRECHUNG |
|---|--|---|--|
| <p>Kühlmittelezufuhr durch die Spindel</p>  <p>Kühlmittelezufuhr durch spezielle Aufnahmen.</p>  <p>Empfohlener Kühlmitteldruck ca. 0.5–1 MPa (<math>\varnothing 5:</math>2–3 MPa).</p> | <ol style="list-style-type: none"> 1. Kleine Partikel können die Kühlmittelebohrungen verstopfen. Verwenden Sie daher bitte einen Kühlmittelfilter. 2. Stark verschmutztes Kühlmittel reduziert den Spänefluss. Daher wird ein regelmäßiger Austausch des Kühlmittels empfohlen. | <p>Falls sich Werkstücke verbiegen,</p>  <p>stützen Sie diese entsprechend ab.</p>  | <p>Ohne Vorbearbeitung</p>  <p>Benötigt Vorbearbeitung (z.B. Anspiegeln)</p>  |

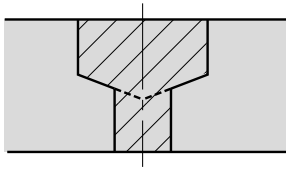
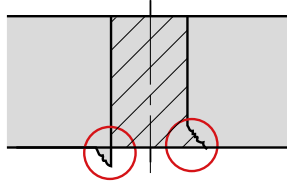
| STUFENBOHRUNG | STARKE GRATBILDUNG UND AUSBRÜCHE |
|--|--|
|  |  |
| <ol style="list-style-type: none"> 1. Zwei Arbeitsschritte: 2. Bohren Sie zuerst die größere Bohrung. 3. Stufenbohrer für eine Bearbeitung in einem Prozess können kundenspezifisch auf Anfrage hergestellt werden. | <ol style="list-style-type: none"> 1. Reduzieren Sie den Vorschub am Austritt der Bohrung um 50 %. 2. Erzeugen Sie eine Faser von 45°. 3. Ändern Sie den Spitzenwinkel. |



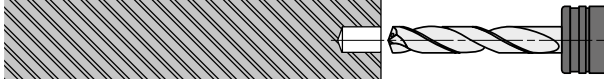
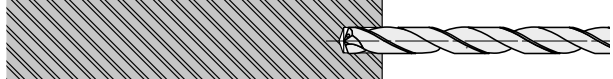
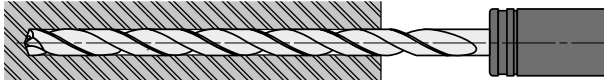
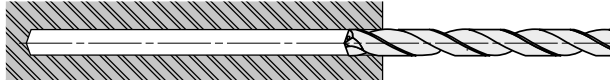

MPS1

VERWENDUNG VON SUPER LONG BOHRERN

SACKLOCHBOHRUNG SETZEN

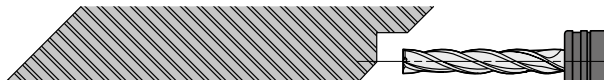
| | |
|---|---|
| 1. Pilotbohrung setzen | 2. Einfahren in die Pilotbohrung |
|  |  |
| <ol style="list-style-type: none"> 1. Für die Pilotbohrungen empfehlen wir den Einsatz von Mitsubishi Bohrern Typ MPS1 (PC). 2. Bitte stellen Sie eine präzise Pilotbohrung her, um einen einwandfreien Prozess beim Tieflochbohren zu gewährleisten. 3. Pilotbohrung: Min. 1 x DC oder tiefer. (Passen Sie die Tiefe der Pilotbohrung der Länge Ihres SuperLong Bohrers an) | <ol style="list-style-type: none"> 1. Mit niedriger Drehzahl in die Pilotbohrung einfahren. (Schnittgeschwindigkeit 20–30 m/min, Vorschub 0.2–0.3 mm/U) 2. Tieflochbohrer 1–3 mm vor dem Boden des Führungslochs stoppen. |
| 3. Tieflochbohren | 4. Herausfahren des Bohrers |
|  |  |
| <ol style="list-style-type: none"> 1. Mit den empfohlenen Schnittdaten bis zur gewünschten Bohrungstiefe bohren. | <ol style="list-style-type: none"> 1. Nach dem Bohren Schnittgeschwindigkeit etwa 1–2 mm vom Bohrungsende entfernt reduzieren (Schnittgeschw. 20–30 m/min.) 2. Fahren Sie den Bohrer bis zur Tiefe der Pilotbohrung heraus (Vf = 3000 mm/min.) 3. Fahren Sie den Bohrer aus der Pilotbohrung mit geringer Drehzahl (n = 300, Vf = 3000 mm/min) |

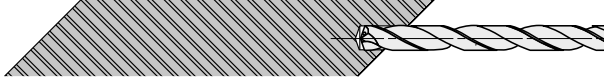
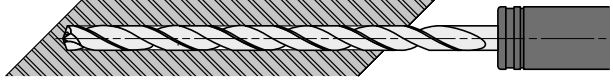
BOHRUNGEN IN ANGEWINKELTEN WERKSTÜCKEN

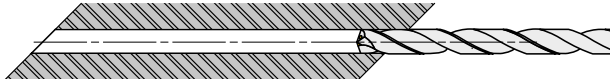
| | |
|--|---|
| 1. Anspiegeln | 2. Pilotbohrung setzen |
|  |  |
| <ol style="list-style-type: none"> 1. Fräsen Sie eine ebene Fläche in das Werkstück und setzen Sie einen Fräser mit gleichem Durchmesser wie die gewünschte Bohrung ein. | <ol style="list-style-type: none"> 1. Für die Pilotbohrungen empfehlen wir den Einsatz von Mitsubishi Bohrern Typ MPS1 (PC). 2. Bitte stellen Sie eine präzise Pilotbohrung her, um einen einwandfreien Prozess beim Tieflochbohren zu gewährleisten. 3. Pilotbohrung: Min. 1 x DC oder tiefer. (Passen Sie die Tiefe der Pilotbohrung der Länge Ihres SuperLong Bohrers an) |
| 3. Einfahren in die Pilotbohrung | 4. Tieflochbohren |
|  |  |
| <ol style="list-style-type: none"> 1. Mit niedriger Drehzahl in die Pilotbohrung einfahren. (Schnittgeschwindigkeit 20–30 m/min, Vorschub 0.2–0.3 mm/U) 2. Langbohrer 1–3mm vor dem Boden des Führungslochs stoppen. | <ol style="list-style-type: none"> 1. Mit den empfohlenen Schnittdaten bis zur gewünschten Bohrungstiefe bohren. 2. Vorschub bis vor dem Durchbruch beibehalten. |
| 5. Durchbohren | 6. Herausfahren des Bohrers |
|  |  |
| <ol style="list-style-type: none"> 1. Beim Austritt aus dem Werkstück kann die Schneidkante des Bohrers ausbrechen. 2. Reduzieren Sie den Vorschub auf f = 0.05mm–0.1 mm/U | <ol style="list-style-type: none"> 1. Bohrer auf Pilotbohrung-Startpunkttiefe herausziehen bei einem Vorschub von 3000 mm/min. 2. Dann Bohrung mit einer Schnittgeschw. von 20–30 m/min und einem Vorschub von 0.2–0.3 mm/U herausfahren. |

GERMANY

MMC HARTMETALL GMBH
Comeniusstr. 2 . 40670 Meerbusch
Phone +49 2159 91890 . Fax +49 2159 918966
Email admin@mmchg.de

U.K.

MMC HARDMETAL U.K. LTD.
Mitsubishi House . Galena Close . Tamworth . Staffs. B77 4AS
Phone +44 1827 312312 . Fax +44 1827 312314
Email sales@mitsubishicarbide.co.uk

SPAIN

mitsubishi MATERIALS ESPAÑA, S.A.
Calle Emperador 2 . 46136 Museros/Valencia
Phone +34 96 1441711 . Fax +34 96 1443786
Email comercial@mmevalencia.es

FRANCE

MMC METAL FRANCE S.A.R.L.
6, Rue Jacques Monod . 91400 Orsay
Phone +33 1 69 35 53 53 . Fax +33 1 69 35 53 50
Email mmfsales@mmc-metal-france.fr

POLAND

MMC HARDMETAL POLAND SP. Z O.O
Al. Armii Krajowej 61 . 50-541 Wrocław
Phone +48 71335 1620 . Fax +48 71335 1621
Email sales@mitsubishicarbide.com.pl

RUSSIA

MMC HARDMETAL 000 LTD.
Electrozavodskaya St. 24 . build. 3 . Moscow . 107023
Phone +7 495 725 58 85 . Fax +7 495 981 39 79
Email info@mmc-carbide.ru

ITALY

MMC ITALIA S.R.L.
Via Montefeltro 6/A . 20156 Milano
Phone +39 0293 77031 . Fax +39 0293 589093
Email info@mmc-italia.it

TURKEY

MMC HARTMETALL GMBH ALMANYA - İZMİR MERKEZ ŞUBESİ
Adalet Mahallesi Anadolu Caddesi No: 41-1 . 15001 35580 Bayraklı /İzmir
Phone +90 232 5015000 . Fax +90 232 5015007
Email info@mmchg.com.tr

www.mitsubishicarbide.com | www.mmc-hardmetal.com

VERTRIEB DURCH:

┌

┐

└

┘