

可转位钻头

TAF 钻头

增加
VP15TF
U2断屑槽!!

使用4个刃角刀片，经济性好。

切削噪音小，刀柄刚性高。

■ 增加MIRACLE涂层VP15TF (U2断屑槽)，
进一步实现稳定加工。



0.1mm间隔的
增径专用滑套
库存品

可根据设定的直径
从0.1mm间隔、最大增径
0.5mm的5个尺寸中选择。

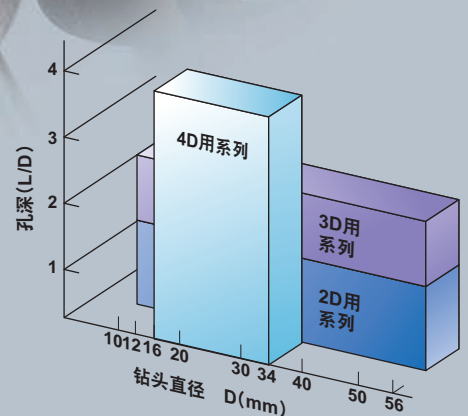

可转位钻头

TAF 钻头



■ 特点

强固的刀体

- ① 钻心厚度最优化设计，不易发生高频振动，切削噪音小。
- ② 刀体与刀片座的刚性高，不易损坏。

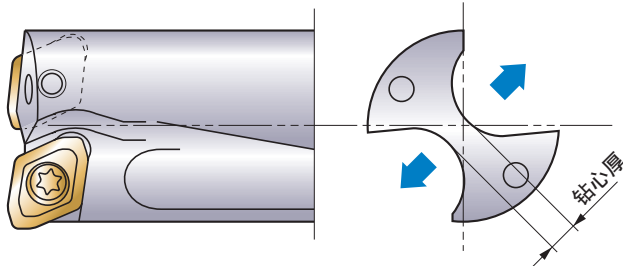

经济性好的刀片

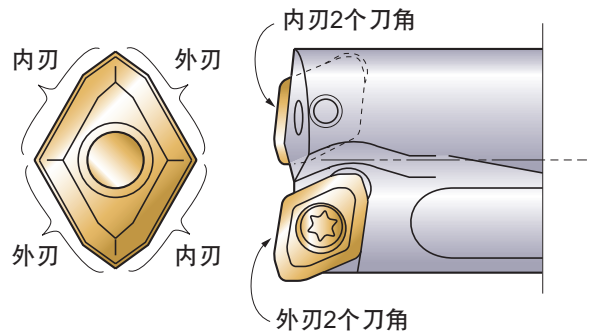

使用4个刃角的刀片，经济性好

对应不同条件的组合

断屑槽	材料 NEW		UP20M		GP20M		UE6020		US735		F5010	
	GCMT	GPMT	GCMT	GPMT	GCMT	GPMT	GCMT	GPMT	GCMT	GPMT	GCMT	GPMT
U1			软钢	软钢								
U2	碳钢 合金钢 不锈钢 铸铁 球墨铸铁	不锈钢			碳钢 合金钢 不锈钢 铸铁 球墨铸铁					不锈钢		
U3				球墨铸铁					碳钢 合金钢			铸铁 球墨铸铁

* 上述为第一推荐。详细内容请参照第7页。

■ 型号

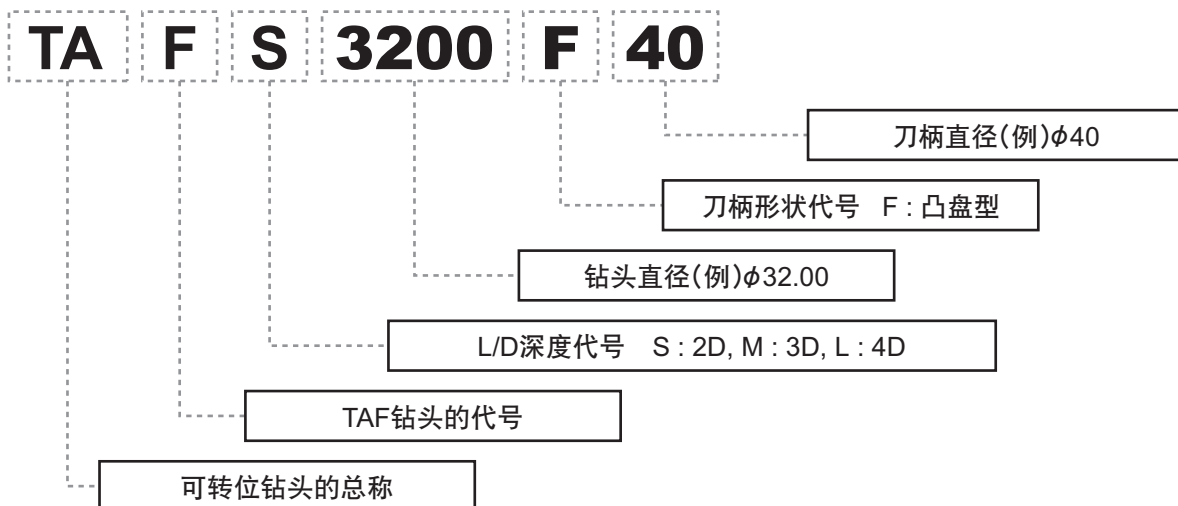

切削性能

●切屑形态

钻头直径： $\phi 25$

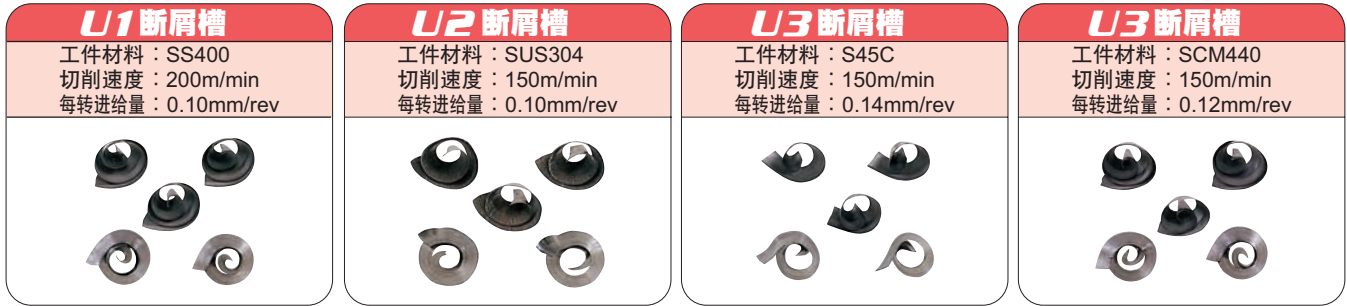

●切削力

工件材料：SCM440(HB200-220) 切削速度：150m/min 刀片：U2断屑槽

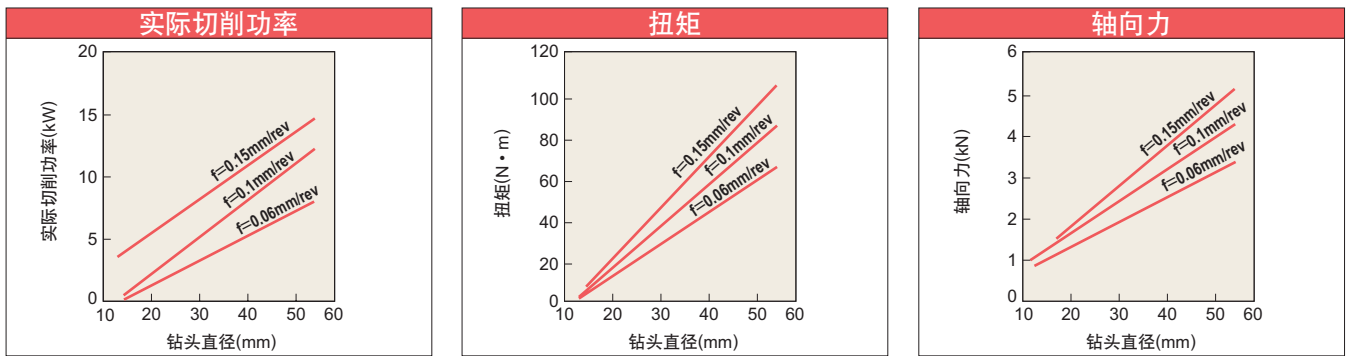

●切削噪音

工件材料：SCM440(HB200-220) 钻头直径： $\phi 25$ 刀片：U2断屑槽 切削速度：150m/min

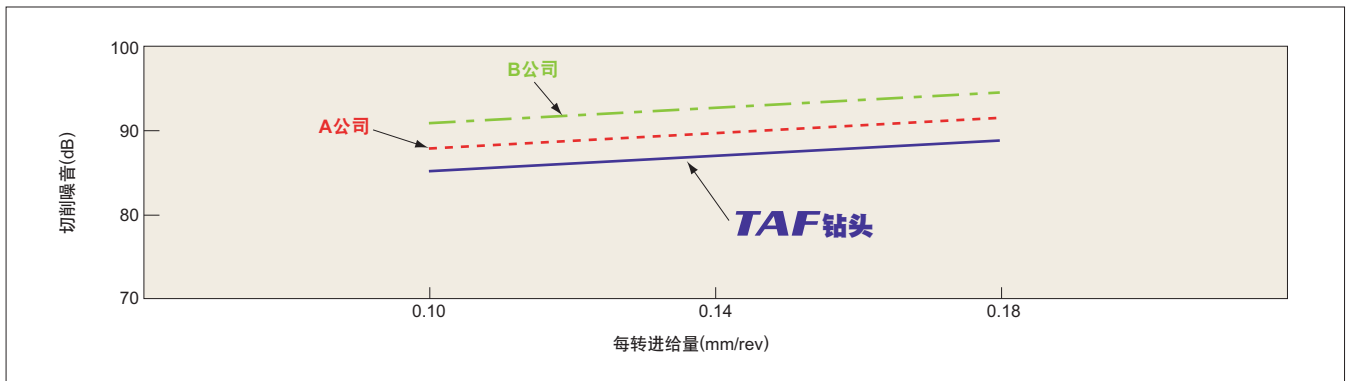

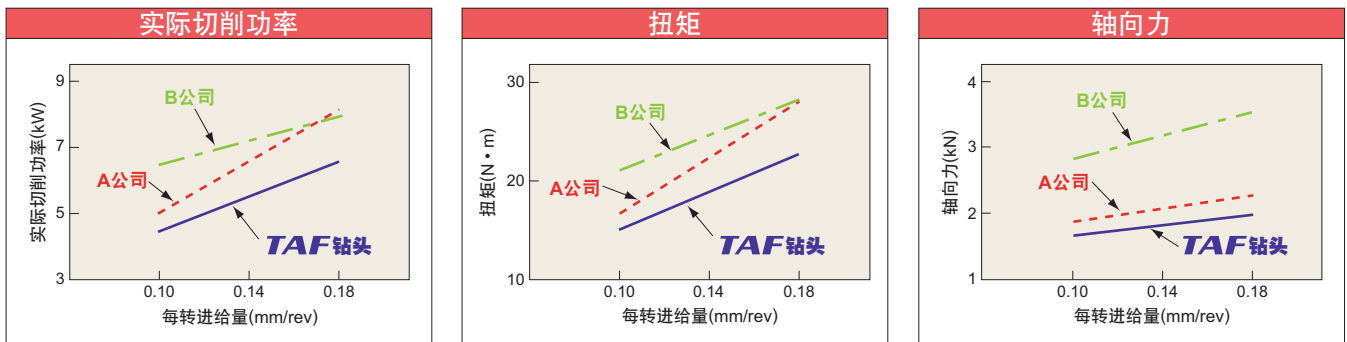

●切削力的比较

工件材料：SCM440(HB200-220) 钻头直径： $\phi 25$ 刀片：U3断屑槽 切削速度：150m/min

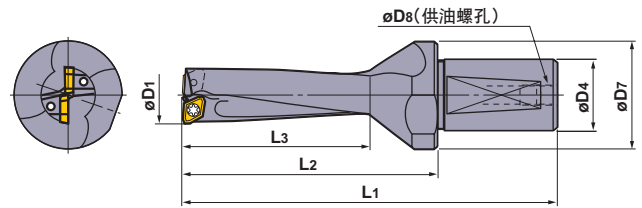
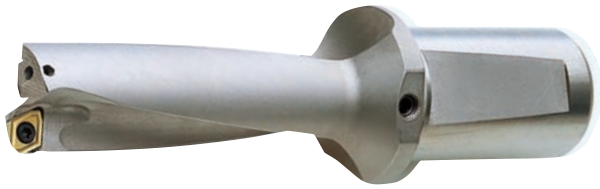

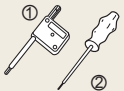

钻头直径 D1 (mm)	钻削孔深 (l/d)	型号	库存	刃数	尺寸 (mm)						刀片型号	 夹紧螺钉	 扳手
					有效槽长	颈长	全长	柄径	刃尖直径	供油孔			
					L3	L2	L1	D4	D7	D8			
12.0	2	TAFS1200F20	●	2	29	39	82	20	25	PT1/8	GCMT040204-U	TS2	TKY06F
	3	TAFM1200F20	●	2	41	51	94	20	25	PT1/8	GCMT040204-U	TS2	TKY06F
12.5	2	TAFS1250F20	●	2	29	39	82	20	25	PT1/8	GCMT040204-U	TS2	TKY06F
	3	TAFM1250F20	●	2	41	51	94	20	25	PT1/8	GCMT040204-U	TS2	TKY06F
13.0	2	TAFS1300F20	●	2	31	41	84	20	25	PT1/8	GCMT040204-U	TS2	TKY06F
	3	TAFM1300F20	●	2	44	54	97	20	25	PT1/8	GCMT040204-U	TS2	TKY06F
13.5	2	TAFS1350F20	●	2	31	41	84	20	25	PT1/8	GCMT040204-U	TS2	TKY06F
	3	TAFM1350F20	●	2	44	54	97	20	25	PT1/8	GCMT040204-U	TS2	TKY06F
14.0	2	TAFS1400F20	●	2	33	43	86	20	25	PT1/8	GCMT040204-U	TS2	TKY06F
	3	TAFM1400F20	●	2	47	57	100	20	25	PT1/8	GCMT040204-U	TS2	TKY06F
14.5	2	TAFS1450F20	●	2	33	43	86	20	25	PT1/8	GCMT040204-U	TS2	TKY06F
	3	TAFM1450F20	●	2	47	57	100	20	25	PT1/8	GCMT040204-U	TS2	TKY06F
15.0	2	TAFS1500F20	●	2	35	45	88	20	25	PT1/8	GPMT060204-U	TS2	TKY06F
	3	TAFM1500F20	●	2	50	60	103	20	25	PT1/8	GPMT060204-U	TS2	TKY06F
15.5	2	TAFS1550F20	●	2	35	45	88	20	25	PT1/8	GPMT060204-U	TS2	TKY06F
	3	TAFM1550F20	●	2	50	60	103	20	25	PT1/8	GPMT060204-U	TS2	TKY06F
16.0	2	TAFS1600F25	●	2	38	57	107	25	35	PT1/8	GPMT060204-U	TS2	TKY06F
	3	TAFM1600F25	●	2	54	73	123	25	35	PT1/8	GPMT060204-U	TS2	TKY06F
	4	TAFM1600F25	●	2	70	89	139	25	35	PT1/8	GPMT060204-U	TS2	TKY06F
16.5	2	TAFS1650F25	●	2	38	57	107	25	35	PT1/8	GPMT060204-U	TS2	TKY06F
	3	TAFM1650F25	●	2	54	73	123	25	35	PT1/8	GPMT060204-U	TS2	TKY06F
17.0	2	TAFS1700F25	●	2	41	59	109	25	35	PT1/8	GPMT060204-U	TS2	TKY06F
	3	TAFM1700F25	●	2	58	76	126	25	35	PT1/8	GPMT060204-U	TS2	TKY06F
	4	TAFM1700F25	●	2	75	93	143	25	35	PT1/8	GPMT060204-U	TS2	TKY06F
17.5	2	TAFS1750F25	●	2	41	59	109	25	35	PT1/8	GPMT060204-U	TS2	TKY06F
	3	TAFM1750F25	●	2	58	76	126	25	35	PT1/8	GPMT060204-U	TS2	TKY06F
18.0	2	TAFS1800F25	●	2	43	61	111	25	35	PT1/8	GPMT070204-U	TS25	TKY08F
	3	TAFM1800F25	●	2	61	79	129	25	35	PT1/8	GPMT070204-U	TS25	TKY08F
	4	TAFM1800F25	●	2	79	97	147	25	35	PT1/8	GPMT070204-U	TS25	TKY08F
18.5	2	TAFS1850F25	●	2	43	61	111	25	35	PT1/8	GPMT070204-U	TS25	TKY08F
	3	TAFM1850F25	●	2	61	79	129	25	35	PT1/8	GPMT070204-U	TS25	TKY08F

钻头直径 D1 (mm)	钻削孔深 (l/d)	型号	库存	刃数	尺寸 (mm)						刀片型号		
					有效槽长	颈长	全长	柄径	刃长	供油孔			
					L3	L2	L1	D4	D7	D8			
19.0	2	TAFS1900F25	●	2	46	63	113	25	35	PT1/8	GPMT070204-U	TS25	①TKY08F
	3	TAFM1900F25	●	2	65	82	132	25	35	PT1/8	GPMT070204-U	TS25	①TKY08F
	4	T AFL1900F25	●	2	84	101	151	25	35	PT1/8	GPMT070204-U	TS25	①TKY08F
19.5	2	TAFS1950F25	●	2	46	63	113	25	35	PT1/8	GPMT070204-U	TS25	①TKY08F
	3	TAFM1950F25	●	2	65	82	132	25	35	PT1/8	GPMT070204-U	TS25	①TKY08F
20.0	2	TAFS2000F25	●	2	48	65	115	25	35	PT1/8	GPMT070204-U	TS25	①TKY08F
	3	TAFM2000F25	●	2	68	85	135	25	35	PT1/8	GPMT070204-U	TS25	①TKY08F
	4	T AFL2000F25	●	2	88	105	155	25	35	PT1/8	GPMT070204-U	TS25	①TKY08F
20.5	2	TAFS2050F25	●	2	48	65	115	25	35	PT1/8	GPMT070204-U	TS25	①TKY08F
	3	TAFM2050F25	●	2	68	85	135	25	35	PT1/8	GPMT070204-U	TS25	①TKY08F
21.0	2	TAFS2100F25	●	2	50	67	117	25	35	PT1/8	GPMT070204-U	TS25	①TKY08F
	3	TAFM2100F25	●	2	71	88	138	25	35	PT1/8	GPMT070204-U	TS25	①TKY08F
	4	T AFL2100F25	●	2	92	109	159	25	35	PT1/8	GPMT070204-U	TS25	①TKY08F
21.5	2	TAFS2150F25	●	2	50	67	117	25	35	PT1/8	GPMT070204-U	TS25	①TKY08F
	3	TAFM2150F25	●	2	71	88	138	25	35	PT1/8	GPMT070204-U	TS25	①TKY08F
22.0	2	TAFS2200F25	●	2	53	69	119	25	35	PT1/8	GPMT070204-U	TS25	①TKY08F
	3	TAFM2200F25	●	2	75	91	141	25	35	PT1/8	GPMT070204-U	TS25	①TKY08F
	4	T AFL2200F25	●	2	97	113	163	25	35	PT1/8	GPMT070204-U	TS25	①TKY08F
22.5	2	TAFS2250F25	●	2	53	69	119	25	35	PT1/8	GPMT070204-U	TS25	①TKY08F
	3	TAFM2250F25	●	2	75	91	141	25	35	PT1/8	GPMT070204-U	TS25	①TKY08F
23.0	2	TAFS2300F25	●	2	55	71	121	25	35	PT1/8	GPMT090304-U	TS3	①TKY08F
	3	TAFM2300F25	●	2	78	94	144	25	35	PT1/8	GPMT090304-U	TS3	①TKY08F
	4	T AFL2300F25	●	2	101	117	167	25	35	PT1/8	GPMT090304-U	TS3	①TKY08F
23.5	2	TAFS2350F25	●	2	55	71	121	25	35	PT1/8	GPMT090304-U	TS3	①TKY08F
	3	TAFM2350F25	●	2	78	94	144	25	35	PT1/8	GPMT090304-U	TS3	①TKY08F
24.0	2	TAFS2400F25	●	2	58	73	123	25	35	PT1/8	GPMT090304-U	TS3	①TKY08F
	3	TAFM2400F25	●	2	82	97	147	25	35	PT1/8	GPMT090304-U	TS3	①TKY08F
	4	T AFL2400F25	●	2	106	121	171	25	35	PT1/8	GPMT090304-U	TS3	①TKY08F
24.5	2	TAFS2450F25	●	2	58	73	123	25	35	PT1/8	GPMT090304-U	TS3	①TKY08F
	3	TAFM2450F25	●	2	82	97	147	25	35	PT1/8	GPMT090304-U	TS3	①TKY08F
25.0	2	TAFS2500F32	●	2	60	75	130	32	42	PT1/8	GPMT090304-U	TS3	①TKY08F
	3	TAFM2500F32	●	2	85	100	155	32	42	PT1/8	GPMT090304-U	TS3	①TKY08F
	4	T AFL2500F32	●	2	110	125	180	32	42	PT1/8	GPMT090304-U	TS3	①TKY08F
25.5	2	TAFS2550F32	●	2	60	75	130	32	42	PT1/8	GPMT090304-U	TS3	①TKY08F
	3	TAFM2550F32	●	2	85	100	155	32	42	PT1/8	GPMT090304-U	TS3	①TKY08F
26.0	2	TAFS2600F32	●	2	62	77	132	32	42	PT1/8	GPMT090304-U	TS3	①TKY08F
	3	TAFM2600F32	●	2	88	103	158	32	42	PT1/8	GPMT090304-U	TS3	①TKY08F
	4	T AFL2600F32	●	2	114	129	184	32	42	PT1/8	GPMT090304-U	TS3	①TKY08F
26.5	2	TAFS2650F32	●	2	62	77	132	32	42	PT1/8	GPMT090304-U	TS3	①TKY08F
	3	TAFM2650F32	●	2	88	103	158	32	42	PT1/8	GPMT090304-U	TS3	①TKY08F
27.0	2	TAFS2700F32	●	2	65	79	134	32	42	PT1/8	GPMT090304-U	TS3	①TKY08F
	3	TAFM2700F32	●	2	92	106	161	32	42	PT1/8	GPMT090304-U	TS3	①TKY08F
	4	T AFL2700F32	●	2	119	133	188	32	42	PT1/8	GPMT090304-U	TS3	①TKY08F
27.5	2	TAFS2750F32	●	2	65	79	134	32	42	PT1/8	GPMT090304-U	TS3	①TKY08F
	3	TAFM2750F32	●	2	92	106	161	32	42	PT1/8	GPMT090304-U	TS3	①TKY08F
28.0	2	TAFS2800F32	●	2	67	81	136	32	42	PT1/8	GPMT11T308-U	TS4	②TKY15D
	3	TAFM2800F32	●	2	95	109	164	32	42	PT1/8	GPMT11T308-U	TS4	②TKY15D
	4	T AFL2800F32	●	2	123	137	192	32	42	PT1/8	GPMT11T308-U	TS4	②TKY15D

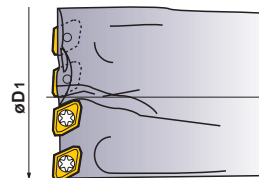
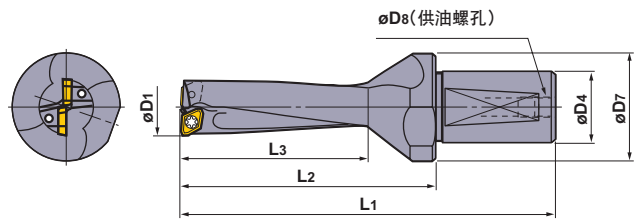
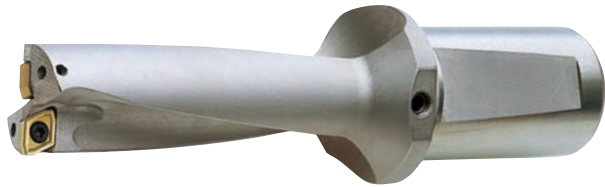

刃数为4刃时(φ49以上)

钻头直径 D1 (mm)	钻削孔深 (l/d)	型号	库存	刃数	尺寸 (mm)						刀片型号	夹紧螺钉	扳手
					有效槽长	颈长	全长	柄径	刀片直径	供油孔			
					L3	L2	L1	D4	D7	D8			
28.5	2	TAFS2850F32	●	2	67	81	136	32	42	PT1/8	GPMT11T308-U	TS4	TKY15D
	3	TAFM2850F32	●	2	95	109	164	32	42	PT1/8	GPMT11T308-U	TS4	TKY15D
29.0	2	TAFS2900F32	●	2	70	83	138	32	42	PT1/8	GPMT11T308-U	TS4	TKY15D
	3	TAFM2900F32	●	2	99	112	167	32	42	PT1/8	GPMT11T308-U	TS4	TKY15D
	4	TAFM2900F32	●	2	128	141	196	32	42	PT1/8	GPMT11T308-U	TS4	TKY15D
29.5	2	TAFS2950F32	●	2	70	83	138	32	42	PT1/8	GPMT11T308-U	TS4	TKY15D
	3	TAFM2950F32	●	2	99	112	167	32	42	PT1/8	GPMT11T308-U	TS4	TKY15D
30.0	2	TAFS3000F40	●	2	72	90	155	40	50	PT1/4	GPMT11T308-U	TS4	TKY15D
	3	TAFM3000F40	●	2	102	120	185	40	50	PT1/4	GPMT11T308-U	TS4	TKY15D
	4	TAFM3000F40	●	2	132	150	215	40	50	PT1/4	GPMT11T308-U	TS4	TKY15D
31.0	2	TAFS3100F40	●	2	74	92	157	40	50	PT1/4	GPMT11T308-U	TS4	TKY15D
	3	TAFM3100F40	●	2	105	123	188	40	50	PT1/4	GPMT11T308-U	TS4	TKY15D
	4	TAFM3100F40	●	2	136	154	219	40	50	PT1/4	GPMT11T308-U	TS4	TKY15D
32.0	2	TAFS3200F40	●	2	77	94	159	40	50	PT1/4	GPMT11T308-U	TS4	TKY15D
	3	TAFM3200F40	●	2	109	126	191	40	50	PT1/4	GPMT11T308-U	TS4	TKY15D
	4	TAFM3200F40	●	2	141	158	223	40	50	PT1/4	GPMT11T308-U	TS4	TKY15D
33.0	2	TAFS3300F40	●	2	79	96	161	40	50	PT1/4	GPMT11T308-U	TS4	TKY15D
	3	TAFM3300F40	●	2	112	129	194	40	50	PT1/4	GPMT11T308-U	TS4	TKY15D
	4	TAFM3300F40	●	2	145	162	227	40	50	PT1/4	GPMT11T308-U	TS4	TKY15D
34.0	2	TAFS3400F40	●	2	82	98	163	40	50	PT1/4	GPMT11T308-U	TS4	TKY15D
	3	TAFM3400F40	●	2	116	132	197	40	50	PT1/4	GPMT11T308-U	TS4	TKY15D
	4	TAFM3400F40	●	2	150	166	231	40	50	PT1/4	GPMT11T308-U	TS4	TKY15D
35.0	2	TAFS3500F40	●	2	84	100	165	40	50	PT1/4	GPMT140408-U	TS55	TKY25D
	3	TAFM3500F40	●	2	119	135	200	40	50	PT1/4	GPMT140408-U	TS55	TKY25D
36.0	2	TAFS3600F40	●	2	86	102	167	40	50	PT1/4	GPMT140408-U	TS55	TKY25D
	3	TAFM3600F40	●	2	122	138	203	40	50	PT1/4	GPMT140408-U	TS55	TKY25D
37.0	2	TAFS3700F40	●	2	89	104	169	40	50	PT1/4	GPMT140408-U	TS55	TKY25D
	3	TAFM3700F40	●	2	126	141	206	40	50	PT1/4	GPMT140408-U	TS55	TKY25D
38.0	2	TAFS3800F40	●	2	91	106	171	40	50	PT1/4	GPMT140408-U	TS55	TKY25D
	3	TAFM3800F40	●	2	129	144	209	40	50	PT1/4	GPMT140408-U	TS55	TKY25D
39.0	2	TAFS3900F40	●	2	94	108	173	40	50	PT1/4	GPMT140408-U	TS55	TKY25D
	3	TAFM3900F40	●	2	133	147	212	40	50	PT1/4	GPMT140408-U	TS55	TKY25D

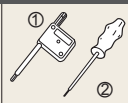
钻头直径 D1 (mm)	钻削孔深 (l/d)	型号	库存	刃数	尺寸 (mm)						刀片型号		
					有效槽长	颈长	全长	柄径	刃台直径	供油孔			
					L3	L2	L1	D4	D7	D8			
40.0	2	TAFS4000F40	●	2	96	110	175	40	50	PT1/4	GPMT140408-U [○]	TS55	②TKY25D
	3	TAFM4000F40	●	2	136	150	215	40	50	PT1/4	GPMT140408-U [○]	TS55	②TKY25D
41.0	2	TAFS4100F40	●	2	98	112	177	40	50	PT1/4	GPMT140408-U [○]	TS55	②TKY25D
	3	TAFM4100F40	●	2	139	153	218	40	50	PT1/4	GPMT140408-U [○]	TS55	②TKY25D
42.0	2	TAFS4200F40	●	2	101	114	179	40	50	PT1/4	GPMT140408-U [○]	TS55	②TKY25D
	3	TAFM4200F40	●	2	143	156	221	40	50	PT1/4	GPMT140408-U [○]	TS55	②TKY25D
43.0	2	TAFS4300F40	●	2	103	116	181	40	50	PT1/4	GPMT140408-U [○]	TS55	②TKY25D
	3	TAFM4300F40	●	2	146	159	224	40	50	PT1/4	GPMT140408-U [○]	TS55	②TKY25D
44.0	2	TAFS4400F40	●	2	106	118	183	40	50	PT1/4	GPMT140408-U [○]	TS55	②TKY25D
	3	TAFM4400F40	●	2	150	162	227	40	50	PT1/4	GPMT140408-U [○]	TS55	②TKY25D
45.0	2	TAFS4500F40	●	2	108	120	185	40	54	PT1/4	GPMT140408-U [○]	TS55	②TKY25D
	3	TAFM4500F40	●	2	153	165	230	40	54	PT1/4	GPMT140408-U [○]	TS55	②TKY25D
46.0	2	TAFS4600F40	●	2	110	122	187	40	54	PT1/4	GPMT140408-U [○]	TS55	②TKY25D
	3	TAFM4600F40	●	2	156	168	233	40	54	PT1/4	GPMT140408-U [○]	TS55	②TKY25D
47.0	2	TAFS4700F40	●	2	113	124	189	40	54	PT1/4	GPMT140408-U [○]	TS55	②TKY25D
	3	TAFM4700F40	●	2	160	171	236	40	54	PT1/4	GPMT140408-U [○]	TS55	②TKY25D
48.0	2	TAFS4800F40	●	2	115	126	191	40	54	PT1/4	GPMT140408-U [○]	TS55	②TKY25D
	3	TAFM4800F40	●	2	163	174	239	40	54	PT1/4	GPMT140408-U [○]	TS55	②TKY25D
49.0	2	TAFS4900F40	●	4	118	133	198	40	58	PT1/4	GPMT090304-U [○]	TS3	①TKY08F
	3	TAFM4900F40	●	4	167	182	247	40	58	PT1/4	GPMT090304-U [○]	TS3	①TKY08F
50.0	2	TAFS5000F40	●	4	120	135	200	40	58	PT1/4	GPMT090304-U [○]	TS3	①TKY08F
	3	TAFM5000F40	●	4	170	185	250	40	58	PT1/4	GPMT090304-U [○]	TS3	①TKY08F
51.0	2	TAFS5100F40	●	4	122	137	202	40	58	PT1/4	GPMT090304-U [○]	TS3	①TKY08F
	3	TAFM5100F40	●	4	173	188	253	40	58	PT1/4	GPMT090304-U [○]	TS3	①TKY08F
52.0	2	TAFS5200F40	●	4	125	139	204	40	58	PT1/4	GPMT090304-U [○]	TS3	①TKY08F
	3	TAFM5200F40	●	4	177	191	256	40	58	PT1/4	GPMT090304-U [○]	TS3	①TKY08F
53.0	2	TAFS5300F40	●	4	127	141	206	40	63	PT1/4	GPMT090304-U [○]	TS3	①TKY08F
	3	TAFM5300F40	●	4	180	194	259	40	63	PT1/4	GPMT090304-U [○]	TS3	①TKY08F
54.0	2	TAFS5400F40	●	4	128	143	208	40	63	PT1/4	GPMT090304-U [○]	TS3	①TKY08F
	3	TAFM5400F40	●	4	182	197	262	40	63	PT1/4	GPMT090304-U [○]	TS3	①TKY08F
55.0	2	TAFS5500F40	●	4	130	145	210	40	63	PT1/4	GPMT090304-U [○]	TS3	①TKY08F
	3	TAFM5500F40	●	4	185	200	265	40	63	PT1/4	GPMT090304-U [○]	TS3	①TKY08F
56.0	2	TAFS5600F40	●	4	132	147	212	40	63	PT1/4	GPMT090304-U [○]	TS3	①TKY08F
	3	TAFM5600F40	●	4	188	203	268	40	63	PT1/4	GPMT090304-U [○]	TS3	①TKY08F

刀片规格

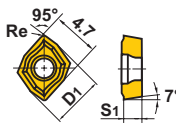
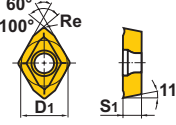
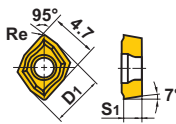
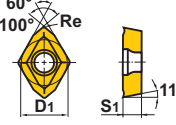
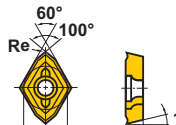
形状	对应钻头直径	刀片型号	尺寸 (mm)			库存材料					
			D1	S1	Re	NEW VP15TF	UP20M	GP20M	UE6020	US735	F5010
U1断屑槽 GCMT  GPMT 	φ12—φ14.5	GCMT040204-U1	5.0	2.38	0.4		●				
	φ15—φ17.5	GPMT060204-U1	5.56	2.38	0.4		●		●	●	●
	φ18—φ22.5	GPMT070204-U1	6.35	2.38	0.4		●		●	●	●
	φ23—φ27.5	GPMT090304-U1	7.94	3.18	0.4		●		●	●	●
	φ49—φ56										
	φ28—φ34	GPMT11T308-U1	9.525	3.97	0.8		●		●	●	●
	φ35—φ48	GPMT140408-U1	12.70	4.76	0.8		●		●	●	●
U2断屑槽 GCMT  GPMT 	φ12—φ14.5	GCMT040204-U2	5.0	2.38	0.4	●		●			
	φ15—φ17.5	GPMT060204-U2	5.56	2.38	0.4	●	●		●	●	●
	φ18—φ22.5	GPMT070204-U2	6.35	2.38	0.4	●	●		●	●	●
	φ23—φ27.5	GPMT090304-U2	7.94	3.18	0.4	●	●		●	●	●
	φ49—φ56										
	φ28—φ34	GPMT11T308-U2	9.525	3.97	0.8	●	●		●	●	●
	φ35—φ48	GPMT140408-U2	12.70	4.76	0.8	●	●		●	●	●
U3断屑槽 GPMT 	φ15—φ17.5	GPMT060204-U3	5.56	2.38	0.4		●		●	●	●
	φ18—φ22.5	GPMT070204-U3	6.35	2.38	0.4		●		●	●	●
	φ23—φ27.5	GPMT090304-U3	7.94	3.18	0.4		●		●	●	●
	φ49—φ56										
	φ28—φ34	GPMT11T308-U3	9.525	3.97	0.8		●		●	●	●
	φ35—φ48	GPMT140408-U3	12.70	4.76	0.8		●		●	●	●

刀片使用分类

刀片断屑槽的适用范围

◎：第一推荐 ○：第二推荐

工件材料	P						M		K			
	软钢		碳钢		合金钢		不锈钢		铸铁		球墨铸铁	
	GCMT	GPMT	GCMT	GPMT	GCMT	GPMT	GCMT	GPMT	GCMT	GPMT	GCMT	GPMT
U1	◎	◎	○	○	○	○	○	○	○	○	○	○
U2	○	○	◎	○	◎	○	◎	◎	◎	○	◎	○
U3		○		◎		◎		○		◎		◎

刀片材料的适用范围

◎：第一推荐 ○：第二推荐

材料	P						M		K			
	软钢		碳钢		合金钢		不锈钢		铸铁		球墨铸铁	
	GCMT	GPMT	GCMT	GPMT	GCMT	GPMT	GCMT	GPMT	GCMT	GPMT	GCMT	GPMT
NEW VP15TF	○	○	◎	○	◎	○	◎	◎	◎	○	◎	○
UP20M	◎	◎	○	○	○	○	○	○	○	○	○	◎
GP20M	○		◎		◎		◎		◎		◎	
UE6020		○		◎		◎		○		○		○
US735		○		○		○		◎		○		○
F5010										◎		◎

推荐切削条件

工件材料	硬度	切削速度 (m/min)			断屑槽	每转进给量 (mm/rev)					
		l/d=2, 3用		l/d=4用 (φ16-)		钻头直径 (mm)					
		(φ12-φ14.5)	(φ15-)			φ12-φ14.5	φ15-φ22.5	φ23-φ34	φ35-φ48	φ49-φ56	
P 软钢 (SS400等)	≤HB180	150 (100-200)	200 (150-300)	140 (100-200)	U1	0.06 (0.04-0.10)	0.07 (0.04-0.10)	0.08 (0.04-0.10)	0.10 (0.04-0.12)	0.08 (0.04-0.10)	
					U2	0.06 (0.04-0.10)	0.08 (0.04-0.12)	0.10 (0.04-0.12)	0.12 (0.04-0.14)	0.10 (0.04-0.12)	
					U3	—	0.08 (0.04-0.12)	0.10 (0.04-0.12)	0.12 (0.04-0.14)	0.10 (0.04-0.12)	
	碳钢 (S45C, S48C等)	HB180-280	120 (80-160)	150 (120-180)	100 (80-120)	U1	0.06 (0.04-0.10)	0.09 (0.06-0.12)	0.12 (0.08-0.14)	0.15 (0.08-0.18)	0.12 (0.08-0.14)
						U2	0.06 (0.04-0.10)	0.12 (0.06-0.14)	0.14 (0.08-0.18)	0.17 (0.08-0.20)	0.14 (0.08-0.18)
						U3	—	0.12 (0.06-0.14)	0.14 (0.08-0.18)	0.17 (0.08-0.20)	0.14 (0.08-0.18)
	合金钢 (SCM440, SCr420等)	HB180-280	120 (80-160)	150 (120-180)	100 (80-120)	U1	0.06 (0.04-0.10)	0.08 (0.06-0.10)	0.09 (0.06-0.12)	0.11 (0.06-0.14)	0.09 (0.06-0.12)
						U2	0.06 (0.04-0.10)	0.10 (0.06-0.12)	0.12 (0.08-0.16)	0.14 (0.08-0.18)	0.12 (0.08-0.16)
						U3	—	0.10 (0.06-0.12)	0.12 (0.08-0.16)	0.14 (0.08-0.18)	0.12 (0.08-0.16)
M 不锈钢 (SUS304, SUS316等)	≤HB200	100 (80-120)	150 (120-200)	110 (80-140)	U1	0.07 (0.04-0.10)	0.07 (0.04-0.10)	0.08 (0.04-0.10)	0.10 (0.04-0.12)	0.08 (0.04-0.10)	
					U2	0.07 (0.04-0.10)	0.08 (0.04-0.12)	0.10 (0.04-0.14)	0.12 (0.04-0.16)	0.10 (0.04-0.14)	
					U3	—	0.08 (0.04-0.12)	0.10 (0.04-0.14)	0.12 (0.04-0.16)	0.10 (0.04-0.14)	
K 铸铁 (FC250等)	抗拉强度 ≤350MPa	120 (80-160)	150 (120-180)	140 (110-160)	U1	0.07 (0.06-0.10)	0.07 (0.06-0.10)	0.10 (0.04-0.14)	0.10 (0.06-0.14)	0.10 (0.06-0.14)	
					U2	0.07 (0.06-0.10)	0.15 (0.10-0.18)	0.20 (0.10-0.25)	0.20 (0.10-0.25)	0.20 (0.10-0.25)	
					U3	—	0.15 (0.10-0.18)	0.20 (0.10-0.25)	0.20 (0.10-0.25)	0.20 (0.10-0.25)	
球墨铸铁 (FCD400等)	抗拉强度 ≤450MPa	120 (80-150)	150 (120-180)	100 (80-120)	U1	0.06 (0.04-0.10)	0.07 (0.06-0.10)	0.10 (0.06-0.14)	0.10 (0.06-0.14)	0.10 (0.06-0.14)	
					U2	0.06 (0.04-0.10)	0.12 (0.08-0.14)	0.15 (0.08-0.20)	0.18 (0.08-0.20)	0.15 (0.08-0.20)	
					U3	—	0.12 (0.08-0.14)	0.15 (0.08-0.20)	0.18 (0.08-0.20)	0.15 (0.08-0.20)	

注：当选用l/d=4 钻头时，实际每转进给量应是上表推荐值的80%。

使用方法

● 斜面切入孔加工

工件材料：SCM440(HB 180—HB 280)
 钻头直径：φ20(3D用)、切削速度：80m/min
 每转进给量：0.08mm/rev

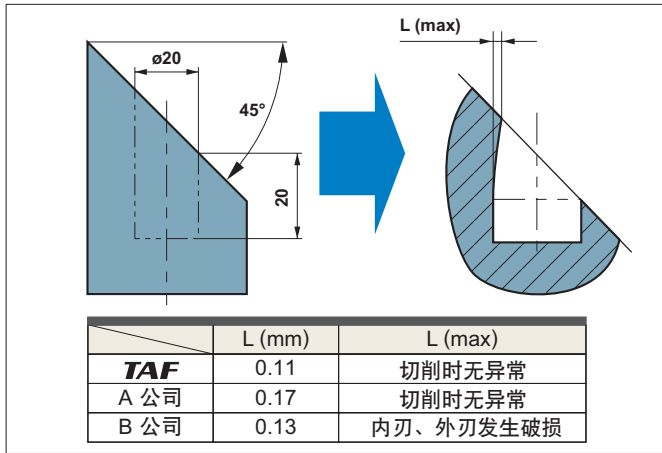

● 圆形材料孔加工

工件材料：SCM440(HB 180—HB 280)
 钻头直径：φ20(3D用)、切削速度：50, 80, 100m/min
 每转进给量：0.08mm/rev(切入时：0.05mm/rev)

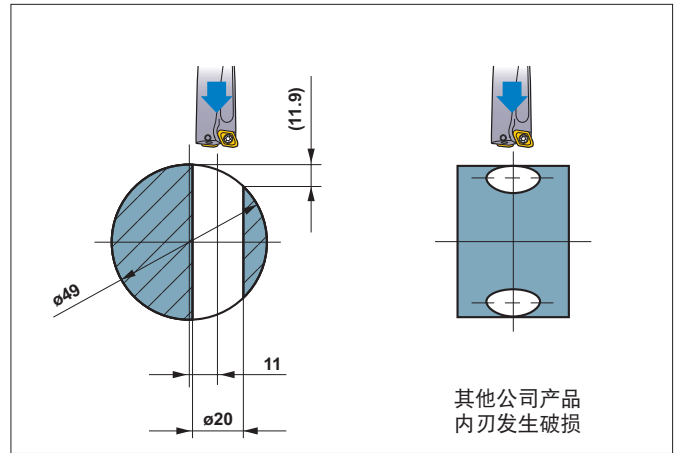

● 工件单边固定的孔加工

工件材料：S50C(HB 120—HB 180)、钻头直径：φ20(3D用)、切削速度：80m/min、每转进给量：0.08mm/rev

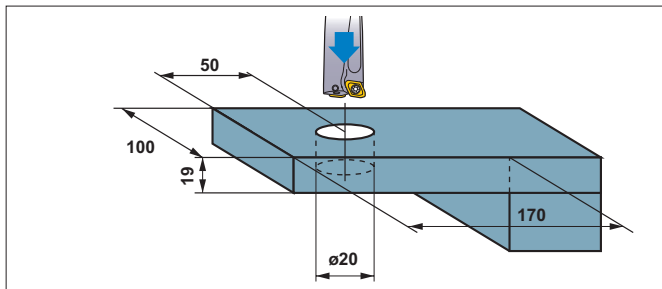

● 扩大量(与钻头的实测直径相比)

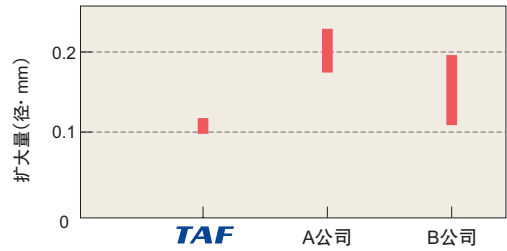

● 请使用刚性良好的机床和刀柄夹头。

● 切削液的工作压力与流量以下图为准。
 切削液是发挥钻头性能的重要条件。

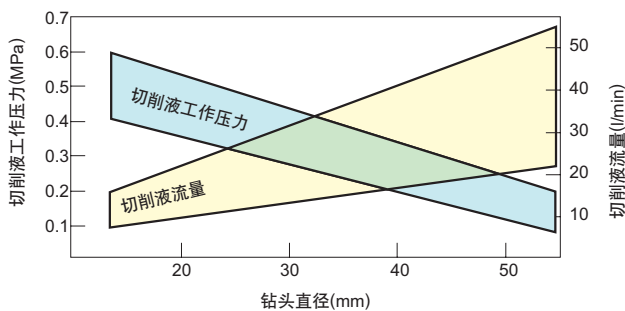

● 不能加工叠板。
 可转位钻头钻通孔时,会产生圆盘状切屑。
 加工叠板时产生的圆盘状切屑会损伤钻头。

● 使用车床时

(1) 内刃高于主轴中心
 0-0.2mm。

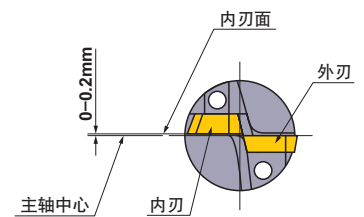

(2) 要调整孔径时因为要偏置,外刃请调整到与刀架倾斜面(机床X轴)平行。

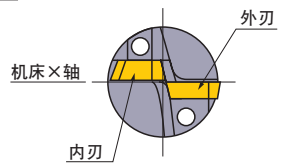

(3) 孔径扩大所调整的偏置量应小于选用钻头直径的2%,此外,孔径不能调小。

(4) 在车床上钻削通孔时,钻通时生成的圆盘状切屑常常会飞出。在没有外罩的普通车床加工时为防止危险,请安装防护罩。

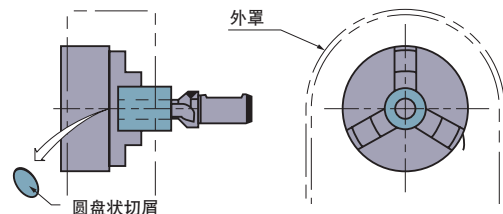

增径专用滑套

使用增径专用滑套,能以0.1mm为间隔,使直径增加0.1、0.2、0.3、0.4、0.5mm。

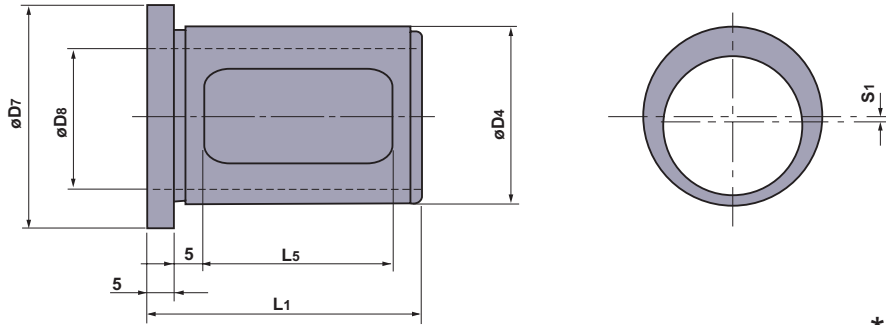

* 增径：钻头直径的增大量

整套型号	单件型号	库存	尺寸 (mm)					*增径 (S1 x 2)	适用TAF钻头
			D7	D4	D8	L1	L5		
JFS-1	JFS2520-10	●	33	25	20	43	30	0.10	TAFS/M/L1200F20 TAFS/M/L1550F20
	2520-20	●	33	25	20	43	30	0.20	
	2520-30	●	33	25	20	43	30	0.30	
	2520-40	●	33	25	20	43	30	0.40	
	2520-50	●	33	25	20	43	30	0.50	
JFS-2	JFS3225-10	●	40	32	25	50	34	0.10	TAFS/M/L1600F25 TAFS/M/L2450F25
	3225-20	●	40	32	25	50	34	0.20	
	3225-30	●	40	32	25	50	34	0.30	
	3225-40	●	40	32	25	50	34	0.40	
	3225-50	●	40	32	25	50	34	0.50	
JFS-3	JFS4032-10	●	48	40	32	55	40	0.10	TAFS/M/L2500F32 TAFS/M/L2950F32
	4032-20	●	48	40	32	55	40	0.20	
	4032-30	●	48	40	32	55	40	0.30	
	4032-40	●	48	40	32	55	40	0.40	
	4032-50	●	48	40	32	55	40	0.50	

●：标准库存品

专用滑套选择方法

被加工零件孔径 = (钻头直径 + 专用滑套增径) + 0.1

(例)加工 $\phi 20.3$ 孔(设扩大量为0.1)

$$\phi 20.3 = (\text{TAFS/M/L2000F25} + \text{JFS3225-20}) + 0.1$$

公称直径 $\phi 20$ 的钻头

专用滑套增径0.20 扩大量

<选用刀具>

钻头：TAFM2000F25

增径专用滑套

：JFS3225-20

(注)扩大量应随切削条件的不同而变化。上表的选定标准是标准值。

增径专用滑套的使用方法

1 插入侧锁紧刀柄时,应使钻头刀头凸盘外圆面上的V型槽与滑套外圆面上的圆孔并与侧锁紧刀柄上固定钻头的螺钉位置相一致(有的钻头无V型槽时,可使钻头刀柄部位削扁平面与滑套上的圆孔相垂直)。

2 侧锁紧刀柄上固定钻头用螺钉A,直接从滑套开口窗压紧钻头。

<注意>

- 滑套的直径不能微调。
- 不能使用在弹簧筒夹式刀柄上。



专用滑套的购买方法

●方法1 根据切削条件变化而使扩大量改变,推荐整套购买。整套(一套5件)购买请注明整套型号。

●方法2 也可单件购买。购买时请注明单件型号。

使用例

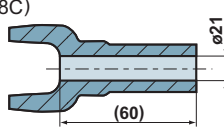
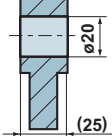
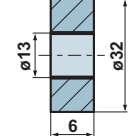
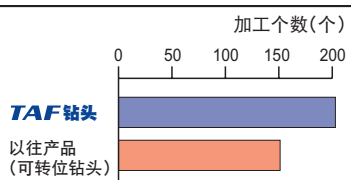
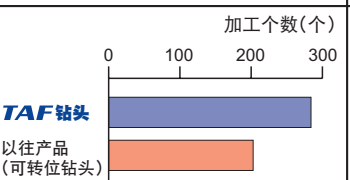
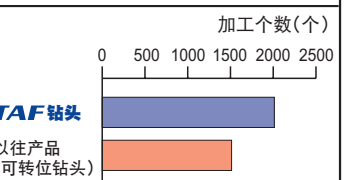
使用刀具	TAFM2100F25	TAFS2000F25	TAFS1300F20	
使用刀片(材料)	GPMT070204-U2 (VP15TF)	GPMT070204-U2 (VP15TF)	GCMT040204-U2 (GP20M)	
使用机床	NC数控车床	卧式加工中心机	NC数控车床	
工件	碳钢(S48C) 	碳钢(S30C) 	碳钢(S45C) 	
切削条件	切削速度 (m/min)	133	90	102
	每转进给量 (mm/rev)	0.12	0.21	0.10
	转速 (min ⁻¹)	2016	1432	2500
	进给速度 (mm/min)	242	301	250
切削液	水溶性	水溶性	油性	
结果				

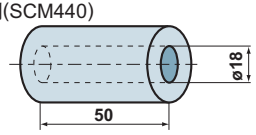
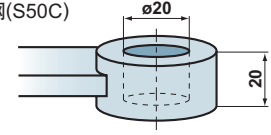
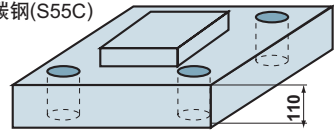
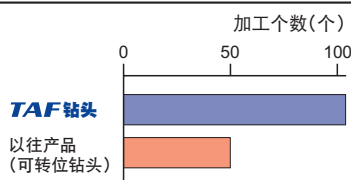
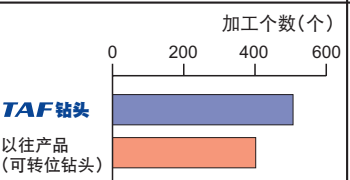
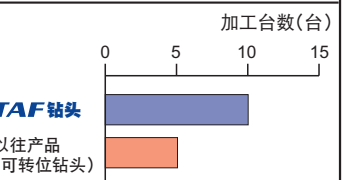
使用刀具	TAFM1800F25	TAFM2000F25	TAF12800F32	
使用刀片(材料)	GPMT070204-U2 (UE6020)	GPMT070204-U2 (UP20M)	GPMT11T308-U3 (UP20M)	
使用机床	NC数控车床	立式加工中心机	立式加工中心机	
工件	合金钢(SCM440) 	碳钢(S50C) 	碳钢(S55C) 	
切削条件	切削速度 (m/min)	150	95	106
	每转进给量 (mm/rev)	0.1	0.08	0.125
	转速 (min ⁻¹)	2653	1512	1205
	进给速度 (mm/min)	265	121	151
切削液	水溶性	水溶性	水溶性	
结果				

关于安全

- 请不要直接用手摸切削刃、切屑。● 请在推荐条件范围内使用，提早更换刀具。● 有时会有高温的切屑飞出、伸长的切屑推出。请使用安全罩、防护镜等防护用具。● 使用非水溶性切削液时，务必采取防火措施。
- 安装刀片或零部件时，请使用附带的扳手稳妥安装。● 使用旋转刀具时，务必进行试运转，确认有无共振、振动、异常声音。

三菱综合材料株式会社
MITSUBISHI MATERIALS CORPORATION

东亚销售部门：

〒130-0015 日本国东京都墨田区横网1-6-1, KFC大楼8楼

电话：81-3-5819-8771 传真：81-3-5819-8774

<http://www.mitsubishicarbide.com>

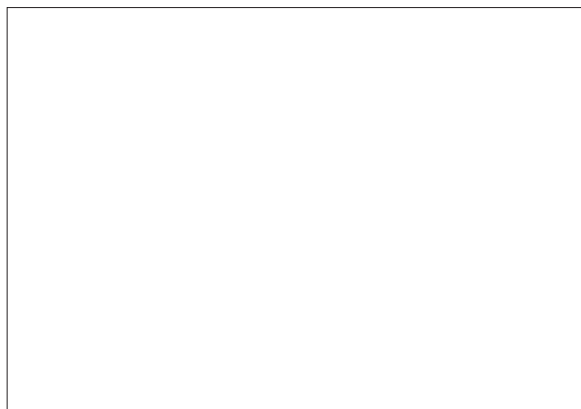

(规格若有更改，恕不事先通知)

