

PRODUCT NEWS

2024-1

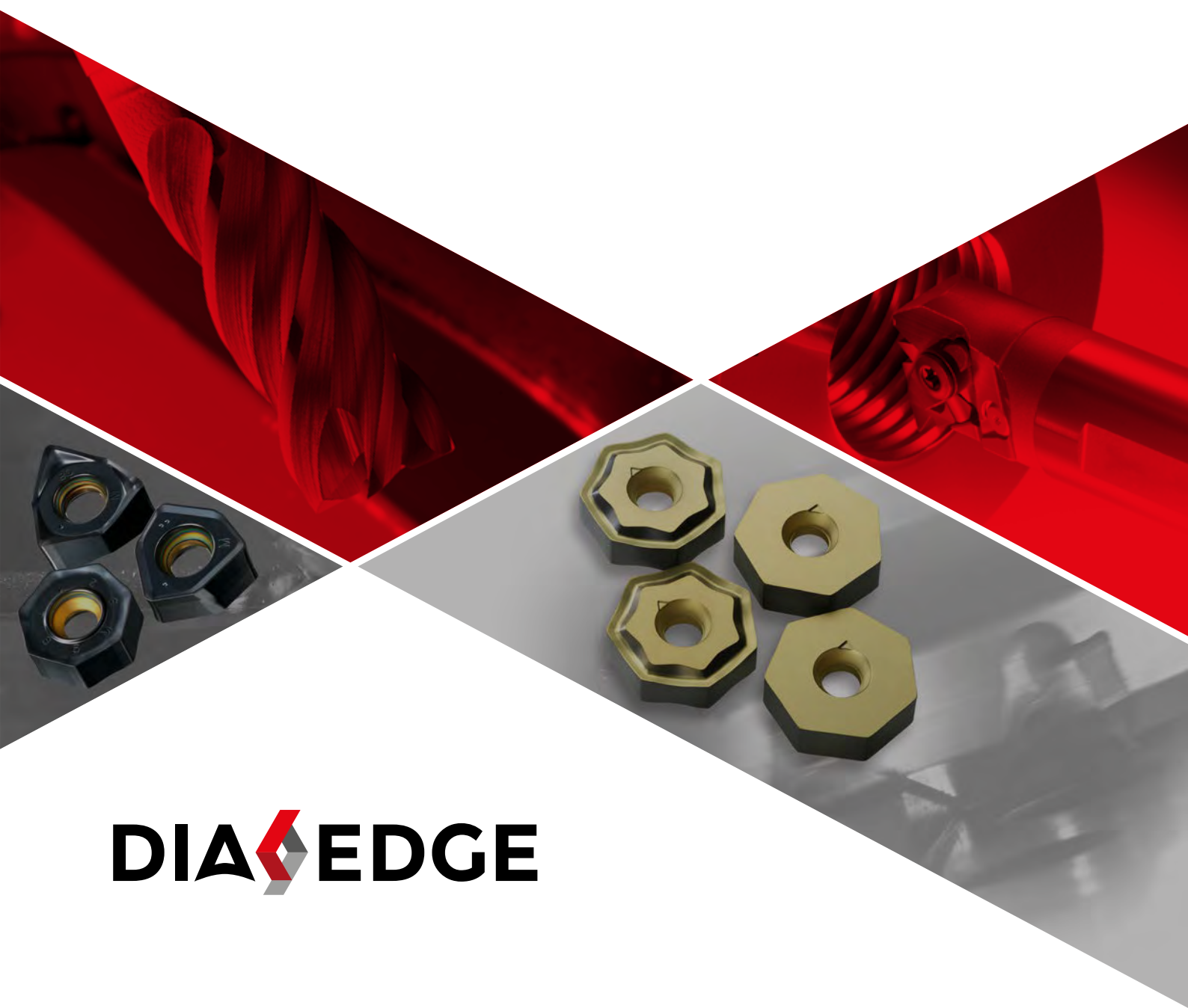

DIA EDGE



 MITSUBISHI MATERIALS

NEW CATALOGUE SYSTEM

HOW TO REPLACE PRODUCT NEWS BOOKS

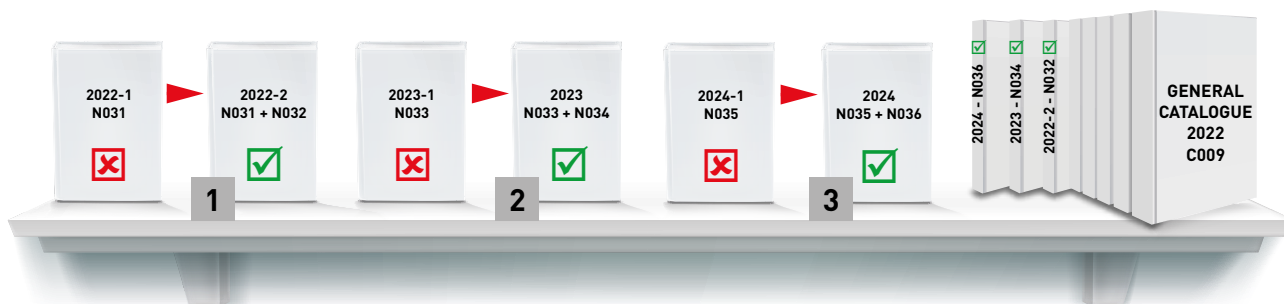

NOTES:

- 1 The Product News 2022-1 – N031 has been integrated into Product News 2022-2 – N032.
- 2 The Product News 2023-1 – N033 will be integrated into Product News 2023 – N034.
- 3 The Product News 2024-1 – N035 will be integrated into Product News 2024 – N036.

The yearly Product News catalogues (e.g. N032, N034 etc.) will complement the existing GENERAL CATALOGUE.

The Product News book ending with -1, can be disposed of after the publishing of the yearly Product News book.

TRANSITION FROM THE EXISTING TO THE NEW GENERAL CATALOGUE



NOTES:

The yearly Product News catalogues (e.g. N032, N034 etc.) will merge into the new GENERAL CATALOGUE.



NEW

PRODUCT NEWS 2024-1

NEW PRODUCTS AND SERIES EXPANSIONS AT A GLANCE

Mitsubishi Materials is consistently focusing on specific customer needs to better meet the challenges of the modern metal working industry. This catalogue shows all the new products and series expansions of the tooling brand DIAEDGE for turning, milling and drilling applications.

CURRENT, INNOVATIVE, COMPETITIVE





NOTES: This Product News 2024-1 (N035) complements the General Catalogue C009, Product News 2022-2 (N032) and the Product News 2023 (N034).

It contains all new products and series expansions that have been launched after the release of the N032, N034 book and the C009 catalogue.





We reserve the right to make changes to any item compared to the information and illustrations shown in this catalogue, e.g. with regard to technical data, construction, equipment provided, material and external appearance. All dimensions are in millimetres. You will find the latest version of this catalogue on our website: www.mmc-carbide.com

INDEX



TURNING TOOLS

NEW	MV9005	7
2023.10	New CVD coated grade exceeds all current standards when machining heat resistant super alloys.	
NEW	MMT THREADING SERIES	21
2024-1	AG-type is added to the accurate M-class type 3-D chipbreaker. MP9025 grade now available. Expansion of the VP15TF and VP20RT range.	
	MC6100 SERIES	
2023	Expansion of positive ISO turning insert series for various applications ranging from MC6115 for high speed machining through to MC6125 for general applications.	
	GY	
2023	GY monoblock holder expansion for precision machining of small parts.	
2022-2	1.2 mm GY insert and monoblock holder for precision machining of small parts. 1.5 mm/2.0 mm/2.5 mm/3.0 mm GY inserts with 8° & 15° lead angles.	
	MP/MT9000	
2023	ISO turning inserts for difficult-to-cut materials. Expansion of precision negative ISO turning insert series with FS & LS chipbreakers.	
	MP/MT9000	
2022-1	ISO turning inserts for difficult-to-cut materials. MP9025 PVD grade, 7° positive insert expansion for ISO-S turning.	
	MS7025/ MS9025	
2023	Expansion of the positive ISO turning insert series for small parts machining.	
	MS7025	
2022-2	PVD grade for high precision and stainless steel small parts machining.	
	MC5100 SERIES	
2023-1	CVD coated grades for machining cast iron. Ideal for high speed through to interrupted cutting.	
	BC8220	
2022-1	PCBN grade for general turning of hardened steels. New BR chipbreaker for excellent chip control when finishing, removing carburized layers, high load machining and hard-soft machining up to 1 mm depth of cut.	
	GW MONOBLOCKHOLDER	
2022-1	GW system expansion with monoblock holder and 2.39 mm width inserts. Different chipbreakers with 5° and 8° leads now available.	

SOLID MILLING TOOLS

NEW	VQ SERIES	37
2024-1	VQ4MVM – Maximum tool usage. One tool combines ramping, grooving, roughing and finishing and enables a new level of performance.	
	VFR	
2023	VFR4MB – Highly efficient finish machining of high hardened materials.	
	VFR	
2022-1	Expansion of VFR2XLB – Ideal for finishing deep pocket applications.	
	MP SERIES	
2023-1	MP3C – For highly efficient chamfer machining, also providing a long tool life.	
	VQ SERIES	
2022-2	VQJCS/VQLCS – New end mill with irregular pitch, chipbreaker flute geometry.	
2022-1	VQN4/6MVRB – Corner radius end mills to machine Ni-based alloys.	
	iMX	
2022-2	iMX-C6HV-C – Corner radius type with central coolant hole, 6 flute, irregular helix.	

INDEXABLE MILLING TOOLS

NEW	MV1000 SERIES	45
2023.10	Setting a new standard for tool life.	
NEW	AHX SERIES	72
2024-1	New chipbreaker system with XC5010.	
NEW	MX3030	109
2024-1	New cermet grade for a wider range of applications.	
	FMAX	
2023	FMAX-MB – Coarse pitch cutter bodies for highly efficient small parts machining and low rigidity machining conditions.	
	WWX SERIES	
2023	WWX200 – Insert range expansion with an L-type chipbreaker.	
2023-1	WWX200 – A new level of versatility. High performance 90° face milling cutter with new smaller size 09, double-sided trigon inserts. WWX400 – Insert range expansion with an M-type chipbreaker. Including large corner radii (RE 1.6/2.0 mm) and also with new wiper type inserts.	
	AXD	
2023-1	AXD4000 – New screw-in type for high speed machining of aluminium and titanium alloys.	

WSF406W

- 2022-2 New M-type chipbreaker and wiper insert.
 2022-1 Double sided insert with positive geometry for low cutting resistance.
 For high efficiency machining of cast iron.

**AJX**

- 2022-1 New arbor type with ultra fine pitch.
 Expansion of the multi-functional milling range.



DRILLING TOOLS

DFAS

- 2023 Solid carbide flat bottom drills.
 High efficiency drilling of a variety of applications.

**DSAS**

- 2022-2 New sizes added to the solid carbide drill series with internal coolant holes for HRSA materials.

**MINI DVAS**

- 2022-2 Solid carbide TRISTAR drill series.
 Fast, reliable and accurate.



MPLUS TOOLS

415SD

- 2023 First choice for high feed machining of titanium alloys.



NEW

MV9005

CVD-COATED GRADES EXCEED ALL CURRENT
STANDARDS WHEN MACHINING HEAT RESISTANT
SUPER ALLOYS

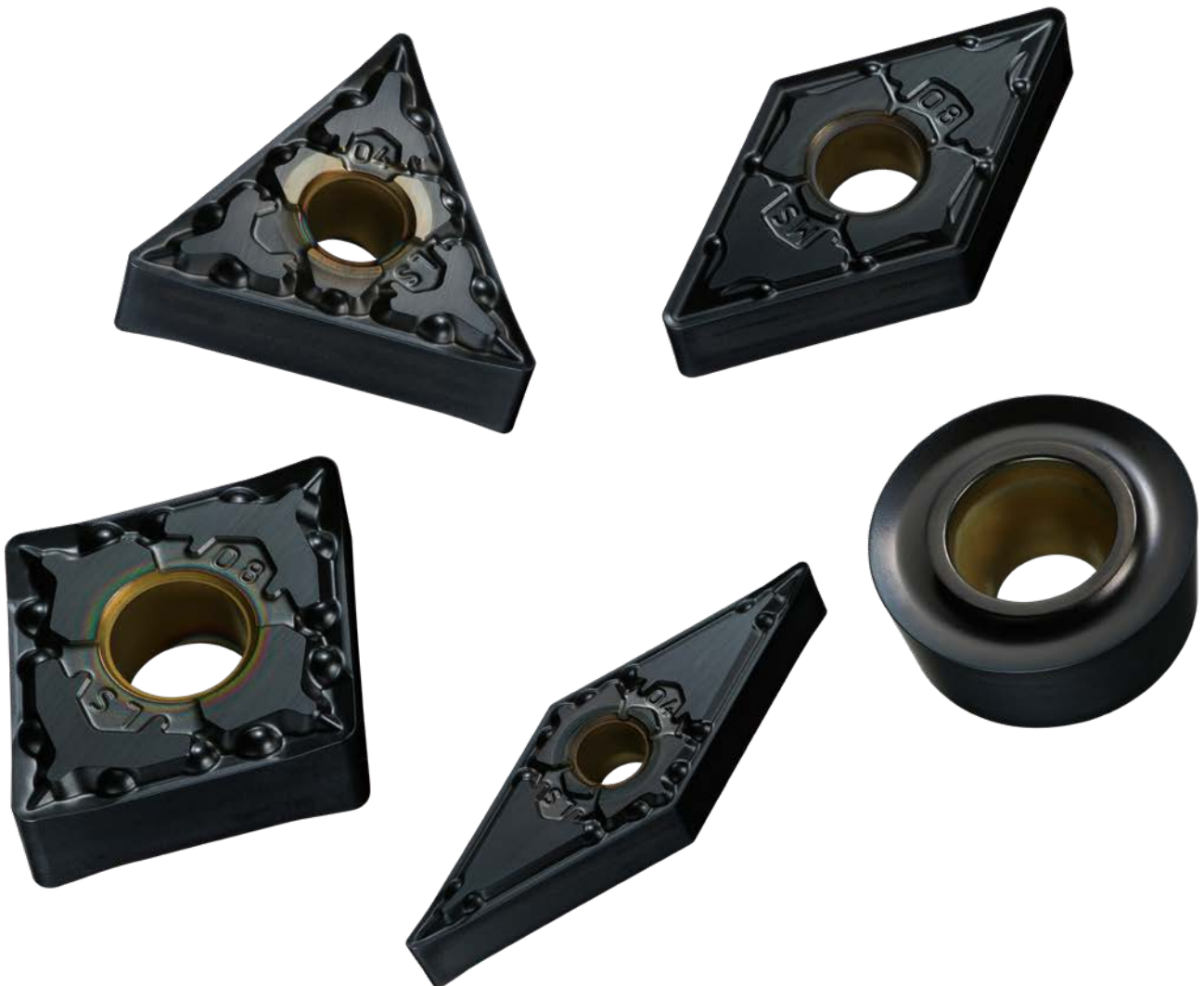

Interested in more...

B271

www.mhg-mediastore.net



MV9005

CVD-COATED GRADES EXCEED ALL CURRENT STANDARDS WHEN MACHINING HEAT RESISTANT SUPER ALLOYS

ADVANCED WEAR RESISTANCE

By adopting a newly developed Al-Rich coating technology, an (Al,Ti)N coating with a high Al content ratio for extreme hardness means that oxidation resistance is greatly improved, resulting in excellent wear resistance.

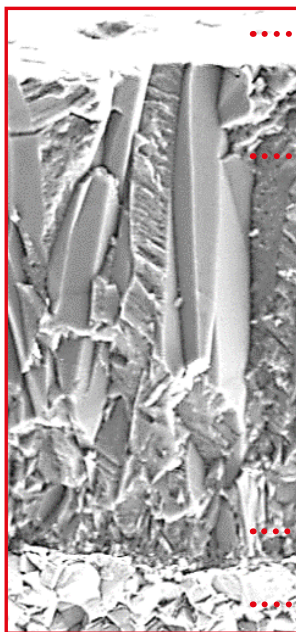

EXCELLENT WELDING RESISTANCE

Smooth surface.

OUTSTANDING WEAR RESISTANCE

Newly developed Al-Rich coating.

EXCELLENT CHIPPING RESISTANCE FOR STABLE MACHINING

Newly developed bonding layer.

EXCELLENT RESISTANCE TO PLASTIC DEFORMATION

Extremely hard dedicated cemented carbide substrate.

Graphical representation



MV9005

CVD-COATED GRADES EXCEED ALL CURRENT STANDARDS WHEN MACHINING HEAT RESISTANT SUPER ALLOYS

COMPLETE COATING TECHNOLOGY THAT TOPPLES CURRENT TOOL LIFE STANDARDS

Due to the newly developed Al-Rich coating.

Aluminium titanium nitride [Al,Ti]N is a compound of aluminium and titanium that is widely used as a coating for cutting tools due to its extremely hard and heat-resistant properties.

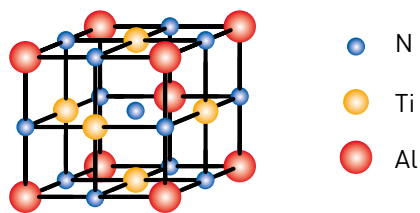

The combination of atoms with different sizes creates an exceptionally hard crystal structure.

The hardness of [Al,Ti]N increases as the Al content ratio increases, but with conventional technology, when the Al content ratio exceeds 60 %, the crystal structure changes and the hardness of [Al,Ti]N decreases.

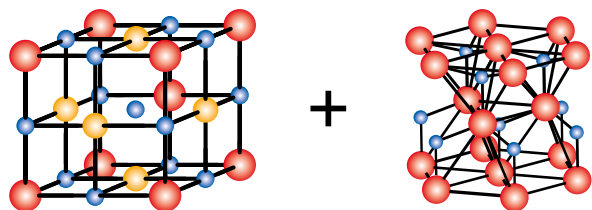

When the Al ratio is over 60 %, a softer crystal phase is formed.

Using a new coating process based on Mitsubishi Materials' own original technology, a way in which an Al-Rich coating does not change its crystal structure even when the Al content is increased was developed. This also achieves a higher Al content and a higher hardness of [Al,Ti]N.

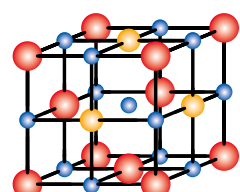
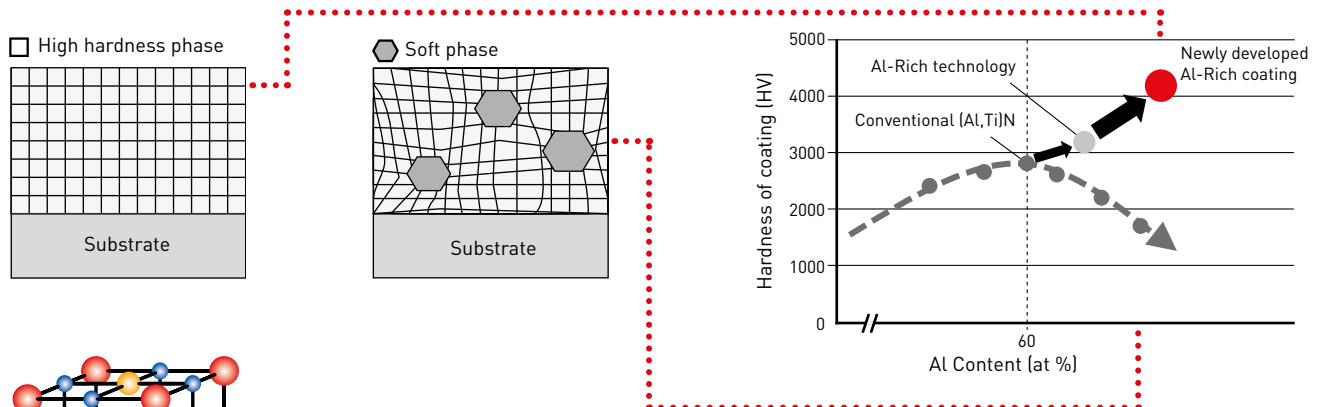



Crystal image of MV9005

MV9005

CHIPBREAKER SYSTEM

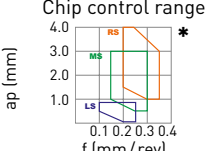
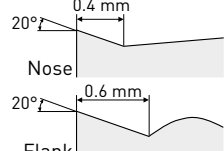
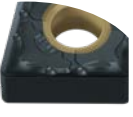
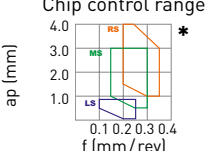
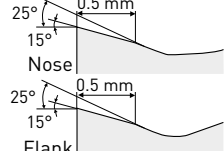
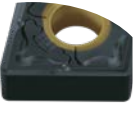
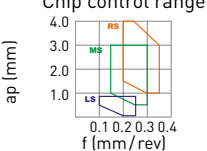
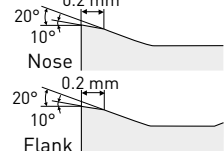
NEGATIVE INSERTS

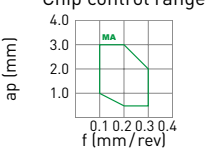
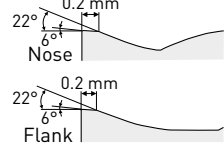
Tolerance	Features		Cross section geometry	
M	LIGHT CUTTING			
		Enhanced chip disposal for depths of cut smaller than the corner R.		
	LS			
	MEDIUM CUTTING			
		The large 2-step rake angle generates chips smoothly and without tangling during low feed cutting.		
MS				
ROUGH CUTTING				
	During low speed cutting the positive land controls chip welding and abrasion at the depth of cut line.			
RS				
MULTI-ASSIST CHIPBREAKER				
	Suitable for a medium cutting range.			
MA				

* The chipbreaker control range was tested for optimum chip evacuation when cutting Inconel®718 with a CNMG120408 insert.

POSITIVE INSERTS

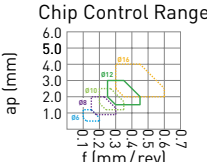
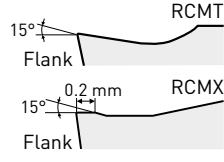
Tolerance	Features		Cross section geometry
M	MEDIUM CUTTING		
	Balance of strength and sharpness due to a combination of a flat land and rake angle.		

MV9005

CUTTING PERFORMANCE

COMPARISON OF WEAR RESISTANCE WHEN MACHINING INCONEL®718

Exhibits excellent wear resistance and extended tool life.

Material	Inconel®718
Insert	CNMG120412-00
Vc (m/min)	100
f (mm/rev)	0.3
ap (mm)	0.75
Cutting mode	Wet cutting

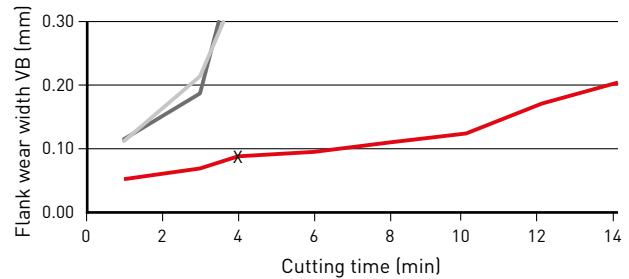

TAKEN AFTER MACHINING 4 MINUTES

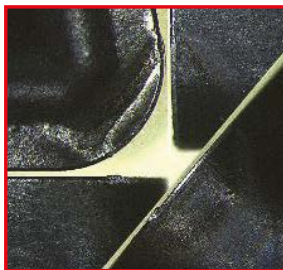

MV9005
MS Breaker



Conventional A

COMPARISON OF WEAR RESISTANCE WHEN MACHINING INCONEL®718

Demonstrates excellent wear resistance even during high-speed cutting of heat resistant alloys, thus improving machining efficiency.

Material	Inconel®718
Insert	CNMG120412-00
Vc (m/min)	150
f (mm/rev)	0.3
ap (mm)	0.75
Cutting mode	Wet cutting

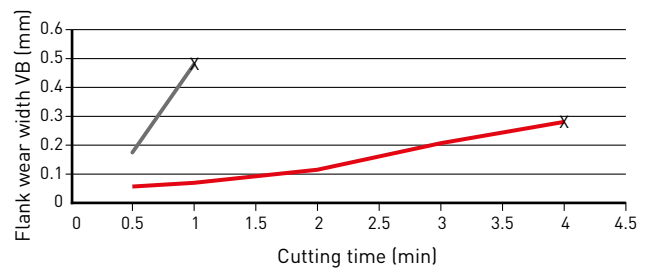

4 MIN. MACHINING



MV9005
MS Breaker

1 MIN. MACHINING

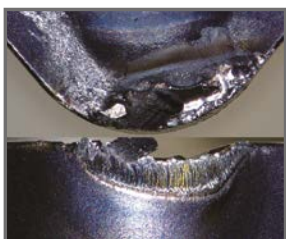

Conventional A

MV9005

CUTTING PERFORMANCE

COMPARISON OF WEAR RESISTANCE WHEN MACHINING RENE 41

Exhibits excellent wear resistance even when machining heat resistant alloy components that are used in high temperature environments of 800 °C or higher.

Material	Rene 41 (Ni based heat resistant alloys)
Insert	CNMG120412-
Vc (m/min)	30
f (mm/rev)	0.1
ap (mm)	0.5
Cutting mode	Wet cutting

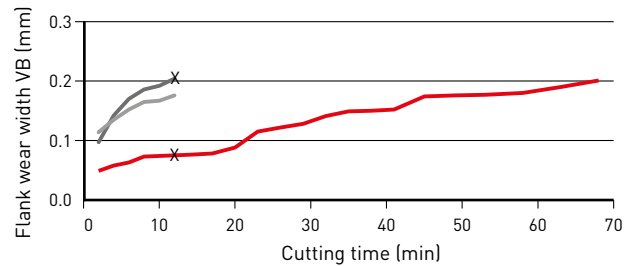

TAKEN AFTER 12 MINUTES MACHINING

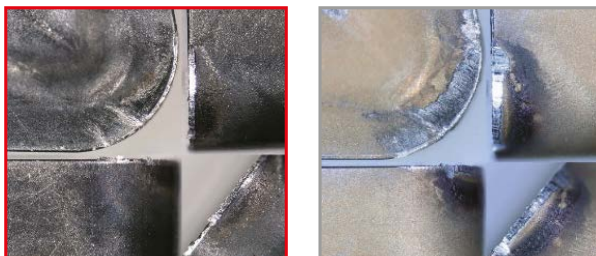

MV9005
MS Breaker

Conventional A

COMPARISON WHEN MACHINING A NICKEL-BASED SUPER ALLOY CONTAINING COBALT

Exhibits excellent wear resistance across a wide range of nickel-based heat resistant alloys.

Material	Nickel-base super alloy containing cobalt
Insert	CNMG120412-
Vc (m/min)	40
f (mm/rev)	0.15
ap (mm)	1.5
Cutting mode	Wet cutting

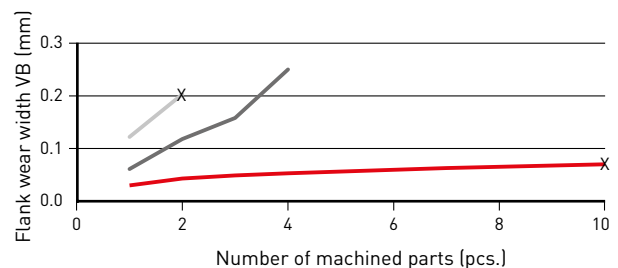

10 PARTS



MV9005
MS Breaker

1 PART



Conventional B



CNMG

NEGATIVE INSERTS (WITH HOLE)

M Class

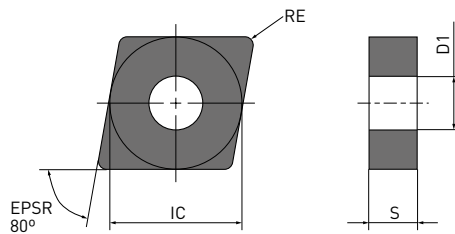
CNMG



Order number	  	MV9005	IC	S	RE	D1
CNMG120402-LS	L	●	12.7	4.76	0.2	5.16
CNMG120404-LS	L	●	12.7	4.76	0.4	5.16
CNMG120408-LS	L	●	12.7	4.76	0.8	5.16
CNMG120404-MS	M	●	12.7	4.76	0.4	5.16
CNMG120408-MS	M	●	12.7	4.76	0.8	5.16
CNMG120412-MS	M	●	12.7	4.76	1.2	5.16
CNMG120408-MA	M	●	12.7	4.76	0.8	5.16
CNMG120412-MA	M	●	12.7	4.76	1.2	5.16
CNMG120416-MA	M	●	12.7	4.76	1.6	5.16
CNMG120408-RS	R	●	12.7	4.76	0.8	5.16
CNMG120412-RS	R	●	12.7	4.76	1.2	5.16
CNMG120416-RS	R	●	12.7	4.76	1.6	5.16
CNMG190616-RS	R	●	19.05	6.35	1.6	7.93

1/1







DNMG

NEGATIVE INSERTS (WITH HOLE)

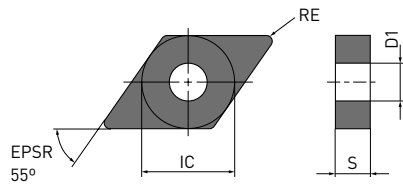
M Class

DNMG



Order number	  	MV9005	IC	S	RE	D1
DNMG150402-LS	L	●	12.7	4.76	0.2	5.16
DNMG150404-LS	L	●	12.7	4.76	0.4	5.16
DNMG150408-LS	L	●	12.7	4.76	0.8	5.16
DNMG150404-MS	M	●	12.7	4.76	0.4	5.16
DNMG150408-MS	M	●	12.7	4.76	0.8	5.16
DNMG150412-MS	M	●	12.7	4.76	1.2	5.16
DNMG150404-MA	M	●	12.7	4.76	0.4	5.16
DNMG150408-MA	M	●	12.7	4.76	0.8	5.16
DNMG150412-MA	M	●	12.7	4.76	1.2	5.16

1/1







SNMG

NEGATIVE INSERTS (WITH HOLE)

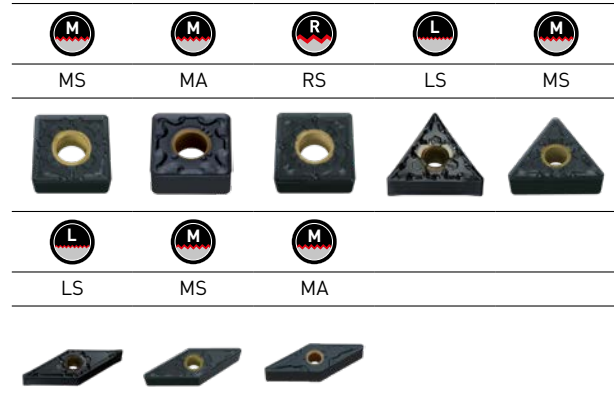
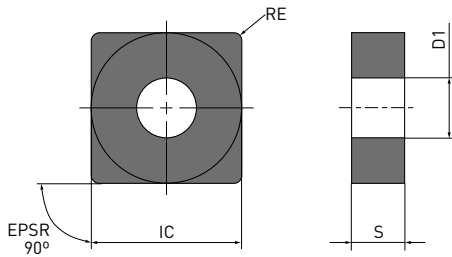
M Class

SNMG



Order number	  	MV9005	IC	S	RE	D1
SNMG120404-MS	M	●	12.7	4.76	0.4	5.16
SNMG120408-MS	M	●	12.7	4.76	0.8	5.16
SNMG120412-MS	M	●	12.7	4.76	1.2	5.16
SNMG120404-MA	M	●	12.7	4.76	0.4	5.16
SNMG120408-MA	M	●	12.7	4.76	0.8	5.16
SNMG120412-MA	M	●	12.7	4.76	1.2	5.16
SNMG120408-RS	R	●	12.7	4.76	0.8	5.16
SNMG120412-RS	R	●	12.7	4.76	1.2	5.16
SNMG120416-RS	R	●	12.7	4.76	1.6	5.16

1/1



TNMG

NEGATIVE INSERTS (WITH HOLE)

M Class

TNMG

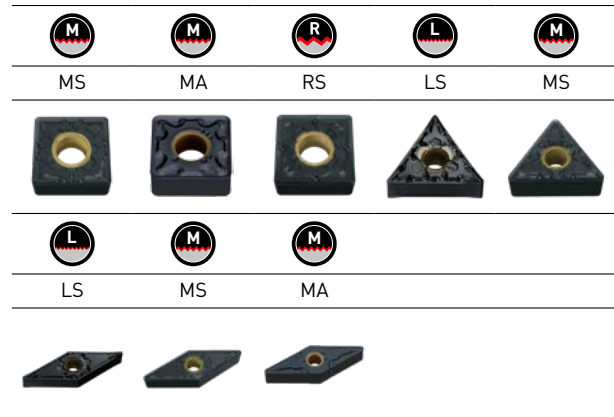
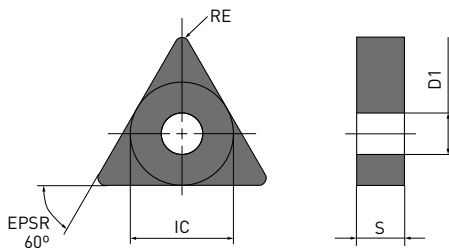

Order number		MV9005	IC	S	RE	D1
TNMG160402-LS	L	●	9.525	4.76	0.2	3.81
TNMG160404-LS	L	●	9.525	4.76	0.4	3.81
TNMG160408-LS	L	●	9.525	4.76	0.8	3.81
TNMG160404-MS	M	●	9.525	4.76	0.4	3.81
TNMG160408-MS	M	●	9.525	4.76	0.8	3.81
TNMG160412-MS	M	●	9.525	4.76	1.2	3.81

1/1







VNMG

NEGATIVE INSERTS (WITH HOLE)

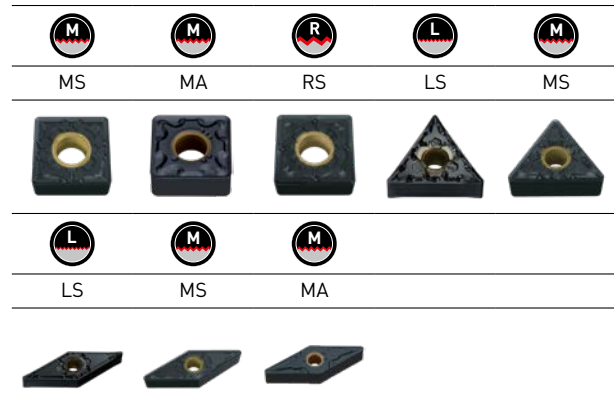
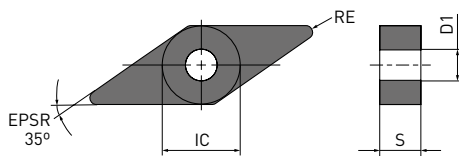
M Class

VNMG



Order number	  	MV9005	IC	S	RE	D1
VNMG160402-LS	L	●	9.525	4.76	0.2	3.81
VNMG160404-LS	L	●	9.525	4.76	0.4	3.81
VNMG160408-LS	L	●	9.525	4.76	0.8	3.81
VNMG160404-MS	M	●	9.525	4.76	0.4	3.81
VNMG160408-MS	M	●	9.525	4.76	0.8	3.81
VNMG160404-MA	M	●	9.525	4.76	0.4	3.81
VNMG160408-MA	M	●	9.525	4.76	0.8	3.81

1/1



RCMT/ RCMX

7° POSITIVE INSERTS (WITH HOLE)

M Class

RCMT/RCMX

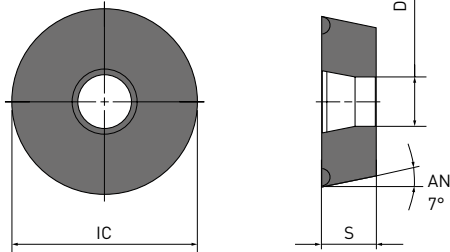

Order number	  	MV9005	IC	S	RE	D1
RCMT0602M0	M	●	6.0	2.38	—	2.8
RCMT0803M0	M	●	8.0	3.18	—	3.4
RCMT10T3M0	M	●	10.0	3.97	—	4.4
RCMT1204M0	M	●	12.0	4.76	—	4.4
RCMT1606M0	M	●	16.0	6.35	—	5.5
RCMX1003M0	M	●	10.0	3.18	—	3.6
RCMX1204M0	M	●	12.0	4.76	—	4.2
RCMX1606M0	M	●	16.0	6.35	—	5.2

1/1



MV9005

RECOMMENDED CUTTING CONDITIONS

NEGATIVE INSERTS

Material	Conditions	Grade	Vc	f	ap	
S Ni based heat resistant alloys (Inconel®718, Hastelloy®, Waspaloy®)	● L	MV9005	LS	50 – 110	0.10 – 0.25	0.2 – 0.8
	● M	MV9005	MS	50 – 100	0.15 – 0.30	0.5 – 3.0

1/1

1. Verify the recommended conditions for each boring bar as cutting conditions for internal machining can differ.

POSITIVE INSERTS

Material	Conditions	Grade	Vc	f	ap
S Ni based heat resistant alloys (Inconel®718, Hastelloy®, Waspaloy®)	● M	MV9005	40 – 80	0.25 – 0.45	1.5 – 3.0

1/1

1. Verify the recommended conditions for each boring bar as cutting conditions for internal machining can differ.

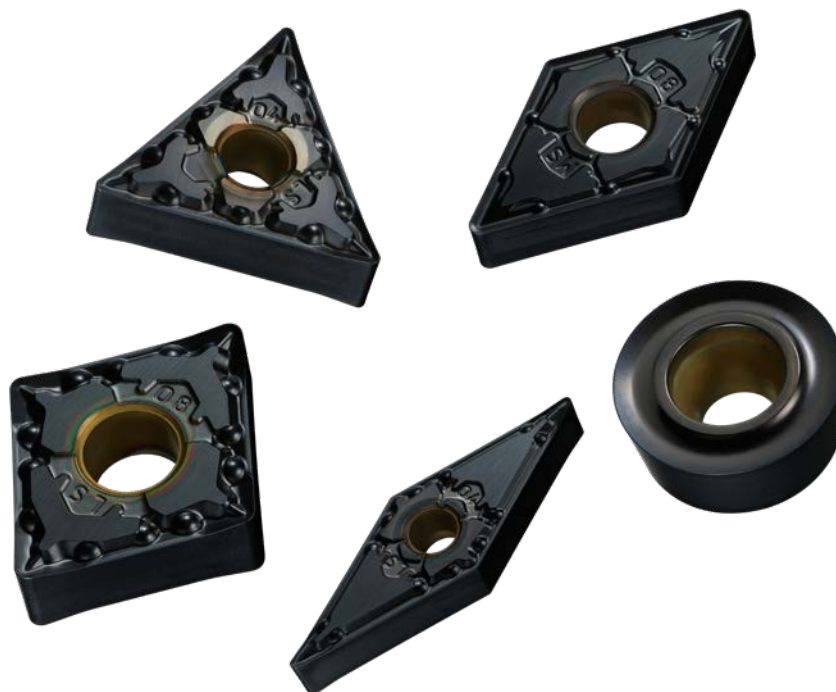

MV9005

EXAMPLE OF USAGE

Insert	CNMG120412-MS
Material	Nickel-base super alloy containing cobalt
Component	Aerospace component
Application	Face
Vc (m/min)	40
f (mm/rev)	0.15
ap (mm)	1.5
Cutting mode	Wet cutting

Results

Notch wear is suppressed, and it is possible to significantly extend the tool life.

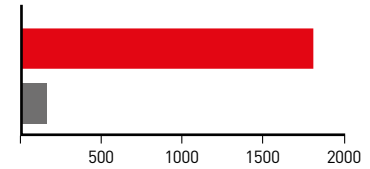
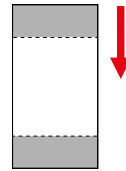

Insert	CNMG120412-MS
Material	Inconel [®] 718
Component	Aerospace component
Application	Turning
Vc (m/min)	MV9005 = 100 Conventional = 80
f (mm/rev)	MV9005 = 0.30 Conventional = 0.25
ap (mm)	0.15 – 0.35
Cutting mode	Wet cutting

Results

Cutting conditions improve machining efficiency by 50 % compared to conventional products. Premature wear is also suppressed and stable machining is achieved.

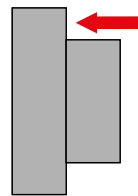

Insert	CNMG120412-MS
Material	Inconel [®] 718
Component	Aerospace component
Application	Internal
Vc (m/min)	MV9005 = 100 Conventional = 80
f (mm/rev)	MV9005 = 0.18 Conventional = 0.15
ap (mm)	0.15 – 0.35
Cutting mode	Wet cutting

Results

Machining efficiency is 50 % higher than conventional products. Premature wear is suppressed even under increased cutting conditions, enabling stable machining.

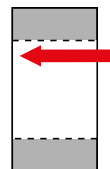

The examples shown are customer's applications, therefore can differ from the recommended conditions.

MMT THREADING SERIES

FOR HIGHLY EFFICIENT AND PRECISION MACHINING
OVER A WIDE RANGE OF THREADING APPLICATIONS

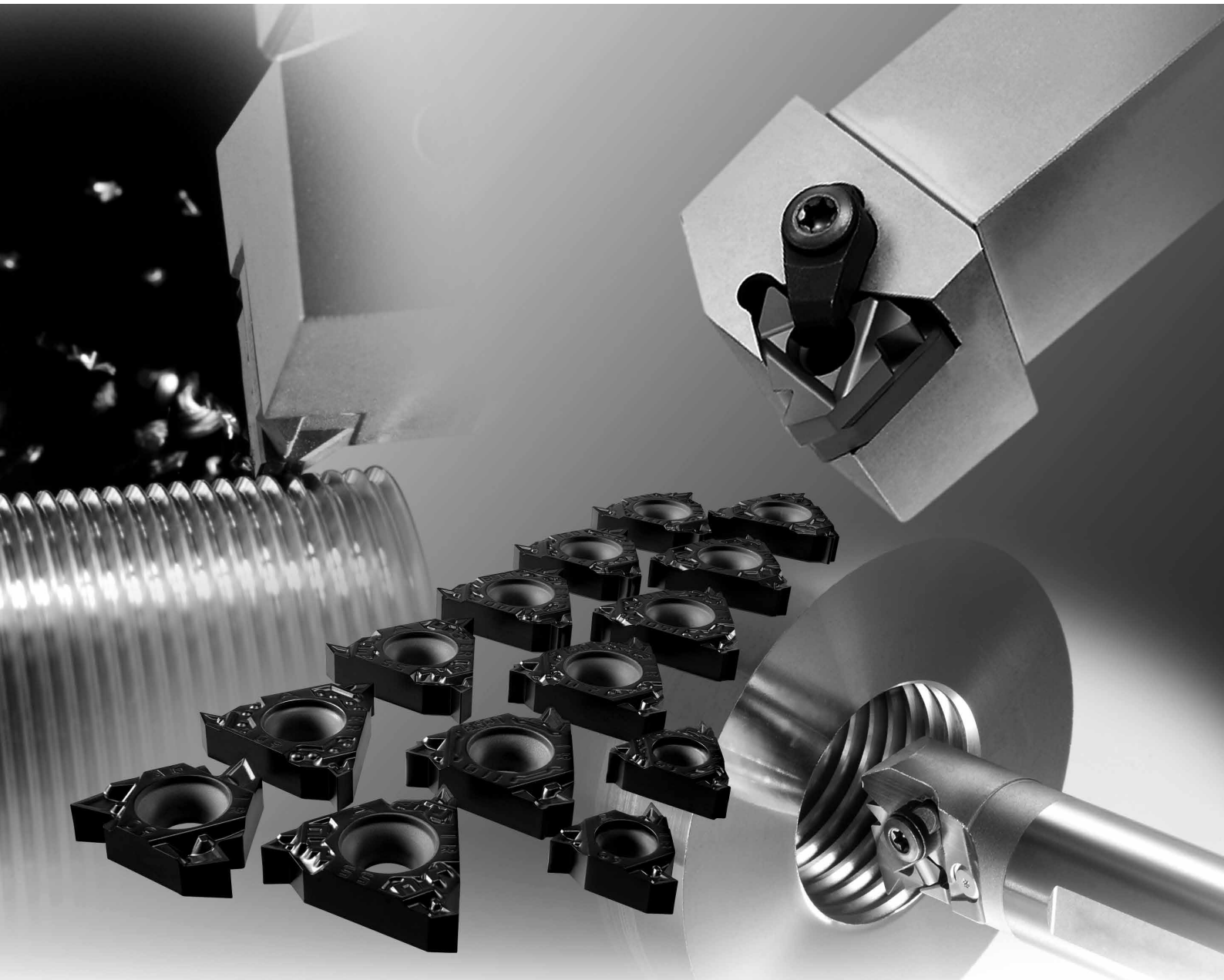

Interested in more...

B053

www.mhg-mediastore.net



DIA  **EDGE**

FEATURES OF MMT SERIES

A WIDE VARIETY OF PRODUCTS

M-CLASS INSERTS WITH 3-D CHIPBREAKERS

M, UNC, UNF, W, G, Rp, R, Rc

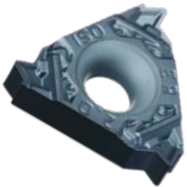

G-CLASS GROUND INSERTS

M, UNC, UNF, W,
G, Rp, R, Rc,
NPTF, NPT

Rd, CSG, LCSG

Tr, ACME, BCSG

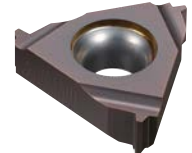
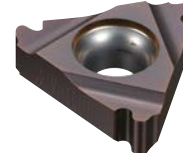
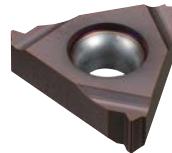

IDEAL CHIP CONTROL EVEN DURING THE LATTER HALF OF PASSES WHEN CONTINUOUS CHIPS ARE USUALLY PRODUCED (M-CLASS INSERTS WITH 3-D CHIPBREAKERS)

Workpiece	DIN 41CrMo4
Insert	MMT16ER150ISO-S
Grade	VP15TF
Vc (m/min)	120
Cutting method	Radial infeed
Depth of cut	Fixed cut area
Pass (times)	6
Coolant	Wet

ISO metric external thread pitch 1.5 mm
Final pass (6th pass)



MMT



Conventional

A HIGHER LEVEL OF PRECISION THAN CONVENTIONAL INSERTS (G-CLASS GROUND INSERTS)

Thread type	Threading tolerance
ISO Metric	6g / 6H
American UN	2A / 2B
Whitworth for BSW, BSP	Medium class A
BSPT	Standard BSPT
Round DIN 405	7h / 7H
ISO Trapezoidal 30°	7e / 7H
American ACME	3G
UNJ	3A
API Buttress Casing	Standard API
API Rounded Casing & Tubing	Standard API RD
American NPT	Standard NPT
American NPTF	Class 2

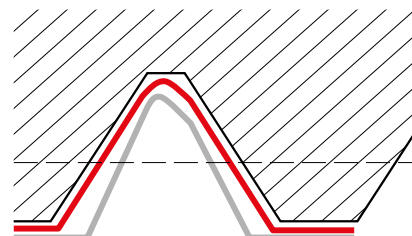

High precision threading can be achieved by using MMT inserts that feature ground rake faces and peripheral cutting edges.

■ MMT series

■ Theoretical thread profile

■ Conventional insert

FEATURES OF MMT SERIES

NEW

AG TYPE IS ADDED TO THE ACCURATE M-CLASS TYPE 3-D CHIPBREAKER

For general purpose 60° and 55° inner/outer diameter threading, the AG type has been added to the precision M-class 3-D chipbreaker range, which is applicable to 48 – 8 threads and a pitch of 0.5 – 3.0 mm to meet a wide range of needs. The M-class precision 3-D chipbreaker improves chip control and contributes to tool cost reduction.



CHOOSING M-CLASS INSERTS WITH 3-D CHIPBREAKERS OR G-CLASS INSERTS

- For ideal chip control and a high cost performance ratio, M-class inserts with 3-D chipbreakers are recommended.
- G-class inserts are recommended where higher precision is required.

Insert	Chip control	Precision of thread
M-class inserts with 3-D chipbreakers	◎	○



Insert	Chip control	Precision of thread
G-class inserts	○	◎

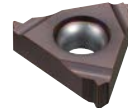

HOLDER (USE OF SPECIAL SURFACE TREATMENT)

EXTERNAL

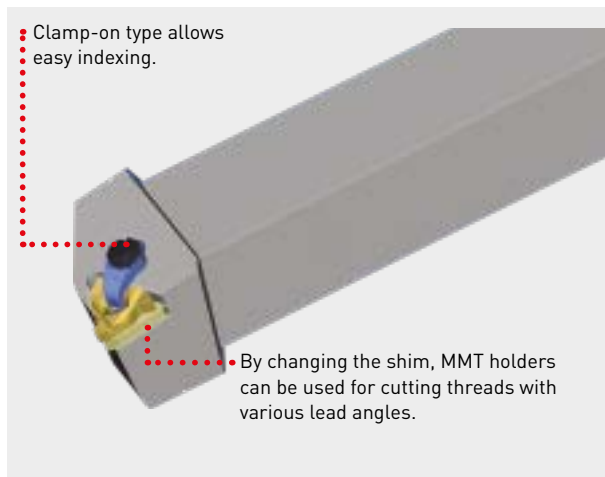

INTERNAL

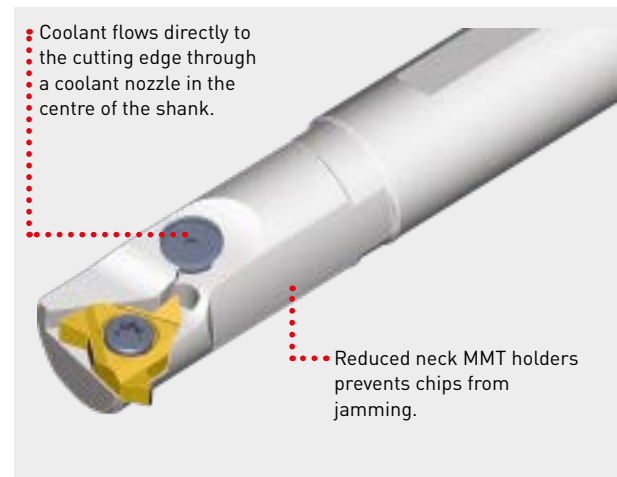

Order number of coolant guide screw: TFS03006
(Except MMTIR1316/MMTIR1516)

SUITABLE FOR THREADING WITH A LARGE LEAD ANGLE

Lead angle (α°)	Inclination angle (0°)
-1.5°	-3°
-0.5°	-2°
0.5°	-1°
1.5°	0°
2.5°	1°
3.5°	2°
4.5°	3°

Standard shim delivered with the holder.

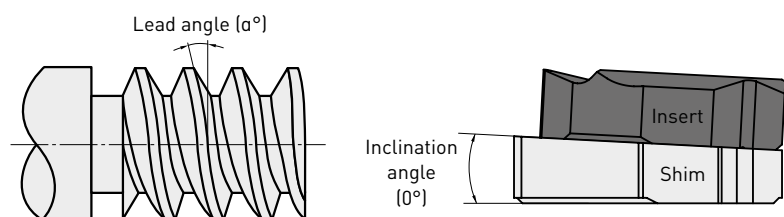

By changing only the shim, MMT holders can be used for turning of threads with various lead angles as well as the turning of left hand threads.

PVD COATED CARBIDE GRADE FOR STABLE THREADING

MP9025

Tough grade with an emphasis on cutting edge stability.

Demonstrates excellent fracture resistance when machining at low cutting speeds, internal machining, and even on small corner R sizes.

With excellent adhesion resistance, it is effective when machining heat resistant alloys and precipitation hardening stainless steel.

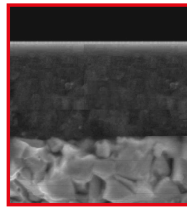

••• High Al-rich (Al,Ti)N single layer coating technology

••• Special cemented carbide substrate

HIGH AL AND CONVENTIONAL COATING COMPARISON

The new technology, high Al-rich (Al,Ti)N single layer coating provides stabilisation of the high hardness phase and succeeds in dramatically improving wear, crater and welding resistance.

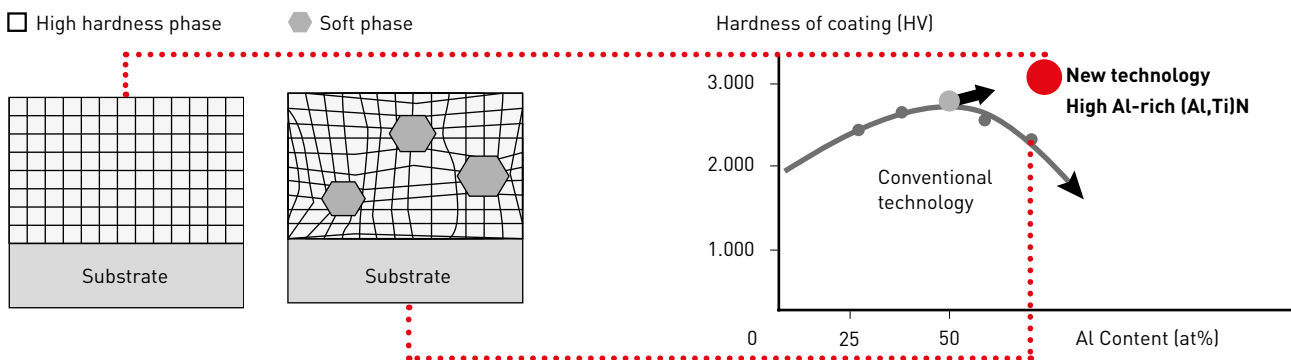

VP10MF

High wear and plastic deformation resistance for threading when maintaining the thread form is important. Suitable for continuous high precision machining with extensive tool life. Effective in combination with G-class inserts for high precision threading.

VP15TF

High fracture resistance during low rigidity applications such as bar feed machining. Able to withstand harsh conditions for long periods where conventional inserts would be liable to breakage. Effective combination of high cost performance M-class inserts with 3-D chipbreakers.

VP20RT

Suitable for stainless steel boring and unstable machining where inserts are vulnerable to fracturing. Effective combination of high cost performance M-class inserts with 3-D chipbreakers.

MMT SERIES ORDER NUMBER

HOLDERS

EXTERNAL

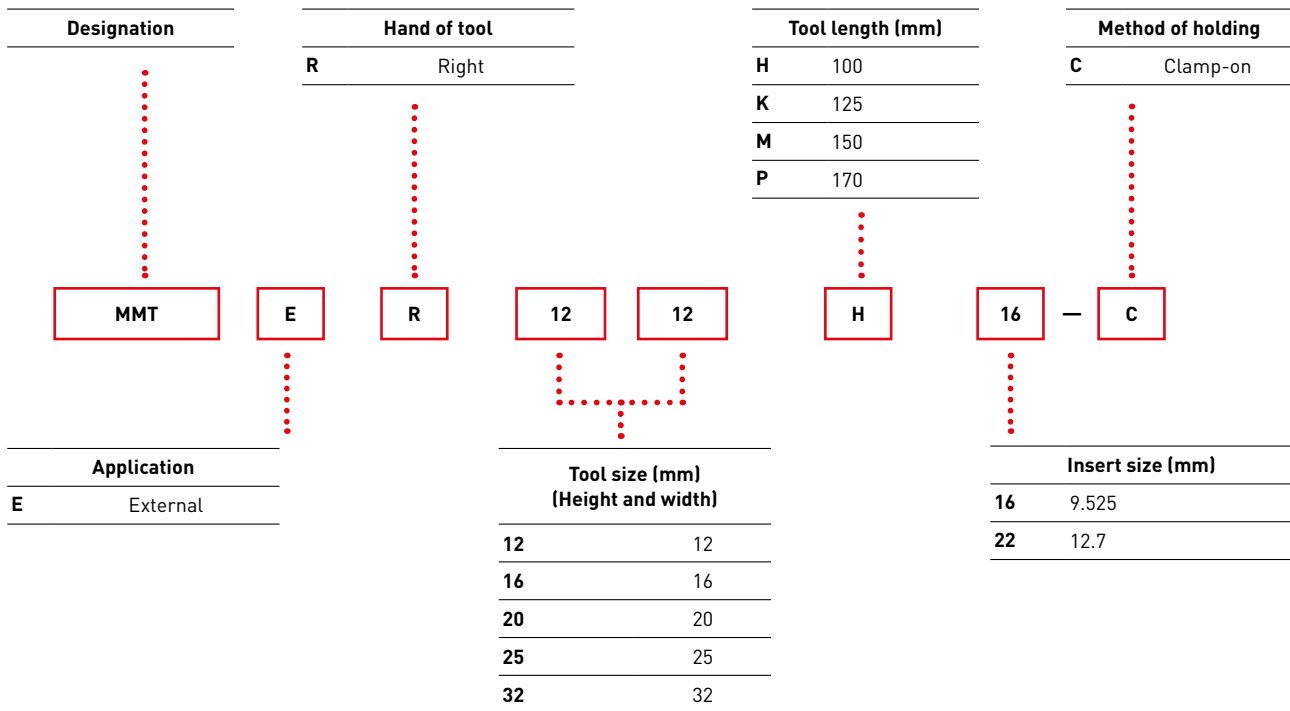

INTERNAL

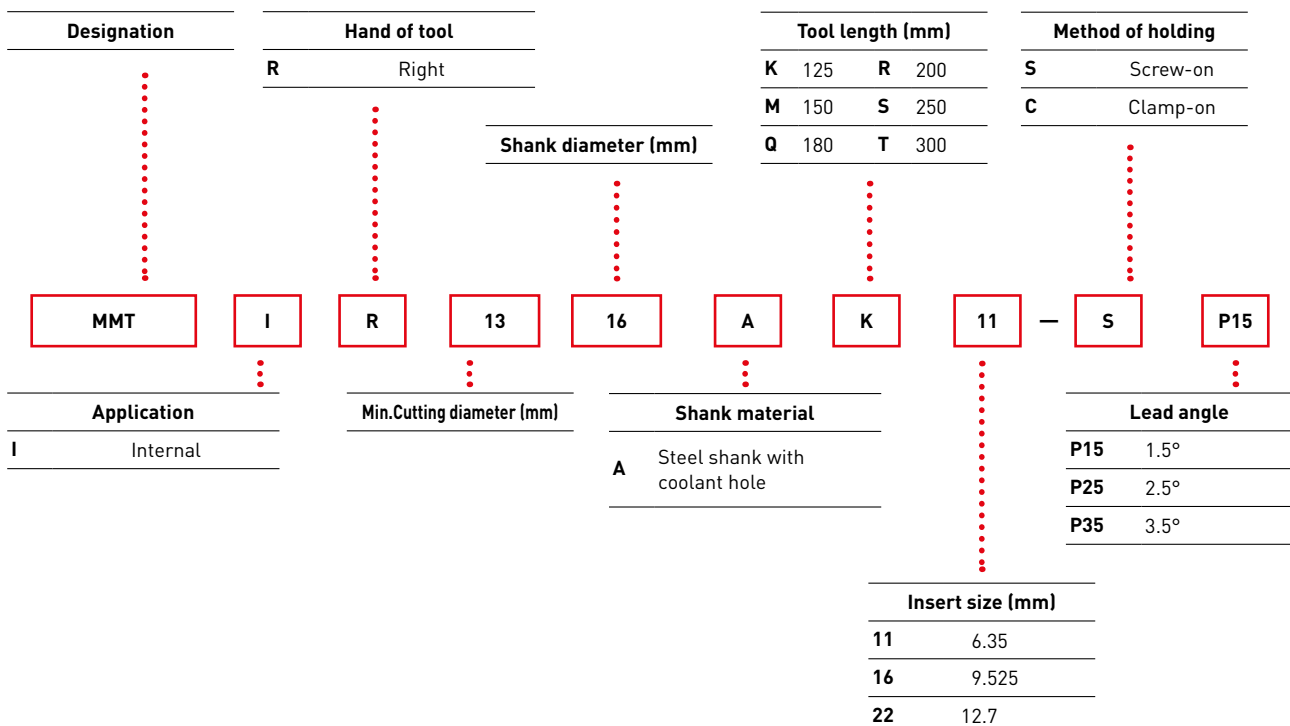

MMTE HOLDER

EXTERNAL THREADING

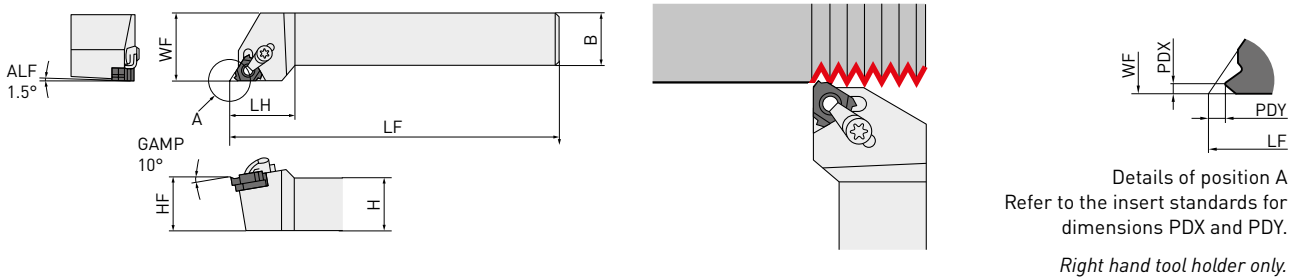







Order number	Stock R	H	B	LF	LH	HF	WF	Insert number
MMTER1212H16-C	●	12	12	100	25	12	16	MMT16ER ○○○○○
MMTER1616H16-C	●	16	16	100	25	16	20	
MMTER2020K16-C	●	20	20	125	26	20	25	
MMTER2525M16-C	●	25	25	150	28	25	32	
MMTER3232P16-C	●	32	32	170	32	32	40	MMT22ER ○○○○○
MMTER2525M22-C	●	25	25	150	32	25	32	
MMTER3232P22-C	●	32	32	170	32	32	40	

(5 inserts per case)



SPARE PARTS

Order number	 Clamp bridge	 Clamp screw *	 Stop ring	 Shim screw *	 Shim	 Wrench
MMTER1212H16-C						
MMTER1616H16-C						
MMTER2020K16-C	SETK51	SETS51	CR4	HFC03008	CTE32TP15	1.TKY15F 2.HKY20R
MMTER2525M16-C						
MMTER3232P16-C						
MMTER2525M22-C						
MMTER3232P22-C	SETK61	SETS61	CR5	HFC04010	CTE43TP15	1.TKY20F 2.HKY25R

1. Select and use a shim as shown below (sold separately), dependant on the lead angle.

* Clamp Torque (N • m): SETS51 = 3.5, SETS61 = 5.0, HFC03008 = 1.5, HFC04010 = 2.2

SHIM

Lead angle (α°)	Order number	Stock R	Inclination angle (0°)	Applicable holder	Lead angle (α°)	Order number	Stock R	Inclination angle (0°)	Applicable holder
-1.5°	CTE32TN15	●	-3°	MMTER ○○○○○ 16-C	-1.5°	CTE43TN15	●	-3°	MMTER ○○○○○ 22-C
-0.5°	CTE32TN05	●	-2°		-0.5°	CTE43TN05	●	-2°	
0.5°	CTE32TP05	●	-1°		0.5°	CTE43TP05	●	-1°	
1.5°	CTE32TP15	●	0°		1.5°	CTE43TP15	●	0°	
2.5°	CTE32TP25	●	1°		2.5°	CTE43TP25	●	1°	
3.5°	CTE32TP35	●	2°		3.5°	CTE43TP35	●	2°	
4.5°	CTE32TP45	●	3°	4.5°	CTE43TP45	●	3°		

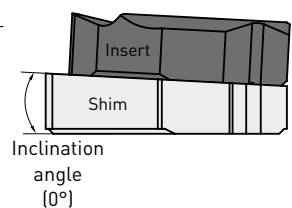

Standard shim delivered with the holder.

● : Inventory maintained. ★ : Inventory maintained in Japan.

MMT

M-CLASS INSERTS WITH 3-D CHIPBREAKERS

INSERTS

Order number	NEW MP9025	VP15TF	VP20RT	Pitch mm	Thread/ inch	IC	S	PDY	PDX	RE	Total cutting depth	Geometry
PARTIAL PROFILE 60°												
MMT16ERAG60-S	●	●	●	0.5-3.0	48-8	9.525	3.44	1.2	1.7	0.08	—	Partial form
MMT16ERA60-S	●		●	0.5-1.5	48-16	9.525	3.44	0.8	0.9	0.06	—	
MMT16ERG60-S	●		●	1.75-3.0	14-8	9.525	3.44	1.2	1.7	0.23	—	
PARTIAL PROFILE 55°												
MMT16ERAG55-S	●	●	●		48-8	9.525	3.44	1.2	1.7	0.07	—	Partial form
MMT16ERA55-S	●		●		48-16	9.525	3.44	0.8	0.9	0.07	—	
MMT16ERG55-S	●		●		14-8	9.525	3.44	1.2	1.7	0.23	—	
ISO METRIC												
MMT16ER100ISO-S	●			1.0		9.525	3.44	0.7	0.7	0.13	0.61	Full form
MMT16ER125ISO-S	●			1.25		9.525	3.44	0.8	0.9	0.16	0.77	
MMT16ER150ISO-S	●			1.5		9.525	3.44	0.8	1.0	0.20	0.92	
MMT16ER175ISO-S	●			1.75		9.525	3.44	0.9	1.2	0.22	1.07	
MMT16ER200ISO-S	●			2.0		9.525	3.44	1.0	1.3	0.26	1.23	
MMT16ER250ISO-S	●			2.5		9.525	3.44	1.1	1.5	0.33	1.53	
MMT16ER300ISO-S	●			3.0		9.525	3.44	1.2	1.6	0.40	1.84	
AMERICAN UN												
MMT16ER160UN-S	★		★		16	9.525	3.44	0.9	1.1	0.23	0.97	Full form
MMT16ER140UN-S	★		★		14	9.525	3.44	1.0	1.2	0.26	1.11	
MMT16ER120UN-S	★		★		12	9.525	3.44	1.1	1.4	0.30	1.30	

1/2

(5 inserts per case)



● / ★ = Expansion

● : Inventory maintained. ★ : Inventory maintained in Japan.

MMT – M-CLASS INSERTS WITH 3-D CHIPBREAKERS

Order number	NEW MP9025	VP15TF	VP20RT	Pitch mm	Thread/ inch	IC	S	PDY	PDX	RE	Total cutting depth	Geometry
WHITWORTH FOR BSW, BSP												
MMT16ER190W-S	●		●		19	9.525	3.44	0.8	1.0	0.18	0.86	Full form
MMT16ER140W-S	●		●		14	9.525	3.44	1.0	1.2	0.25	1.16	
MMT16ER110W-S	●		●		11	9.525	3.44	1.1	1.5	0.32	1.48	
BSPT												
MMT16ER190BSPT-S	★		★		19	9.525	3.44	0.8	0.9	0.18	0.86	Full form
MMT16ER140BSPT-S	★		★		14	9.525	3.44	1.0	1.2	0.25	1.16	
MMT16ER110BSPT-S	★		★		11	9.525	3.44	1.1	1.5	0.32	1.48	

2/2

(5 inserts per case)



1. Identification: Please see page 26 (M-Class).

● / ★ = Expansion

● : Inventory maintained. ★ : Inventory maintained in Japan.

MMTE HOLDER

RECOMMENDED CUTTING CONDITIONS

EXTERNAL THREADING

Material	Hardness	Grade	Vc
P Mild steel	≤180HB	MP9025	80 (60–100)
		VP10MF	150 (70–230)
		VP15TF	100 (60–140)
		VP20RT	80 (60–100)
P Carbon steel Alloy steel	180 – 280HB	MP9025	80 (60–100)
		VP10MF	140 (80–200)
		VP15TF	100 (60–140)
M Stainless steel	≤200HB	VP20RT	80 (60–100)
		MP9025	80 (40–120)
		VP15TF	80 (40–120)
K Gray cast iron	Tensile Strength ≤350MPa	VP20RT	80 (40–120)
		VP10MF	140 (80–200)
S Heat-resistant alloy	—	VP15TF	90 (60–120)
		MP9025	30 (20– 40)
		VP10MF	45 (15– 70)
		VP15TF	30 (20– 40)
S Titanium alloy	—	VP20RT	30 (20– 40)
		MP9025	45 (25– 65)
		VP10MF	60 (40– 80)
		VP15TF	45 (25– 65)
H Heat-treated alloy	45 – 55HRC	VP20RT	45 (25– 65)
		VP10MF	50 (30– 70)
		VP15TF	40 (20– 60)

1/1

MMTI BORING BARS

INTERNAL THREADING

1 Screw-on type

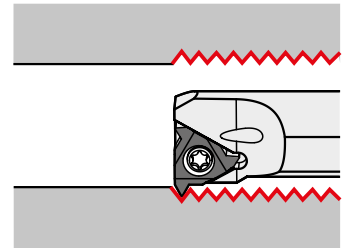
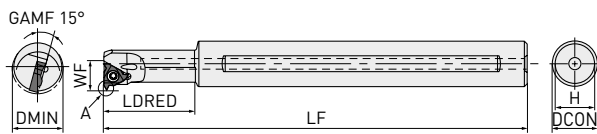

2 Clamp-on type

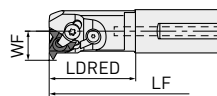

3 Screw-on type

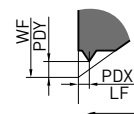
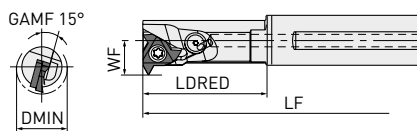

Details of position A.
Refer to the insert standards for dimensions PDX and PDY.

Right hand tool holder only.

4 Clamp-on type

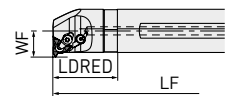







Order number	Stock	Lead angle	DCON	LF	LDRED	WF	H	DMIN	Insert number	Type
MMTIR1316AK11-SP15	●	1.5°	16	125	25	8.7	15	13		1
MMTIR1316AK11-SP25	●	2.5°	16	125	25	8.7	15	13		1
MMTIR1316AK11-SP35	●	3.5°	16	125	25	8.7	15	13		1
MMTIR1516AM11-SP15	●	1.5°	16	150	32	9.7	15	15	MMT111R ○○○○○	1
MMTIR1516AM11-SP25	●	2.5°	16	150	32	9.7	15	15		1
MMTIR1516AM11-SP35	●	3.5°	16	150	32	9.7	15	15		1
MMTIR1916AM16-SP15	●	1.5°	16	150	40	12.2	15	19		2
MMTIR1916AM16-SP25	●	2.5°	16	150	40	12.2	15	19		2
MMTIR1916AM16-SP35	●	3.5°	16	150	40	12.2	15	19	MMT161R ○○○○○	2
MMTIR2420AQ16-C	●	1.5°	20	180	40	14.2	19	24		3
MMTIR2925AS16-C	●	1.5°	25	250	60	16.7	23.4	29		3
MMTIR3732AS16-C	●	1.5°	32	250	48	20.5	30.4	37		4
MMTIR2420AQ22-SP15	●	1.5°	20	180	50	15.5	19	24		2
MMTIR2420AQ22-SP25	●	2.5°	20	180	50	15.5	19	24		2
MMTIR2420AQ22-SP35	●	3.5°	20	180	50	15.5	19	24	MMT221R ○○○○○	2
MMTIR3025AR22-C	●	1.5°	25	200	38	17.8	23.4	30		4
MMTIR3832AS22-C	●	1.5°	32	250	48	21.8	30.4	38		4
MMTIR4640AT22-C	●	1.5°	40	300	60	26.2	38	46		4

1/1



MMTI - INTERNAL THREADING

SPARE PARTS

Order number							Type
	Clamp bridge	Clamp screw	Stop ring	1. Shim screw 2. Embedded shim screw	Shim	Wrench	
MMTIR1316AK11-SP15	—	TS25	—	—	—	1.TKY08F	1
MMTIR1316AK11-SP25	—	TS25	—	—	—	1.TKY08F	1
MMTIR1316AK11-SP35	—	TS25	—	—	—	1.TKY08F	1
MMTIR1516AM11-SP15	—	TS25	—	—	—	1.TKY08F	1
MMTIR1516AM11-SP25	—	TS25	—	—	—	1.TKY08F	1
MMTIR1516AM11-SP35	—	TS25	—	—	—	1.TKY08F	1
MMTIR1916AM16-SP15	—	CS350860T	—	—	—	1.TKY15F	2
MMTIR1916AM16-SP25	—	CS350860T	—	—	—	1.TKY15F	2
MMTIR1916AM16-SP35	—	CS350860T	—	—	—	1.TKY15F	2
MMTIR2420AQ16-C	SETK51	SETS51	CR4	1.HFC03006 / 2.TFS03006	CTI32TP15	1.TKY15F / 2.HKY20R	3
MMTIR2925AS16-C	SETK51	SETS51	CR4	1.HFC03006 / 2.TFS03006	CTI32TP15	1.TKY15F / 2.HKY20R	3
MMTIR3732AS16-C	SETK51	SETS51	CR4	1.HFC03006 / 2.TFS03006	CTI32TP15	1.TKY15F / 2.HKY20R	4
MMTIR2420AQ22-SP15	—	TS43	—	—	—	1.TKY15F	2
MMTIR2420AQ22-SP25	—	TS43	—	—	—	1.TKY15F	2
MMTIR2420AQ22-SP35	—	TS43	—	—	—	1.TKY15F	2
MMTIR3025AR22-C	SETK61	SETS61	CR5	1.HFC04008 / 2.TFS03006	CTI43TP15	1.TKY20F / 2.HKY25R	4
MMTIR3832AS22-C	SETK61	SETS61	CR5	1.HFC04008 / 2.TFS03006	CTI43TP15	1.TKY20F / 2.HKY25R	4
MMTIR4640AT22-C	SETK61	SETS61	CR5	1.HFC04008 / 2.TFS03006	CTI43TP15	1.TKY20F / 2.HKY25R	4

1. Select and use a shim as shown below (sold separately), dependant on the lead angle.
- A screw-on tool holder uses no shim. (The holder body has a lead angle.) Use a tool holder with the appropriate lead angle.
 - Min. cutting diameter (DMIN) shows the internal hole diameter, not the thread diameter.
- * Clamp Torque (N • m): TS25 = 1.0, CS350860T = 3.5, SETS51 = 3.5, TS43 = 3.5, SETS61 = 5.0, HFC03006 = 1.5, HFC04008 = 2.2

SHIM

Lead angle (α°)	Order number	Stock R	Inclination angle (0°)	Applicable holder	Lead angle (α°)	Order number	Stock R	Inclination angle (0°)	Applicable holder
-1.5°	CTI32TN15	●	-3°	MMTIR ○○○○ ○○16-C	-1.5°	CTI43TN15	●	-3°	MMTIR ○○○○ ○○22-C
-0.5°	CTI32TN05	●	-2°		-0.5°	CTI43TN05	●	-2°	
0.5°	CTI32TP05	●	-1°		0.5°	CTI43TP05	●	-1°	
1.5°	CTI32TP15	●	0°		1.5°	CTI43TP15	●	0°	
2.5°	CTI32TP25	●	1°		2.5°	CTI43TP25	●	1°	
3.5°	CTI32TP35	●	2°		3.5°	CTI43TP35	●	2°	
4.5°	CTI32TP45	●	3°		4.5°	CTI43TP45	●	3°	

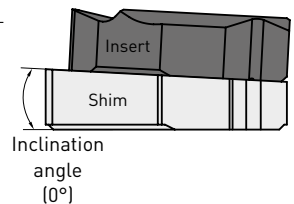

Standard shim delivered with the holder.

MMT

M-CLASS INSERTS WITH 3-D CHIPBREAKERS

INSERTS

Order number	NEW MP9025	VP15TF	VP20RT	Pitch mm	Thread/ inch	IC	S	PDY	PDX	RE	Total cutting depth	Geometry	
PARTIAL PROFILE 60°													
MMT11IRA60-S	●		●	0.5 - 1.5	48 - 16	6.35	3.04	0.8	0.9	0.03	—	Partial form 	
MMT16IRAG60-S	●	●	●	0.5 - 3.0	48 - 8	9.525	3.44	1.2	1.7	0.05	—		
MMT16IRA60-S	●		●	0.5 - 1.5	48 - 16	9.525	3.44	0.8	0.9	0.03	—		
MMT16IRG60-S	●		●	1.75 - 3.0	14 - 8	9.525	3.44	1.2	1.7	0.11	—		
PARTIAL PROFILE 55°													
MMT11IRA55-S	●		●		48 - 16	6.35	3.04	0.8	0.9	0.07	—	Partial form 	
MMT16IRAG55-S	●	●	●		48 - 8	9.525	3.44	1.2	1.7	0.07	—		
MMT16IRA55-S	●		●		48 - 16	9.525	3.44	0.8	0.9	0.07	—		
MMT16IRG55-S	●		●		14 - 8	9.525	3.44	1.2	1.7	0.21	—		
ISO METRIC													
MMT11IR100ISO-S	★		★	1.0		6.35	3.04	0.6	0.7	0.06	0.58	Full form 	
MMT11IR125ISO-S	★		★	1.25		6.35	3.04	0.8	0.9	0.08	0.72		
MMT11IR150ISO-S	★		★	1.5		6.35	3.04	0.8	1.0	0.10	0.87		
MMT16IR100ISO-S	●			1.0		9.525	3.44	0.6	0.7	0.06	0.58		
MMT16IR125ISO-S	●			1.25		9.525	3.44	0.8	0.9	0.08	0.72		
MMT16IR150ISO-S	●			1.5		9.525	3.44	0.8	1.0	0.10	0.87		
MMT16IR175ISO-S	●			1.75		9.525	3.44	0.9	1.2	0.11	1.01		
MMT16IR200ISO-S	●			2.0		9.525	3.44	1.0	1.3	0.13	1.15		
MMT16IR250ISO-S	●			2.5		9.525	3.44	1.1	1.5	0.17	1.44		
MMT16IR300ISO-S	●			3.0		9.525	3.44	1.1	1.5	0.20	1.73		
AMERICAN UN													
MMT16IR160UN-S	★		★		16	9.525	3.44	0.9	1.1	0.11	0.92		Full form
MMT16IR140UN-S	★		★		14	9.525	3.44	0.9	1.2	0.12	1.05		
MMT16IR120UN-S	★		★		12	9.525	3.44	1.1	1.4	0.14	1.22		

● / ★ = Expansion

● : Inventory maintained. ★ : Inventory maintained in Japan.

MMT – M-CLASS INSERTS WITH 3-D CHIPBREAKERS

INSERTS

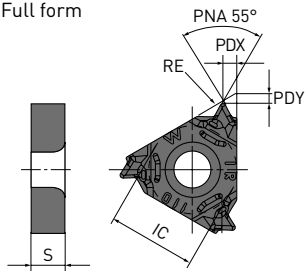
Order number	NEW MP9025	VP15TF	VP20RT	Pitch mm	Thread/ inch	IC	S	PDY	PDX	RE	Total cutting depth	Geometry
WHITWORTH FOR BSW, BSP												
MMT16IR190W-S	●		●		19	9.525	3.44	0.8	1.0	0.18	0.86	Full form 
MMT16IR140W-S	●		●		14	9.525	3.44	1.0	1.2	0.25	1.16	
MMT16IR110W-S	●		●		11	9.525	3.44	1.1	1.5	0.32	1.48	

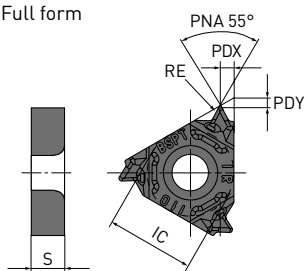
BSPT												
MMT16IR190BSPT-S	★		★		19	9.525	3.44	0.8	0.9	0.18	0.86	Full form 
MMT16IR140BSPT-S	★		★		14	9.525	3.44	1.0	1.2	0.25	1.16	
MMT16IR110BSPT-S	★		★		11	9.525	3.44	1.1	1.5	0.32	1.48	

2/2

{5 inserts per case}



1. Identification: Please see page 26 (M-Class).

● / ★ = Expansion

● : Inventory maintained. ★ : Inventory maintained in Japan.

MMTI BORING BARS

RECOMMENDED CUTTING CONDITIONS

INTERNAL THREADING

Material	Hardness	Grade	Vc
P	Mild steel ≤180HB	MP9025	80 (60–100)
		VP10MF	150 (70–230)
		VP15TF	100 (60–140)
		VP20RT	80 (60–100)
		MP9025	80 (60–100)
Carbon steel Alloy steel	180 – 280HB	VP10MF	140 (80–200)
		VP15TF	100 (60–140)
		VP20RT	80 (60–100)
M	Stainless steel ≤200HB	MP9025	80 (40–120)
		VP15TF	80 (40–120)
		VP20RT	80 (40–120)
K	Gray cast iron Tensile Strength ≤350MPa	VP10MF	140 (80–200)
		VP15TF	90 (60–120)
S	Heat-resistant alloy —	MP9025	30 (20– 40)
		VP10MF	45 (15– 70)
		VP15TF	30 (20– 40)
		VP20RT	30 (20– 40)
		MP9025	45 (25– 65)
Titanium alloy	—	VP10MF	60 (40– 80)
		VP15TF	45 (25– 65)
		VP20RT	45 (25– 65)
H	Heat-treated alloy 45 – 55HRC	VP10MF	50 (30– 70)
		VP15TF	40 (20– 60)







1/1

CUTTING PERFORMANCE

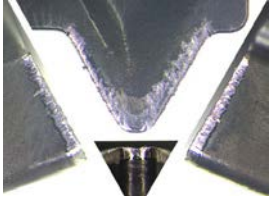
INCONEL®718 – COMPARISON OF WEAR BY MACHINING LENGTH

When threading heat resistant alloys, compound damage such as wear and plastic deformation was reduced and achieved excellent wear resistance.

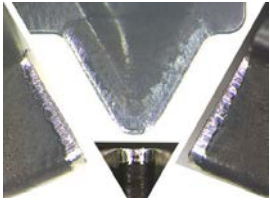
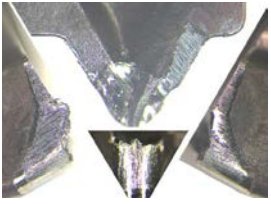
Workpiece	Inconel®718
Insert	ISO Metric 60°
Vc (m/min)	30
Pitch (mm)	1.5
Depth of cut	Total 12 passes, total depth of cut 0.92 mm, ap = 0.1 mm x 3 passes, 0.08 mm x 4 passes, 0.06 mm x 5 passes
Cutting mode	Wet cutting

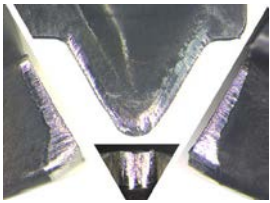
Cutting length (m)	MP9025	Conventional A	Conventional B	Conventional C
20				
25				Not machinable
35				

VQ

LATEST TECHNOLOGY, HIGH PERFORMANCE END MILLS
FOR STAINLESS AND DIFFICULT-TO-CUT MATERIALS



Interested in more...

B197

www.mhg-mediastore.net



VQ4MVM

MULTIFUNCTIONAL END MILL CAPABLE OF STRONG RAMPING CAPABILITY ON A WIDE RANGE OF MATERIALS

RAMPING IS A METHOD OF SINKING GRADUALLY AS THE TOOL TRAVERSES

This eliminates the need for a pilot hole when machining pockets, thereby reducing costs through tool consolidation. Compared to direct plunge cutting, ramping enables simultaneous multi-axis feed at high speeds to lower machining times. This method is ideal for machining wide and shallow pockets.

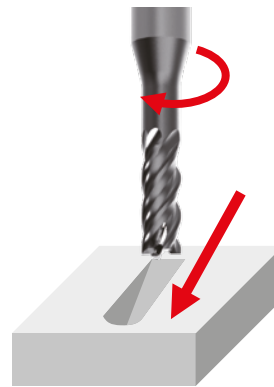

Steep ramping capability

VQ4MVM provides high-performance and multi-functionality. It can perform shoulder milling, grooving and helical machining as well as ramping angles of up to 30° in carbon and alloy steels.

14 sec

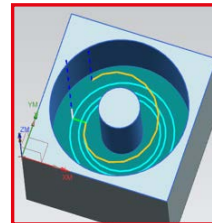

VQ4MVM

Helical and ramping
Only 1 pass needed

27 sec

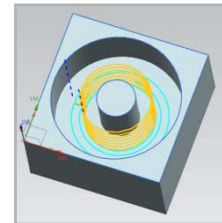

Conventional
Helical milling
7 passes needed

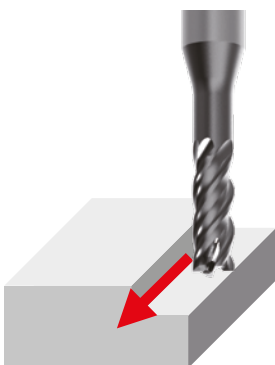

Shoulder milling

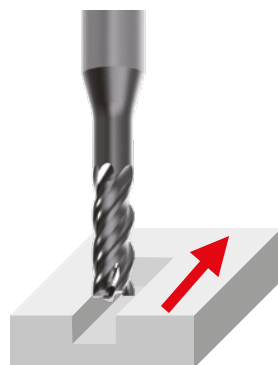

Slot milling



Pocket milling



Helical milling

VQ4MVM

HIGH PERFORMANCE END MILL

NEWLY-DEVELOPED COATING WITH IMPROVED WEAR RESISTANCE

The smoothing treatment of the coating layer reduces cutting resistance and significantly improves chip discharge.

SMART MIRACLE Coating

(Al,Cr)N coating is the most suitable coating for higher efficiency machining.

ZERO- μ Surface

The original surface treatment technology provides smooth coating layer.



SECONDARY GASH

A first and secondary gash provides high chip evacuation that far exceeds conventional designs when ramping.

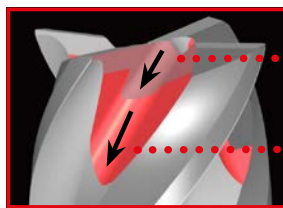

1st Gash

2nd Gash

MICRO RELIEF ANGLE

It exerts a margin effect that plays the role of a guide during machining.

Combined with irregular helix flutes, it improves vibration damping and suppresses burrs.

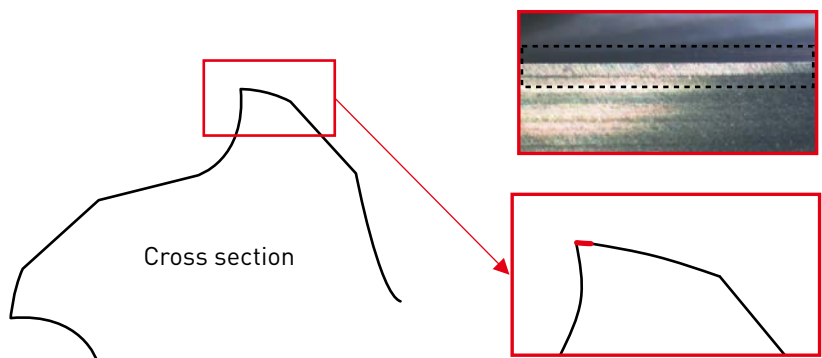

Irregular helix flutes and the micro relief angle improve vibration damping and provides excellent surface finishes.

X5CrNi18-10 Vc = 100 m/min, fz = 0.05 mm/t, ap = 5 mm, ae = 3 mm



VQ4MVM



Conventional

VQ4MVM

HIGH PERFORMANCE END MILL

CHIP POCKET AND HIGHLY RIGID GEOMETRY

VQ4MVM is suitable for strong ramping machining and chip evacuation performance due to the highly rigid geometry.

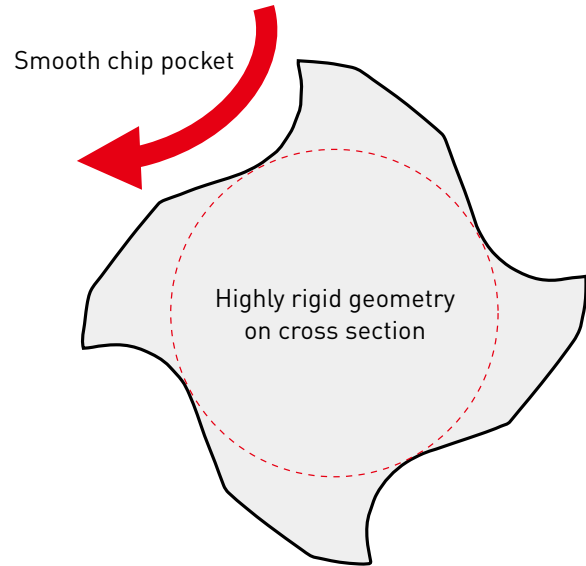
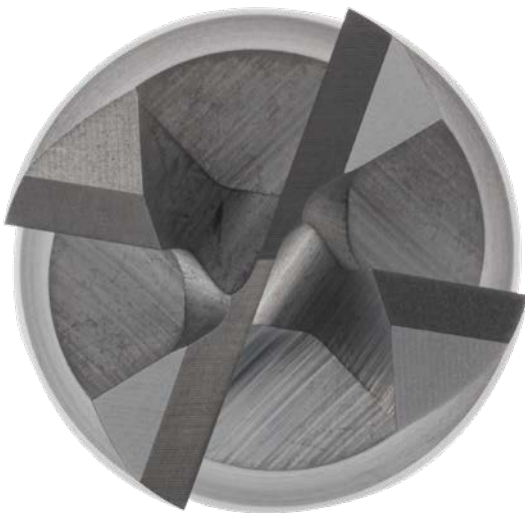

COMPARISON OF RAMPING ANGLES WHEN MACHINING X5CrNi18-10

Provided a good machined surface when machining with a ramping angle of 25°.

Material	X5CrNi18-10
Tool	Ø 10
Vc (m/min)	50
fz (mm)	0.025
ap (mm)	10
ae (mm)	10
Overhang length (mm)	35
Cutting mode	External coolant (Emulsion)
Machine	Vertical M/C (BT50)

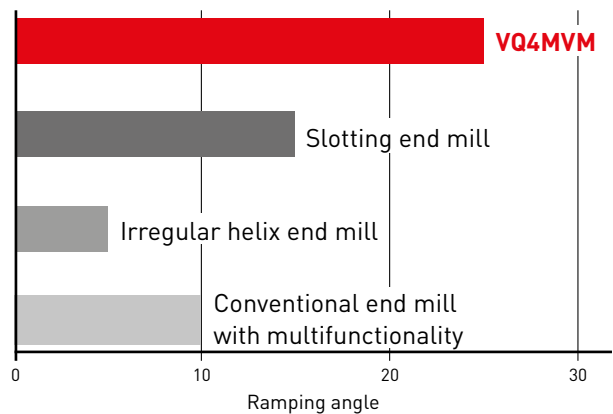

MACHINING SURFACE



VQ4MVM



Conventional end mill

SHOOTING POINT

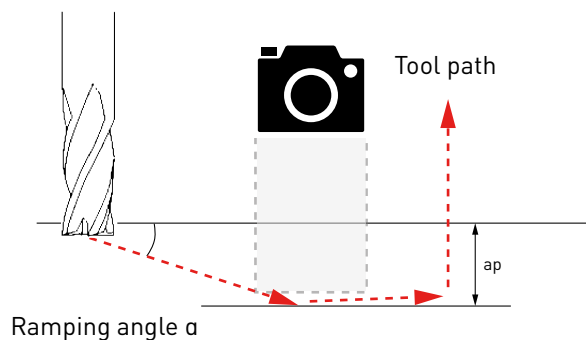

VQ4MVM



END MILL, MEDIUM CUT LENGTH, 4 FLUTE, FOR MULTIFUNCTIONAL MACHINING

P **M** **S**

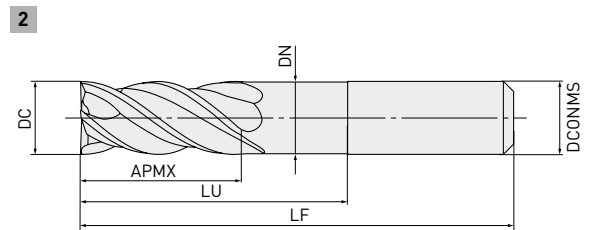
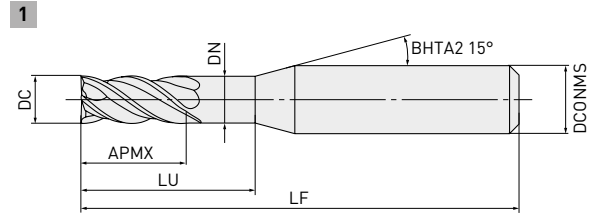

DC ≤ 12

0
-0.020



DCONMS = 6

0
-0.008



DCONMS 8, 10 DCONMS = 12

0 0
-0.009 -0.011

- Multifunctional end mill that enables a strong ramping capability.
- Chip evacuation is improved by increasing the capacity of the radial cutting edge pocket.

Order number	Stock	DC	APMX	LF	DCONMS	LU	DN	ZEFP	Type
VQ4MVMD0400N180	●	4	11	50	6	18	3.85	4	1
VQ4MVMD0500N180	●	5	13	50	6	18	4.85	4	1
VQ4MVMD0600N200	●	6	13	60	6	20	5.85	4	2
VQ4MVMD0800N240	●	8	19	60	8	24	7.85	4	2
VQ4MVMD1000N300	●	10	22	70	10	30	9.70	4	2
VQ4MVMD1200N360	●	12	26	75	12	36	11.70	4	2

1/1



VQ4MVM

RECOMMENDED CUTTING CONDITIONS

SIDE MILLING

Material	DC	n	Vc	f	ap	ae
P Mild steel, Carbon steel, Alloy steel (180 – 280HB),	4	9500	120	1400	6	1.2
	5	7600	120	1400	7.5	1.5
	6	6400	120	1400	9	1.8
	8	4800	120	1300	12	2.4
	10	3800	120	1200	15	3
	12	3200	120	1000	18	3.6
P Pre-hardened steel (≤45HRC), Alloy tool steel	4	5600	70	490	4	0.4
	5	4500	70	500	5	0.5
	6	3700	70	500	6	0.6
	8	2800	70	520	8	0.8
	10	2200	70	460	10	1
	12	1900	70	450	12	1
M Austenitic stainless steel, Ferritic and martensitic stainless steel,	4	6400	80	470	4	0.6
	5	5100	80	470	5	0.9
	6	4200	80	580	6	1.2
S Titanium alloy	8	3200	80	630	8	1.5
	10	2500	80	660	10	1.8
	12	2100	80	610	12	2.4
M Precipitation hardening stainless steel, Cobalt chromium alloy	4	5600	70	490	4	0.8
	5	4500	70	500	5	1
	6	3700	70	500	6	1.2
	8	2800	70	520	8	1.6
	10	2200	70	460	10	2
	12	1900	70	450	12	2.4
S Heat resistant alloy	4	2400	30	120	4	0.4
	5	1900	30	120	5	0.5
	6	1600	30	130	6	0.6
	8	1200	30	130	8	0.8
	10	950	30	140	10	1
	12	800	30	140	12	1.2

1/1

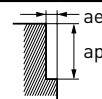

1. SMART MIRACLE coating has very low electrical conductivity; therefore, an external contact type of tool setter (electrically transmitted) may not work.
When measuring the tool length, please use an internal contact type (non-electrical type) or a laser tool setter.
2. When cutting austenitic stainless steels and titanium alloys, the use of water-soluble cutting fluid is effective.
3. If the depth of cut is shallow, the revolution and feed rate can be increased.
4. If the rigidity of the machine or the work materials installation is very low, or chattering and noise are generated, reduce the revolution and feed rate proportionately.

VQ4MVM

SLOT MILLING AND RAMPING

Material	DC	n	Vc	f	ap	ae	
P Mild steel, Carbon steel, Alloy steel (180 – 280HB)	4	8000	100	840	4	4	
	5	6400	100	840	5	5	
	6	5300	100	840	6	6	
	8	4000	100	740	8	8	
	10	3200	100	680	10	10	
	12	2700	100	570	12	12	
	Pre-hardened steel (≤45HRC), Alloy tool steel	4	4800	60	210	2	4
		5	3800	60	210	2.5	5
		6	3200	60	230	3	6
		8	2400	60	240	4	8
		10	1900	60	270	5	10
		12	1600	60	260	6	12
M Austenitic stainless steel, Ferritic and martensitic stainless steel, Titanium alloy	4	4800	60	280	4	4	
	5	3800	60	280	5	5	
	6	3200	60	300	6	6	
	8	2400	60	320	8	8	
	10	1900	60	350	10	10	
S Precipitation hardening stainless steel, Cobalt chromium alloy	4	4000	50	250	2	4	
	5	3200	50	250	2.5	5	
	6	2700	50	290	3	6	
	8	2000	50	260	4	8	
	10	1600	50	230	5	10	
S Heat resistant alloy	4	2000	25	93	1.2	4	
	5	1600	25	95	1.5	5	
	6	1300	25	96	1.8	6	
	8	990	25	100	2.4	8	
	10	800	25	120	3	10	
	12	660	25	110	3.6	12	

1/1

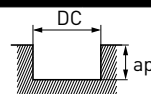

1. SMART MIRACLE coating has very low electrical conductivity; therefore, an external contact type of tool setter (electric transmitted) may not work.
When measuring the tool length, please use an internal contact type (non-electricity type) or a laser tool setter.
2. When cutting austenitic stainless steels and titanium alloys, the use of water-soluble cutting fluid is effective.
3. When performing machining with a strong ramping angle, a high clamping force tool holder is recommended.
4. When performing ramping deeper than the recommended depth of cut, please divide the process into multiple steps within the recommended depth of cut.
5. If the rigidity of the machine or the work materials installation is very low, or chattering and noise are generated, reduce the revolution and feed rate proportionately.

VQ4MVM

FEED RATE FACTOR FOR RAMPING

Material	DC	Slot milling feed %						
		1°	5°	10°	15°	20°	25°	30°
P Mild steel, Carbon steel, Alloy steel (180 – 280HB), Pre-hardened steel (≤45HRC), Alloy tool steel	4	100	90	80	80	60	60	60
	5	100	90	80	80	60	60	60
	6	100	90	80	80	60	60	60
	8	100	95	90	90	90	75	75
	10	100	95	95	95	90	80	80
	12	100	95	95	95	90	80	80
	4	80	70	60				
	5	80	70	60				
	6	80	70	60				
	8	70	60	50				
	10	70	60	50				
	12	70	60	50				
M Austenitic stainless steel, Ferritic and martensitic stainless steel, Titanium alloy	4	90	80	70	50			
	5	90	80	70	50			
	6	90	80	70	60			
	8	90	80	70	60			
	10	80	70	60	50			
	12	80	70	60	50			
M Precipitation hardening stainless steel, Cobalt chromium alloy	4	90	80	70	60	60		
	5	90	80	70	60	60		
	6	90	80	70	60	60		
	8	90	80	70	60	60		
	10	80	80	70	60	60		
	12	80	80	70	60	60		
S Heat resistant alloy	4	90	80					
	5	90	80					
	6	90	80					
	8	90	80					
	10	80	70					
	12	80	70					

1/1



1. SMART MIRACLE coating has very low electrical conductivity; therefore, an external contact type of tool setter (electric transmitted) may not work.
When measuring the tool length, please use an internal contact type (non-electrical type) or a laser tool setter.
2. When performing ramping, please use the feed rate shown on the previous page multiplied by the coefficient.
3. When cutting austenitic stainless steels and titanium alloys, the use of water-soluble cutting fluid is effective.
4. When performing machining with large ramping angles, a high clamping force tool holder is recommended.
Also, if the machine or workpiece material lacks rigidity, or if chipping occurs on the cutting edge, adjust the ramping angle and feed rate.
5. When performing ramping deeper than the recommended depth of cut, please divide the process into multiple steps within the recommended depth of cut.

NEW

MV1000 SERIES

SETTING A NEW STANDARD FOR TOOL LIFE

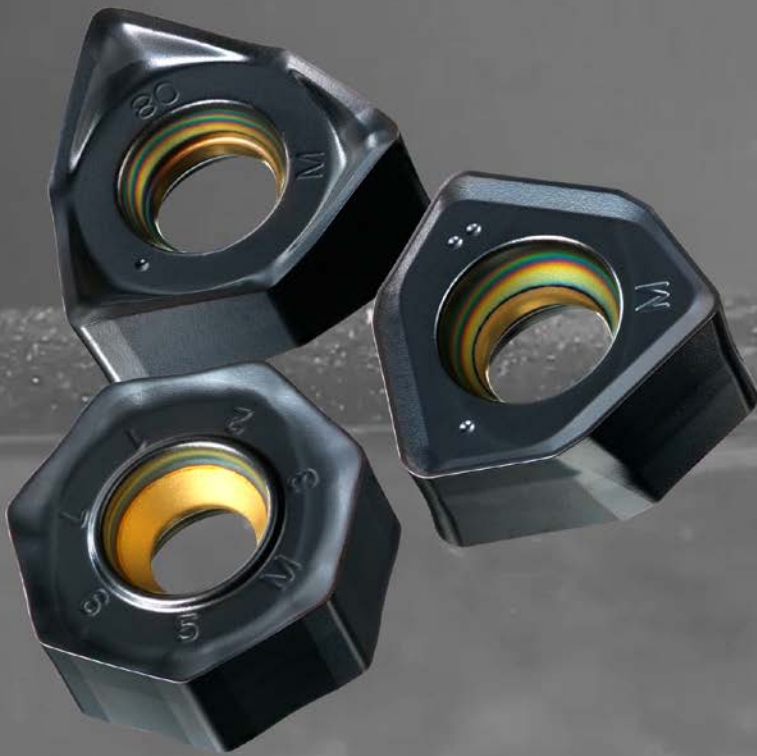

Interested in more...

B270

www.mhg-mediastore.net

DIA  **EDGE**

MV1000 SERIES

COATED CARBIDE GRADE FOR MILLING

ADVANCED WEAR RESISTANCE

By adopting the newly developed Al-Rich coating technology, the (Al,Ti)N with a high Al content ratio displays very high hardness. This greatly improves oxidation and wear resistance.

ADVANCED THERMAL SHOCK RESISTANCE

The extreme heat resistance of this new series achieves amazing stability, not only during dry cutting, but also when wet cutting where inserts are usually prone to thermal cracking.



Graphical representation

EXCELLENT WELDING RESISTANCE

Smooth surface.

OUTSTANDING WEAR RESISTANCE

Newly developed Al-Rich coating.

EXCELLENT CHIPPING RESISTANCE FOR STABLE MACHINING

Newly developed bonding layer.

FRACTURE RESISTANCE FOR THE ULTIMATE STABILITY

Exclusive cemented carbide substrate.



MV1000 SERIES

COMPLETE COATING TECHNOLOGY THAT REWRITES CURRENT TOOL LIFE STANDARDS

DUE TO THE NEWLY DEVELOPED AL-RICH COATING

Aluminium titanium nitride (Al,Ti)N is a compound of aluminium and titanium that is widely used as a coating for cutting tools due to its extremely hard and heat-resistant properties.

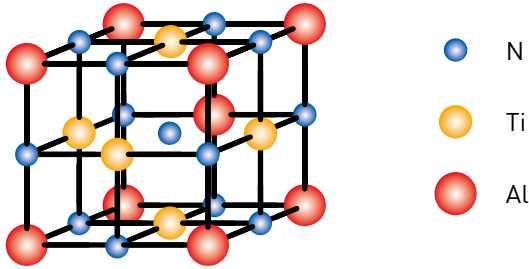

The combination of atoms with different sizes creates an exceptionally hard crystal structure.

The hardness of (Al,Ti)N increases as the Al content ratio increases, but with conventional technology, when the Al content ratio exceeds 60 %, the crystal structure changes and the hardness of (Al,Ti)N decreases.

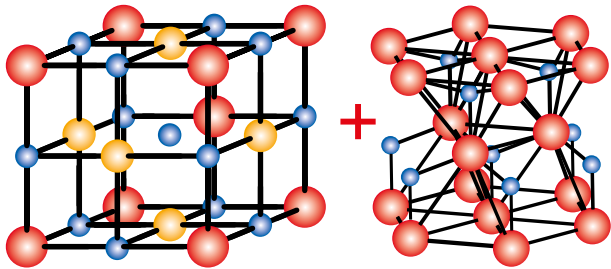

When the Al ratio is over 60 %, a softer crystal phase is formed.

Using a new coating process based on Mitsubishi Materials' own original technology. This way in which the Al-Rich coating does not change its crystal structure even when the Al content is increased. This enables a higher Al content and a provides a higher hardness (Al,Ti)N.

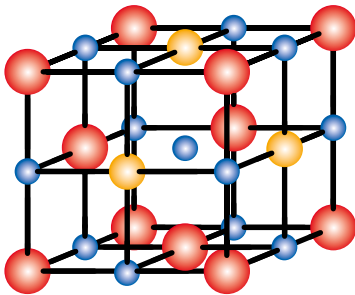

Crystal image of MV1000 series

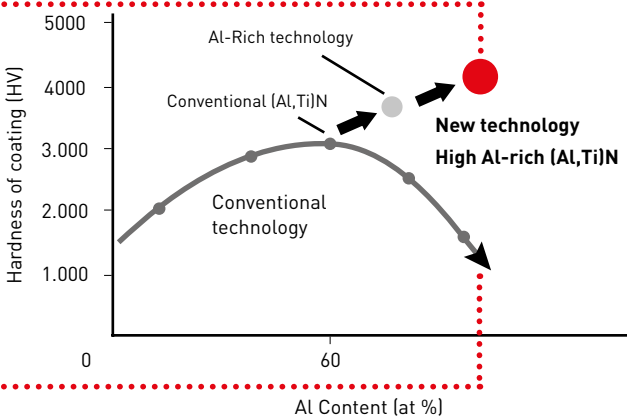
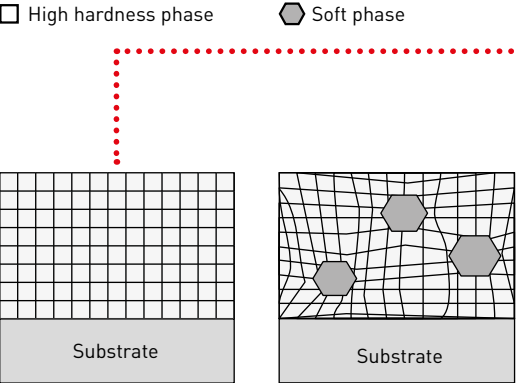

MV1020 / MV1030

COATED CARBIDE GRADE FOR MILLING

MV1020

This grade has advanced wear and thermal shock resistance and also achieves stable cutting at unprecedented cutting speeds, especially when machining steel and ductile cast iron, thus greatly reducing work time.

MV1030

The new Al-Rich coating also provides excellent wear resistance. An unprecedented performance against sudden breakage was also realised especially during problematic wet cutting and when machining stainless steels.

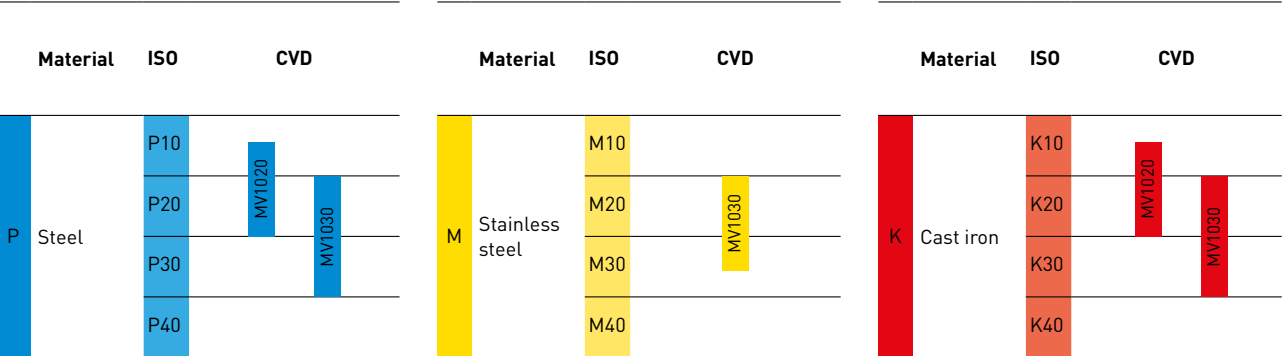

1. Dry cutting is recommended for machining stainless steel with MV1030.

MV1000 SERIES

CUTTING PERFORMANCE

MV1030

COMPARISON OF FRACTURE RESISTANCE FOR INTERMITTENT CUTTING OF ALLOY STEEL

MV1030 is capable of high feed machining due to its excellent fracture resistance even during interrupted cutting.

Material	DIN 41CrMo4
Tool	ASX445
Insert	SEMT13T3AGSN-JM
Vc (m/min)	200
ap (mm)	3.0
ae (mm)	100
Cutting mode	Dry cutting

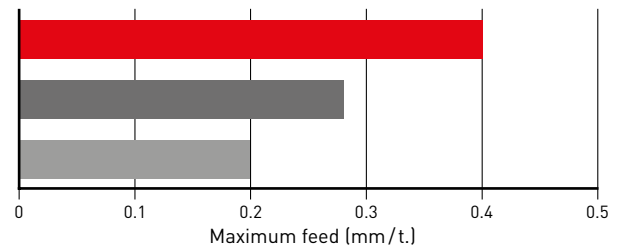

COMPARISON OF WEAR RESISTANCE WHEN MACHINING STAINLESS STEEL

MV1030 suppresses damage at the cut border and can be expected to significantly improve tool life.

Material	DIN X5CrNi189
Tool	ASX445
Insert	SEMT13T3AGSN-JM
Vc (m/min)	180
fz (mm/t)	0.2
ap (mm)	2.0
ae (mm)	100
Cutting mode	Dry cutting Single insert

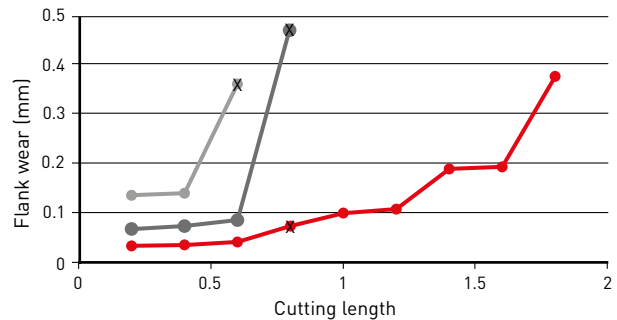

AFTER MACHINING 0.8 M



MV1030



Conventional A

AFTER MACHINING 0.6 M



Conventional B

MV1000 SERIES

CUTTING PERFORMANCE

MV1020

COMPARISON OF WEAR RESISTANCE WHEN MACHINING ALLOY STEEL

Material	DIN 41CrMo4
Tool	WWX400
Insert	6NMU1409080PNER-M
Vc (m/min)	300
fz (mm/t)	0.15
ap (mm)	3.0
ae (mm)	52
Cutting mode	Dry cutting Single insert

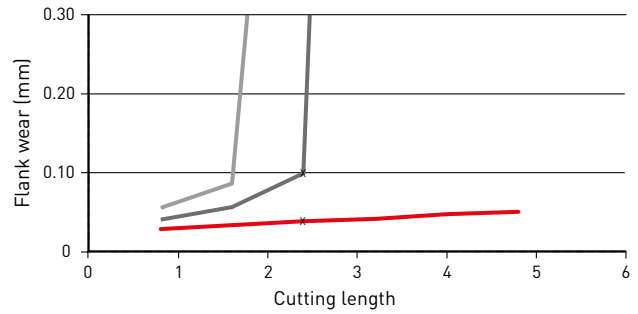

TAKEN AFTER CUTTING LENGTH OF 2.4 M



MV1020



Conventional A



Conventional B

COMPARISON OF WEAR RESISTANCE WHEN MACHINING DUCTILE CAST IRON

Material	DIN GGG70
Tool	WJX14
Insert	JOMU140715ZZER-M
Vc (m/min)	220
fz (mm/t)	1.0
ap (mm)	1.0
ae (mm)	45
Cutting mode	Dry cutting Single insert

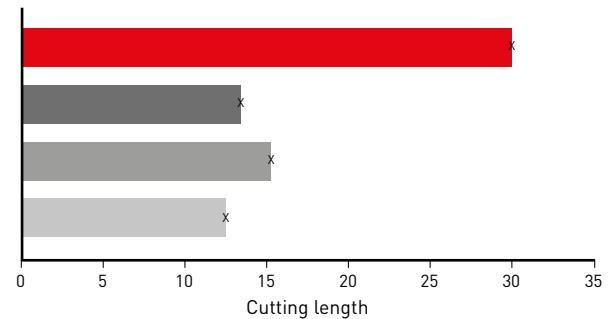

30.4 M



MV1020

13.6 M



Conventional A

15.2 M



Conventional B

12.8 M



Conventional C

MV1000 SERIES

CUTTING PERFORMANCE

MV1020

COMPARISON OF WEAR RESISTANCE WHEN MACHINING DUCTILE CAST IRON

Material	DIN GGG70
Tool	AHX440
Insert	NNMU130508ZEN-M
Vc (m/min)	300
fz (mm/t)	0.1
ap (mm)	2.0
ae (mm)	52
Cutting mode	Dry cutting Single insert

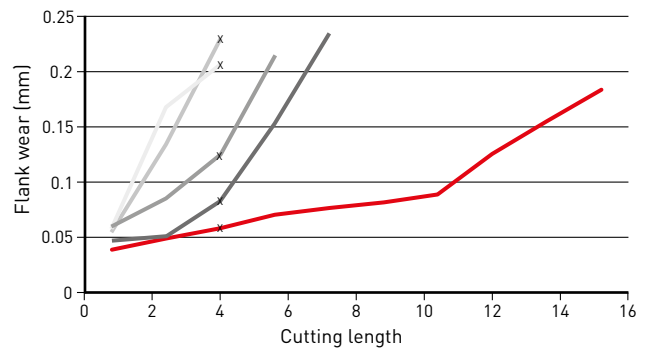

TAKEN AFTER CUTTING LENGTH OF 4.0 M

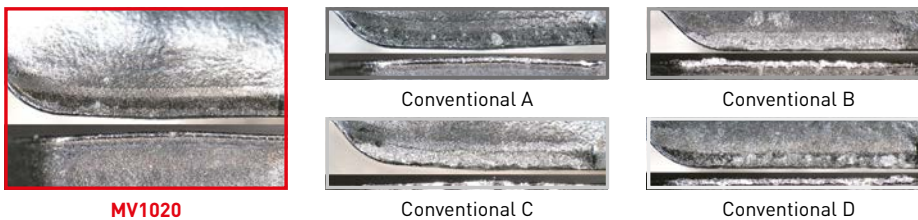

COMPARISON OF WEAR RESISTANCE WHEN MACHINING ALLOY STEEL

Material	DIN 41CrMo4
Tool	WSX445
Insert	SNMU140812ANER-M
Vc (m/min)	300
fz (mm/t)	0.2
ap (mm)	2.0
ae (mm)	100
Cutting mode	Dry cutting

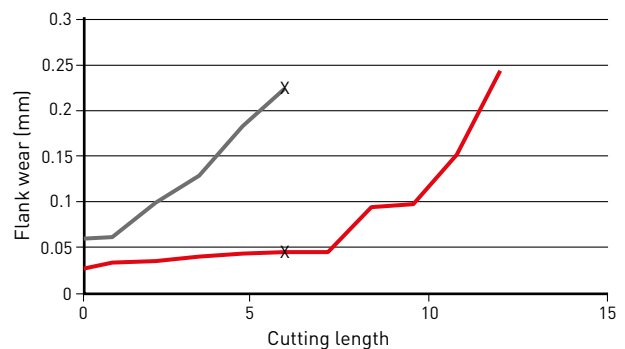

TAKEN AFTER CUTTING LENGTH OF 6.0 M

12 M CUTTING LENGTH ACHIEVED

CHIPPING OCCURS AT CUTTING LENGTH OF 6 M



MV1000 SERIES

CUTTING PERFORMANCE

MV1020

COMPARISON OF WEAR RESISTANCE FOR ROLLED STEEL

Material	DIN St 44-2
Tool	ASX445
Insert	SEMT13T3AGSN-JM
Vc (m/min)	300
fz (mm/t)	0.2
ap (mm)	2.0
ae (mm)	100
Cutting mode	Dry cutting

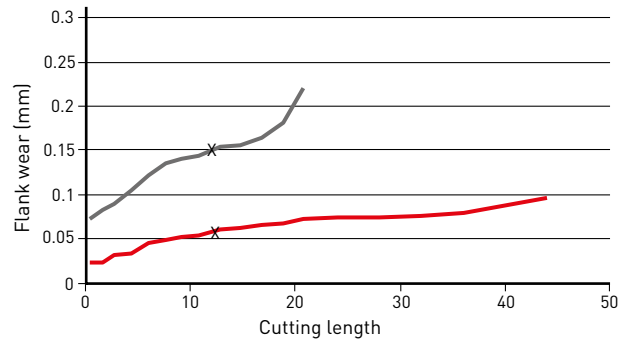

TAKEN AFTER CUTTING LENGTH OF 12.8 M

40 M CUTTING LENGTH ACHIEVED

WEAR PROGRESSED AND THE SUBSTRATE WAS EXPOSED



MV1020

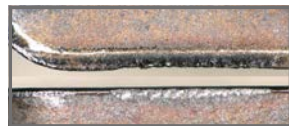

Conventional

COMPARISON OF WEAR RESISTANCE WHEN MACHINING CARBON STEEL

Material	DIN Ck55
Tool	ASX445
Insert	SEMT13T3AGSN-JM
Vc (m/min)	200
fz (mm/t)	0.2
ap (mm)	2.0
ae (mm)	100
Cutting mode	Wet cutting

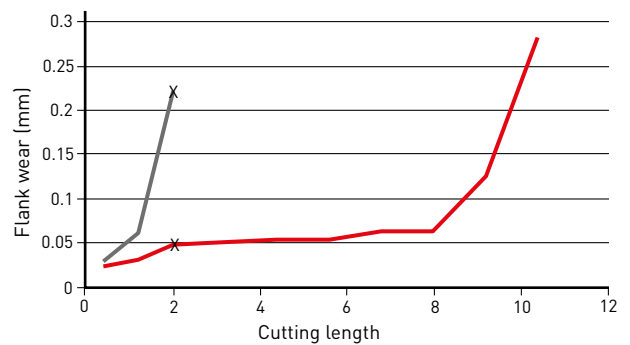

TAKEN AFTER CUTTING LENGTH OF 2.0 M

10 M CUTTING LENGTH ACHIEVED

CHIPPING OCCURRED DUE TO THERMAL CRACKS AT A CUTTING LENGTH OF 2 M



MV1020

..... Rake face

..... Main cutting edge

..... Wiper

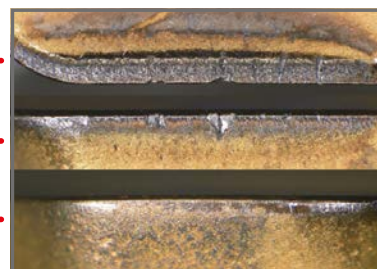

Conventional

MV1000 SERIES

CUTTING PERFORMANCE

MV1020

COMPARISON OF WEAR RESISTANCE WHEN MACHINING DUCTILE CAST IRON

Material	DIN GGG40.5
Tool	ASX445
Insert	SEMT13T3AGSN-JM
Vc (m/min)	250
fz (mm/t)	0.2
ap (mm)	2.0
ae (mm)	100
Cutting mode	Dry cutting

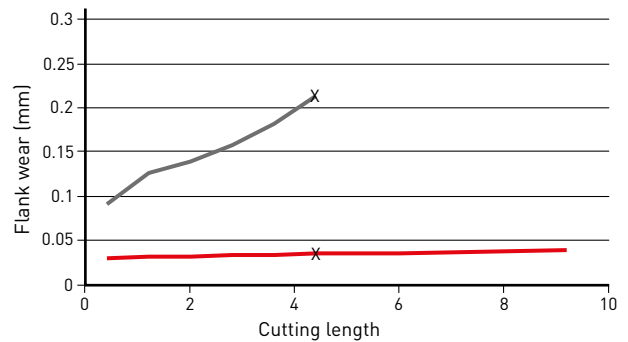

TAKEN AFTER CUTTING LENGTH OF 4.4 M

ACHIEVES A CUTTING LENGTH OF 9 M OR MORE

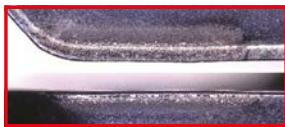

MV1020

UNABLE TO CONTINUE MACHINING AFTER A CUT LENGTH OF 4.4 M



Conventional

COMPARISON OF WEAR RESISTANCE WHEN MACHINING DUCTILE CAST IRON

WET CUTTING

Material	DIN GGG70
Tool	ASX445
Insert	SEMT13T3AGSN-JM
Vc (m/min)	200
fz (mm/t)	0.2
ap (mm)	2.0
ae (mm)	100
Cutting mode	Wet cutting

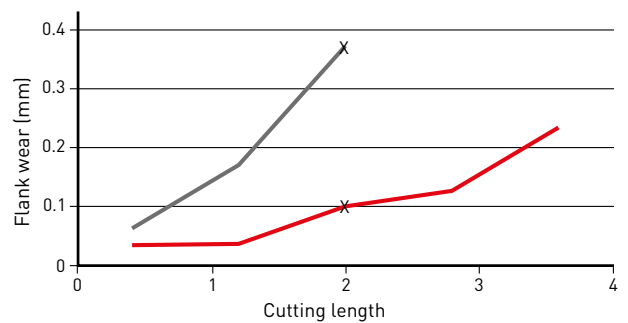

TAKEN AFTER CUTTING LENGTH OF 2.0 M

3.5 M CUTTING LENGTH ACHIEVED

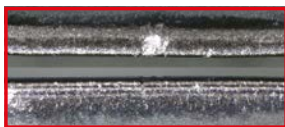

MV1020

UNABLE TO CONTINUE PROCESSING WITH A CUT LENGTH OF 2.0 M



Conventional

MV1000 SERIES

CUTTING PERFORMANCE

MV1020

COMPARISON OF WEAR RESISTANCE WHEN MACHINING DUCTILE CAST IRON

DRY CUTTING

Material	DIN GGG70
Tool	ASX445
Insert	SEMT13T3AGSN-JM
Vc (m/min)	200
fz (mm/t)	0.2
ap (mm)	2.0
ae (mm)	100
Cutting mode	Dry cutting

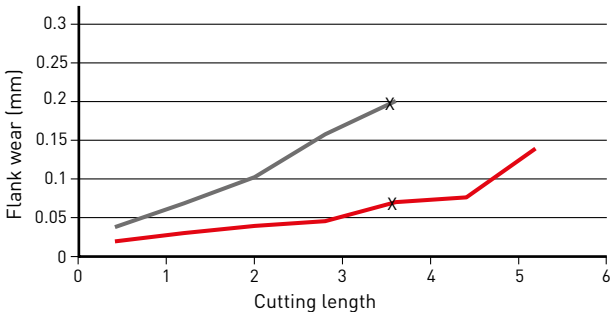

TAKEN AFTER CUTTING LENGTH OF 3.6 M

5.0 M CUTTING LENGTH ACHIEVED



MV1020

CHIPPING OCCURRED DUE TO PEELING OF THE COATING



Conventional

MV1000 SERIES

INSERTS

P	Steel	◆ ◆	Please note that the cutting conditions differ depending on multiple factors, for more details refer to the recommended cutting conditions.
M	Stainless steel	◆ ◆	
K	Cast iron	◆ ◆	

Honing:
E: Round

Order number	Application	Class	Honing	MV1020	MV1030	IC	S	S1	BS	RE/BCH	Geometry
6NMU0906040PNER-M	General purpose cutting	M	E	●		9.0	5.3	6.1	1.6	0.4	WWX200
6NMU0906080PNER-M	General purpose cutting	M	E	●		9.0	5.3	6.1	1.2	0.8	
6NMU0906080PNER-R	Cutting edge strength	M	E	●		9.0	5.3	6.1	1.2	0.8	
6NGU1409040PNER-L	Low cutting resistance	G	E	●	●	14.0	7.0	9.0	1.7	0.4	WWX400
6NGU1409080PNER-L	Low cutting resistance	G	E	●	●	14.0	7.0	9.0	1.3	0.8	
6NGU1409040PNER-M	General purpose cutting	G	E	●	●	14.0	7.0	9.0	1.7	0.4	
6NGU1409080PNER-M	General purpose cutting	G	E	●	●	14.0	7.0	9.0	1.3	0.8	
6NMU1409040PNER-M	General purpose cutting	M	E	●	●	14.0	7.0	9.0	1.7	0.4	
6NMU1409080PNER-M	General purpose cutting	M	E	●	●	14.0	7.0	9.0	1.3	0.8	
6NMU1409160PNER-M	General purpose cutting	M	E	●	●	14.0	7.0	9.0	0.5	1.6	
6NMU1409200PNER-M	General purpose cutting	M	E	●	●	14.0	7.0	9.0	0.5	2.0	
6NMU1409080PNER-R	Cutting edge strength	M	E	●	●	14.0	7.0	9.0	1.3	0.8	
6NMU1409160PNER-R	Cutting edge strength	M	E	●	●	14.0	7.0	9.0	0.5	1.6	
6NMU1409200PNER-R	Cutting edge strength	M	E	●	●	14.0	7.0	9.0	0.5	2.0	
SNGU140812ANER-L	Low cutting resistance	G	E	●	●	14.0	8.4	—	1.5	1.2	WSX445
SNGU140812ANER-M	General purpose cutting	G	E	●	●	14.0	8.4	—	1.5	1.2	
SNMU140812ANER-M	General purpose cutting	M	E	●	●	14.0	8.4	—	1.5	1.2	
SNMU140812ANER-R	Cutting edge strength	M	E	●	●	14.0	8.4	—	1.5	1.2	
SNMU140812ANER-H	Cutting edge strength	M	E	●	●	14.0	8.4	—	1.5	1.2	
JOMU090512ZZER-L	Low cutting resistance	M	E	●	●	9.525	4.73	—	0.88	1.2	WJX
JOMU140715ZZER-L	Low cutting resistance	M	E	●	●	14.0	6.58	—	1.3	1.5	
JOMU090512ZZER-M	General purpose cutting	M	E	●	●	9.525	4.75	—	0.88	1.2	
JOMU140715ZZER-M	General purpose cutting	M	E	●	●	14.0	6.63	—	1.3	1.5	
JOMU090512ZZER-R	Cutting edge strength	M	E	●	●	9.525	4.83	—	0.88	1.2	
JOMU140715ZZER-R	Cutting edge strength	M	E	●	●	14.0	6.75	—	1.3	1.5	
SNMU1206C05ZNER-M	Cast iron milling	M	E	●	●	12.7	6.2	—	1.6	0.5	WSF406W













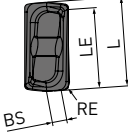

1/3

(10 inserts in one case)

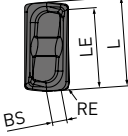

MV1000 SERIES – INSERTS

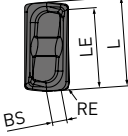
P	Steel	◆ ◆	Please note that the cutting conditions differ depending on multiple factors, for more details refer to the recommended cutting conditions. Honing: E: Round
M	Stainless steel	◆ ◆	
K	Cast iron	◆ ◆	

Order number	Application	Class	Honing	MV1020	MV1030	L	S	LE	BS	RE	Geometry
LOGU0904020PNER-L	Low cutting resistance	G	E	●	●	8.7	4.3	7.6	1.7	0.2	VPX200    
LOGU0904040PNER-L		G	E	●	●	8.7	4.3	7.6	1.5	0.4	
LOGU0904080PNER-L		G	E	●	●	8.7	4.3	7.6	1.2	0.8	
LOGU0904100PNER-L		G	E	●	●	8.7	4.3	7.6	1.0	1.0	
LOGU0904120PNER-L		G	E	●	●	8.7	4.3	7.6	0.8	1.2	
LOGU0904160PNER-L		G	E	●	●	8.7	4.3	7.6	0.5	1.6	
LOGU0904020PNER-M	General purpose cutting	G	E	●	●	8.7	4.3	7.6	1.7	0.2	VPX300    
LOGU0904040PNER-M		G	E	●	●	8.7	4.3	7.6	1.6	0.4	
LOGU0904080PNER-M		G	E	●	●	8.7	4.3	7.6	1.2	0.8	
LOGU0904100PNER-M		G	E	●	●	8.7	4.3	7.6	1.0	1.0	
LOGU0904120PNER-M		G	E	●	●	8.7	4.3	7.6	0.9	1.2	
LOGU0904160PNER-M		G	E	●	●	8.7	4.3	7.6	0.5	1.6	
LOGU1207020PNER-L	Low cutting resistance	G	E	●	●	12.4	7.0	11.3	3.0	0.2	VPX300    
LOGU1207040PNER-L		G	E	●	●	12.4	7.0	11.3	2.8	0.4	
LOGU1207080PNER-L		G	E	●	●	12.4	7.0	11.3	2.6	0.8	
LOGU1207100PNER-L		G	E	●	●	12.4	7.0	11.3	2.5	1.0	
LOGU1207120PNER-L		G	E	●	●	12.4	7.0	11.3	2.4	1.2	
LOGU1207160PNER-L		G	E	●	●	12.4	7.0	11.3	1.8	1.6	
LOGU1207200PNER-L		G	E	●	●	12.4	7.0	11.3	1.4	2.0	
LOGU1207240PNER-L		G	E	●	●	12.4	7.0	11.3	1.2	2.4	
LOGU1207300PNER-L		G	E	●	●	12.4	7.0	11.3	0.6	3.0	
LOGU1207320PNER-L		G	E	●	●	12.4	7.0	11.3	0.4	3.2	
LOGU1207020PNER-M	General purpose cutting	G	E	●	●	12.4	7.0	11.3	3.0	0.2	VPX300    
LOGU1207040PNER-M		G	E	●	●	12.4	7.0	11.3	2.8	0.4	
LOGU1207080PNER-M		G	E	●	●	12.4	7.0	11.3	2.4	0.8	
LOGU1207100PNER-M		G	E	●	●	12.4	7.0	11.3	2.3	1.0	
LOGU1207120PNER-M		G	E	●	●	12.4	7.0	11.3	2.1	1.2	
LOGU1207160PNER-M		G	E	●	●	12.4	7.0	11.3	1.7	1.6	
LOGU1207200PNER-M		G	E	●	●	12.4	7.0	11.3	1.4	2.0	
LOGU1207240PNER-M		G	E	●	●	12.4	7.0	11.3	1.0	2.4	
LOGU1207300PNER-M		G	E	●	●	12.4	7.0	11.3	0.5	3.0	
LOGU1207320PNER-M		G	E	●	●	12.4	7.0	11.3	0.3	3.2	

2/3

(10 inserts in one case)



MV1000 SERIES – INSERTS

P	Steel	◆ ◆	Please note that the cutting conditions differ depending on multiple factors, for more details refer to the recommended cutting conditions. Honing: E: Round S: Chamfer + round
M	Stainless steel	◆ ◆	
K	Cast iron	◆ ◆	

Order number	Application	Class	Honing	Honing		IC	S	S1	BS	RE	Geometry
				MV1020	MV1030						
NNMU130508ZER-L	Low cutting resistance	M	E	●	●	13.4	5.77	—	1.0	0.8	AHX440/475
NNMU130508ZEN-M	General purpose cutting	M	E	●	●	13.4	5.57	—	1.0	0.8	
NNMU130532ZEN-M	General purpose cutting	M	E	●	●	13.4	5.57	—	—	3.2	
NNMU130532ZEN-R	Cutting edge strength	M	E	●	●	13.4	5.47	—	—	3.2	
SEET13T3AGEN-JL	Finish-light cutting	E	E	●	●	13.4	3.97	—	1.9	1.5	ASX445
SEMT13T3AGSN-JM	Light-rough cutting	M	S	●	●	13.4	3.97	—	1.9	1.5	
SEMT13T3AGSN-JH	Medium-heavy cutting	M	S	●	●	13.4	3.97	—	1.9	1.5	
SEMT13T3AGSN-FT	Cast iron milling	M	S	●	●	13.4	3.97	—	1.9	1.5	
SOET12T308PEER-JL	Finish-light cutting	E	E	●	●	12.7	3.97	—	1.4	0.8	ASX400
SOMT12T308PEER-JM	Light-rough cutting	M	E	●	●	12.7	3.97	—	1.4	0.8	
SOMT12T308PEER-JH	Medium-heavy cutting	M	E	●	●	12.7	3.97	—	1.4	0.8	
SOMT12T320PEER-FT	Heavy interrupted cutting	M	E	●	●	12.7	3.97	—	0.5	2.0	

3/3

(10 inserts in one case)



MV1000 SERIES

COATED CARBIDE GRADE FOR MILLING

COVERS A WIDE RANGE OF CUTTING SPEEDS (DRY CUTTING WITH WWX400)

Material	Properties	Grade	Vc
P Mild steel Carbon steel Alloy steel	≤180HB	MV1020	305 (250 – 360)
		MV1030	235 (190 – 280)
		MP6120	245 (200 – 290)
		MP6130	235 (190 – 280)
	180–280HB 280–350HB	MV1020	260 (210 – 310)
		MV1030	200 (155 – 245)
		MP6120	205 (160 – 250)
		MP6130	200 (155 – 245)
		MV1020	260 (210 – 310)
		MV1030	200 (155 – 245)
		MP6120	200 (155 – 245)
		MP6130	195 (150 – 240)
M Stainless steel	>200HB	MV1030	180 (155 – 200)
		MP7130	175 (150 – 200)
		VP15TF	175 (150 – 200)
K Ductile cast iron	Tensile strength ≤450MPa	MV1020	255 (200 – 310)
		MV1030	205 (160 – 250)
		MP6120	205 (160 – 250)
		MP6130	205 (160 – 250)
	Tensile strength >450MPa	MV1020	225 (160 – 290)
		MV1030	170 (130 – 210)
		MP6120	170 (130 – 210)
		MP6130	170 (130 – 210)

1/1

MV1000 SERIES

RECOMMENDED CUTTING CONDITIONS

WWX200/400

CUTTING SPEED (DRY CUTTING)

Material	Properties	Conditions	MV1020			MV1030		
			ae			ae		
			≥0.5 DC	≥0.8 DC	DC (Slot)	≥0.5 DC	≥0.8 DC	DC (Slot)
			Vc			Vc		
P	Mild steel ≤180HB	●	300 [250-350]	280 [230-330]	250 [200-300]	230 [190-270]	210 [170-250]	190 [150-230]
		●	290 [240-340]	260 [210-320]	240 [190-290]	230 [190-270]	210 [170-250]	190 [150-230]
P	Carbon steel Alloy steel 180-350HB	●	260 [210-310]	240 [190-280]	210 [160-260]	200 [160-240]	180 [140-220]	160 [120-200]
		●	250 [200-300]	230 [180-270]	200 [150-250]	200 [160-240]	180 [140-220]	160 [120-200]
M	Stainless steel —	●	—	—	—	180 [160-200]	160 [140-180]	—
		●	—	—	—	170 [150-190]	150 [130-170]	—
K	Ductile cast iron	●	240 [200-310]	220 [170-280]	200 [150-260]	210 [170-250]	190 [150-230]	170 [130-210]
		●	230 [190-300]	210 [160-270]	190 [140-250]	210 [170-250]	190 [150-230]	170 [130-210]
		●	210 [160-280]	190 [140-250]	160 [120-210]	170 [130-210]	150 [110-190]	130 [90-170]
		●	200 [150-270]	180 [130-240]	150 [110-200]	170 [130-210]	150 [110-190]	130 [90-170]

1/1

WWX200/400

CUTTING SPEED (WET CUTTING)

Material	Properties	Conditions	MV1020			MV1030		
			ae			ae		
			≥0.5 DC	≥0.8 DC	DC (Slot)	≥0.5 DC	≥0.8 DC	DC (Slot)
			Vc			Vc		
P	Mild steel ≤180HB	●	220 [210-230]	190 [180-210]	180 [160-190]	140 [130-150]	120 [110-130]	110 [100-120]
		●	210 [200-220]	180 [170-200]	170 [150-180]	140 [130-150]	120 [110-130]	110 [100-120]
P	Carbon steel Alloy steel 180-350HB	●	200 [190-210]	170 [160-190]	160 [150-170]	140 [130-150]	120 [110-130]	110 [100-120]
		●	190 [180-200]	160 [150-180]	150 [140-160]	140 [130-150]	120 [110-130]	110 [100-120]
K	Ductile cast iron	●	200 [180-240]	180 [150-220]	150 [130-200]	160 [140-180]	140 [120-160]	120 [100-140]
		●	190 [170-230]	170 [140-210]	140 [120-190]	160 [140-180]	140 [120-160]	120 [100-140]
		●	180 [170-210]	160 [150-190]	140 [120-160]	150 [140-160]	130 [120-140]	110 [100-120]
		●	170 [160-200]	150 [140-180]	120 [110-150]	150 [140-160]	130 [120-140]	110 [100-120]

1/1

1. The recommended cutting speed has been calculated for a depth of cut 2 mm. Please reduce the cutting speed by an appropriate amount corresponding to the increase in cutting depth.



MV1000 SERIES

RECOMMENDED CUTTING CONDITIONS

WWX200

DEPTH OF CUT / FEED PER TOOTH

DRY AND WET CUTTING

Material	Properties	Conditions	ae						
			≥0.5 DC		≥0.8 DC		DC (Slot)		
				ap fz		ap fz		ap fz	
P	Mild steel	≤180HB	●●	L, M	≤3.0 0.13 [0.10-0.15]	L, M	≤3.0 0.13 [0.10-0.15]	L, M	≤2.0 0.13 [0.10-0.15]
			●	M,R	≤3.0 0.16 [0.10-0.20]	M,R	≤3.0 0.16 [0.10-0.20]	—	—
	Carbon steel Alloy steel	180-350HB	●●	L, M	≤3.0 0.13 [0.10-0.15]	L, M	≤3.0 0.13 [0.10-0.15]	L, M	≤2.0 0.13 [0.10-0.15]
			●	M,R	≤3.0 0.16 [0.10-0.20]	M,R	≤3.0 0.16 [0.10-0.20]	—	—
K	Ductile cast iron	Tensile strength ≤450MPa	●●	L, M	≤3.0 0.13 [0.10-0.15]	L, M	≤3.0 0.13 [0.10-0.15]	L, M	≤2.0 0.13 [0.10-0.15]
			●	M,R	≤3.0 0.16 [0.10-0.20]	M,R	≤3.0 0.16 [0.10-0.20]	—	—
	Ductile cast iron	Tensile strength ≤800MPa	●●	L, M	≤3.0 0.13 [0.10-0.15]	L, M	≤3.0 0.13 [0.10-0.15]	L, M	≤2.0 0.13 [0.10-0.15]
			●	M,R	≤3.0 0.16 [0.10-0.20]	M,R	≤3.0 0.16 [0.10-0.20]	—	—



1/1

1. Refer to the above table and set up cutting conditions according to the application.

WWX400

DEPTH OF CUT / FEED PER TOOTH

DRY AND WET CUTTING

Material	Properties	Conditions	ae						
			≥0.5 DC		≥0.8 DC		DC (Slot)		
				ap fz		ap fz		ap fz	
P	Mild steel	≤180HB	●●	L, M	≤4.0 0.13 [0.10-0.15]	L, M	≤3.0 0.13 [0.10-0.15]	L, M	≤2.0 0.13 [0.10-0.15]
			●	M,R	≤4.0 0.16 [0.10-0.20]	M,R	≤3.0 0.16 [0.10-0.20]	—	—
	Carbon steel Alloy steel	180-350HB	●●	L, M	≤4.0 0.13 [0.10-0.15]	L, M	≤3.0 0.13 [0.10-0.15]	L, M	≤2.0 0.13 [0.10-0.15]
			●	M,R	≤4.0 0.16 [0.10-0.20]	M,R	≤3.0 0.16 [0.10-0.20]	—	—
M	Stainless steel	—	●●	L, M	≤2.0 0.13 [0.10-0.15]	L, M	≤2.0 0.13 [0.10-0.15]	—	—
K	Ductile cast iron	Tensile strength ≤450MPa	●●	L, M	≤4.0 0.13 [0.10-0.15]	L, M	≤3.0 0.13 [0.10-0.15]	L, M	≤2.0 0.13 [0.10-0.15]
			●	M,R	≤4.0 0.16 [0.10-0.20]	M,R	≤3.0 0.16 [0.10-0.20]	—	—
	Ductile cast iron	Tensile strength ≤800MPa	●●	L, M	≤4.0 0.13 [0.10-0.15]	L, M	≤3.0 0.13 [0.10-0.15]	L, M	≤2.0 0.13 [0.10-0.15]
			●	M,R	≤4.0 0.16 [0.10-0.20]	M,R	≤3.0 0.16 [0.10-0.20]	—	—

1/1

1. Refer to the above table and set up cutting conditions according to the application.

MV1000 SERIES

RECOMMENDED CUTTING CONDITIONS

WSX445

CUTTING SPEED

DRY AND WET CUTTING











Material	Properties	MV1020		MV1030		
		Vc		Vc		
		Dry cutting	Wet cutting	Dry cutting	Wet cutting	
P	Mild steel	≤180HB	300 (200 – 400)	220 (120 – 320)	250 (200 – 300)	150 (100 – 200)
	Carbon steel	180–350HB	260 (170 – 350)	200 (100 – 300)	220 (170 – 270)	120 (80 – 160)
	Alloy steel	280–350HB	180 (100 – 250)	150 (100 – 200)	180 (100 – 250)	120 (80 – 160)
M	Stainless steel	—	—	—	200 (150 – 250)	—
K	Ductile cast iron	Tensile strength ≤450MPa	240 (130 – 350)	200 (130 – 250)	160 (110 – 240)	150 (100 – 200)
		Tensile strength ≤800MPa	220 (80 – 350)	180 (80 – 230)	180 (110 – 250)	140 (80 – 200)

1/1

WSX445

DEPTH OF CUT / FEED PER TOOTH

DRY AND WET CUTTING

Material	Properties											
												
		fz	ap	fz	ap	fz	ap	fz	ap	fz	ap	
P	Mild steel	≤180HB	0.15 (0.1–0.2)	≤1.0	0.15 (0.1–0.2)	≤2.0	0.2 (0.15–0.25)	≤3.0	0.2 (0.15–0.25)	≤4.0	0.25 (0.2–0.3)	≤5.0
	Carbon steel	180–350HB	0.15 (0.1–0.2)	≤1.0	0.15 (0.1–0.2)	≤2.0	0.2 (0.15–0.25)	≤3.0	0.2 (0.15–0.25)	≤4.0	0.25 (0.2–0.3)	≤5.0
	Alloy steel	280–350HB	0.15 (0.1–0.2)	≤1.0	0.15 (0.1–0.2)	≤2.0	0.2 (0.15–0.25)	≤3.0	0.2 (0.15–0.25)	≤4.0	0.25 (0.2–0.3)	≤5.0
M	Stainless steel	—	0.15 (0.1–0.2)	≤1.0	0.15 (0.1–0.2)	≤2.0	0.2 (0.15–0.25)	≤3.0	—	—	—	—
K	Ductile cast iron	Tensile strength ≤450MPa	0.15 (0.1–0.2)	≤1.0	0.15 (0.1–0.2)	≤2.0	0.2 (0.15–0.25)	≤3.0	0.2 (0.15–0.25)	≤4.0	0.25 (0.2–0.3)	≤5.0
		Tensile strength ≤800MPa	0.15 (0.1–0.2)	≤1.0	0.15 (0.1–0.2)	≤2.0	0.2 (0.15–0.25)	≤3.0	0.2 (0.15–0.25)	≤4.0	0.25 (0.2–0.3)	≤5.0

1/1

MV1000 SERIES

RECOMMENDED CUTTING CONDITIONS

CHIPBREAKER SELECTION TABLE

WJX09

Material	Properties	L		M		R	
		Conditions	ap	Conditions	ap	Conditions	ap
P	Mild steel	● ●	≤1.0	● ●	≤1.5	● ✖	≤1.5
	Carbon steel, Alloy steel	● ●	≤1.0	● ●	≤1.5	● ✖	≤1.5
M	Stainless steel	● ●	≤1.0	● ●	≤1.0	—	—
K	Ductile cast iron	● ●	≤1.0	● ●	≤1.5	● ✖	≤1.5
		● ●	≤1.0	● ●	≤1.0	● ✖	≤1.0

1/1

WJX14

Material	Properties	L		M		R	
		Conditions	ap	Conditions	ap	Conditions	ap
P	Mild steel	● ●	≤2.0	● ●	≤3.0	● ✖	≤3.0
	Carbon steel, Alloy steel	● ●	≤2.0	● ●	≤3.0	● ✖	≤3.0
M	Stainless steel	● ●	≤2.0	● ●	≤1.5	—	—
K	Ductile cast iron	● ●	≤2.0	● ●	≤3.0	—	—
		● ●	≤2.0	● ●	≤2.0	—	—

1/1

MV1000 SERIES

RECOMMENDED CUTTING CONDITIONS

WJX09

CUTTING SPEED (DRY CUTTING)

Material	Properties	MV1020	MV1030	
		Vc	Vc	
P	Mild steel	≤180HB	230 (180 – 280)	160 (100 – 220)
	Carbon steel, Alloy steel	180–350HB	220 (170 – 270)	150 (80 – 220)
M	Stainless steel	≤200HB	—	160 (130 – 200)
		>200HB	—	140 (80 – 200)
K	Ductile cast iron	Tensile strength ≤450MPa	210 (160 – 260)	160 (120 – 210)
		Tensile strength ≤800MPa	190 (140 – 240)	130 (90 – 170)

1/1

WJX09

DEPTH OF CUT / FEED PER TOOTH

DRY CUTTING

Material	Properties	 ap	DCX = 25, 28 (Z=2)	DCX = 25, 28 (Z=3)	DCX ≥ 32	
			fz	fz	fz	
P	Mild steel	M, R	≤0.5	1.3 (0.4 – 2.0)	1.3 (0.4 – 2.0)	1.5 (0.5 – 2.0)
			≤1.0	1.0 (0.3 – 1.3)	0.8 (0.3 – 1.0)	1.2 (0.4 – 1.5)
			≤1.5	0.6 (0.3 – 1.0)	—	0.8 (0.4 – 1.2)
		L	≤0.5	1.2 (0.4 – 1.6)	1.2 (0.4 – 1.6)	1.2 (0.4 – 1.6)
			≤1.0	0.8 (0.3 – 1.2)	0.8 (0.3 – 1.0)	1.0 (0.4 – 2.5)
			≤0.5	1.3 (0.4 – 1.7)	1.3 (0.4 – 1.7)	1.5 (0.4 – 2.0)
M	Carbon steel Alloy steel	M, R	≤1.0	0.8 (0.3 – 1.0)	0.7 (0.3 – 0.9)	1.0 (0.3 – 1.3)
			≤1.5	0.5 (0.3 – 0.7)	—	0.7 (0.3 – 1.0)
			≤0.5	1.2 (0.3 – 1.5)	1.2 (0.3 – 1.5)	1.2 (0.3 – 1.5)
		L	≤1.0	0.7 (0.2 – 1.0)	0.7 (0.2 – 0.9)	0.7 (0.2 – 1.0)
			≤0.5	0.8 (0.3 – 1.0)	0.8 (0.3 – 1.0)	0.8 (0.3 – 1.0)
			≤1.0	1.0 (0.4 – 1.2)	1.0 (0.4 – 1.2)	1.0 (0.4 – 1.2)
K	Stainless steel	M	≤0.5	0.6 (0.2 – 0.8)	0.6 (0.2 – 0.8)	0.6 (0.2 – 0.8)
			≤1.0	0.8 (0.3 – 1.0)	0.8 (0.3 – 1.0)	0.8 (0.3 – 1.0)
			≤0.5	1.3 (0.4 – 1.7)	1.3 (0.4 – 1.7)	1.5 (0.4 – 2.0)
		M, R	≤1.0	0.8 (0.3 – 1.0)	0.7 (0.3 – 0.9)	1.0 (0.3 – 1.3)
			≤1.5	0.5 (0.3 – 0.7)	—	0.7 (0.3 – 1.0)
			≤0.5	1.0 (0.3 – 1.3)	1.0 (0.3 – 1.3)	1.0 (0.3 – 1.3)
K	Ductile cast iron	L	≤1.0	0.8 (0.2 – 1.0)	0.7 (0.2 – 0.9)	0.8 (0.2 – 1.2)
			≤0.5	1.0 (0.2 – 1.5)	1.0 (0.2 – 1.5)	1.3 (0.3 – 1.7)
			≤1.0	0.8 (0.2 – 1.0)	0.6 (0.2 – 0.8)	1.0 (0.3 – 1.2)
		M, R	≤0.5	0.8 (0.3 – 1.2)	0.8 (0.3 – 1.2)	0.8 (0.3 – 1.2)
			≤1.0	0.5 (0.2 – 0.8)	0.5 (0.2 – 0.8)	0.5 (0.2 – 0.8)
			≤0.5	0.5 (0.2 – 0.8)	0.5 (0.2 – 0.8)	0.5 (0.2 – 0.8)

1/1

1. To discharge chips effectively, use an air blow when machining. When the air blow is less effective at discharging chips, we recommend wet cutting.
2. When wet cutting, tool life may become shorter than dry cutting. When carrying out wet cutting for the applications recommended with dry cutting, reduce the cutting speed by 25 %.
3. When large vibration occurs, reduce the cutting conditions.
4. For interrupted cutting, reduce the cutting speed and feed rate by 20 %.

MV1000 SERIES

RECOMMENDED CUTTING CONDITIONS

WJX14

CUTTING SPEED (DRY CUTTING)

Material	Properties	MV1020	MV1030
		Vc	Vc
P	Mild steel	220 (170 – 270)	130 (80 – 180)
	Carbon steel, Alloy steel	200 (150 – 250)	120 (60 – 180)
M	Stainless steel	—	160 (130 – 200)
		—	140 (100 – 200)
K	Ductile cast iron	200 (150 – 250)	150 (100 – 200)
		180 (130 – 230)	120 (80 – 160)



MV1000 SERIES

RECOMMENDED CUTTING CONDITIONS

WJX14

DEPTH OF CUT / FEED PER TOOTH

DRY CUTTING

Material	Properties	 ap	DCX = 50, 52		DCX ≥ 63
			fz		fz
P Mild steel	≤180HB	M, R	≤1.0	1.5 [0.6 – 2.5]	1.7 [0.6 – 2.8]
			≤1.5	1.3 [0.6 – 2.0]	1.5 [0.6 – 2.5]
			≤2.0	1.2 [0.6 – 2.0]	1.3 [0.6 – 2.5]
			≤2.5	0.8 [0.3 – 1.5]	1.0 [0.3 – 1.6]
			≤3.0	0.4 [0.2 – 1.0]	0.5 [0.2 – 1.2]
		L	≤1.0	1.2 [0.4 – 2.0]	1.2 [0.4 – 2.0]
			≤1.5	1.0 [0.4 – 1.8]	1.0 [0.4 – 2.5]
			≤2.0	0.8 [0.4 – 1.7]	0.8 [0.4 – 1.7]
			≤1.0	1.5 [0.5 – 2.0]	1.7 [0.5 – 2.5]
			≤1.5	1.2 [0.5 – 1.7]	1.3 [0.5 – 2.2]
M Carbon steel Alloy steel	180–350HB	M, R	≤2.0	1.0 [0.5 – 1.5]	1.2 [0.5 – 2.0]
			≤2.5	0.7 [0.3 – 1.2]	0.9 [0.3 – 1.5]
			≤3.0	0.3 [0.2 – 0.8]	0.4 [0.2 – 1.0]
			≤1.0	1.0 [0.3 – 1.7]	1.0 [0.3 – 1.7]
			≤1.5	0.8 [0.3 – 1.5]	0.8 [0.3 – 1.5]
		L	≤2.0	0.7 [0.3 – 1.2]	0.7 [0.3 – 1.2]
			≤1.0	1.0 [0.5 – 1.2]	1.0 [0.5 – 1.2]
			≤1.5	1.0 [0.5 – 1.0]	1.0 [0.5 – 1.0]
			≤1.0	0.8 [0.3 – 1.2]	0.8 [0.3 – 1.2]
			≤1.5	0.8 [0.3 – 1.0]	0.8 [0.3 – 1.0]
M Stainless steel	≤200HB	M	≤1.0	1.0 [0.5 – 1.2]	1.0 [0.5 – 1.2]
			≤1.5	1.0 [0.5 – 1.0]	1.0 [0.5 – 1.0]
		L	≤1.0	0.8 [0.3 – 1.2]	0.8 [0.3 – 1.2]
			≤1.5	0.8 [0.3 – 1.0]	0.8 [0.3 – 1.0]
			≤1.5	0.8 [0.3 – 1.0]	0.8 [0.3 – 1.0]
	>200HB	M	≤1.0	1.0 [0.5 – 1.2]	1.0 [0.5 – 1.2]
			≤1.5	1.0 [0.5 – 1.0]	1.0 [0.5 – 1.0]
		L	≤1.0	0.8 [0.3 – 1.2]	0.8 [0.3 – 1.2]
			≤1.5	0.8 [0.3 – 1.0]	0.8 [0.3 – 1.0]
			≤1.5	0.8 [0.3 – 1.0]	0.8 [0.3 – 1.0]
K Ductile cast iron	Tensile strength ≤450MPa	MR	≤1.0	1.5 [0.5 – 2.0]	1.7 [0.5 – 2.5]
			≤1.5	1.3 [0.5 – 1.8]	1.5 [0.5 – 2.0]
			≤2.0	1.2 [0.5 – 1.8]	1.3 [0.5 – 2.0]
			≤2.5	0.7 [0.3 – 1.2]	0.9 [0.3 – 1.5]
			≤3.0	0.3 [0.2 – 0.8]	0.4 [0.2 – 1.0]
		L	≤1.0	1.2 [0.3 – 2.0]	1.2 [0.3 – 2.0]
			≤1.5	1.0 [0.3 – 1.7]	1.0 [0.3 – 1.7]
			≤2.0	0.8 [0.3 – 1.5]	0.8 [0.3 – 1.5]
			≤1.0	1.3 [0.4 – 1.8]	1.5 [0.4 – 2.0]
			≤1.5	1.2 [0.4 – 1.5]	1.3 [0.4 – 1.8]
	Tensile strength ≤800MPa	M	≤2.0	1.0 [0.4 – 1.5]	1.2 [0.4 – 1.8]
			≤1.0	1.0 [0.3 – 1.7]	1.0 [0.3 – 1.7]
		L	≤1.0	1.0 [0.3 – 1.7]	1.0 [0.3 – 1.7]
			≤1.5	0.8 [0.3 – 1.5]	0.8 [0.3 – 1.5]
			≤2.0	0.7 [0.3 – 1.2]	0.7 [0.3 – 1.2]

1/1

1. To discharge chips effectively, use an air blow when machining. When the air blow is less effective at discharging chips, we recommend wet cutting.
2. When wet cutting, tool life may become shorter than dry cutting. When carrying out wet cutting for the applications recommended with dry cutting, reduce the cutting speed by 25 %.
3. When large vibration occurs, reduce the cutting conditions.
4. For interrupted cutting, reduce the cutting speed and feed rate by 20 %.

MV1000 SERIES

RECOMMENDED CUTTING CONDITIONS

VPX200/300

CUTTING SPEED (DRY CUTTING)

Material	Properties	Conditions	Recommendation 1st 2nd	ae									
				≤0.25 DC		0.25 – 0.5 DC		0.5 – 0.75 DC		DC (Slot)			
				MV1020	MV1030	MV1020	MV1030	MV1020	MV1030	MV1020	MV1030		
P	Mild steel	≤180HB	●●	L	M	280 (220-330)	230 (180-270)	270 (210-320)	220 (170-260)	220 (170-260)	180 (140-210)	220 (170-260)	180 (140-210)
	Carbon steel Alloy steel	180-280HB	●●	L	M	220 (170-260)	180 (140-210)	210 (160-240)	170 (130-200)	170 (130-200)	140 (110-160)	170 (130-200)	170 (130-200)
		280-350HB	●●	L	M	180 (140-210)	180 (140-210)	170 (130-200)	170 (130-200)	140 (110-160)	140 (110-160)	140 (110-160)	140 (110-160)
M	Stainless steel	≤200HB	●●	L	M	—	180 (140-210)	—	170 (130-200)	—	140 (110-160)	—	140 (110-160)
		>200HB	●●	L	M	—	150 (110-180)	—	140 (100-160)	—	110 (80-130)	—	110 (80-130)
K	Ductile cast iron	Tensile strength ≤450MPa	●●	M	L	200 (150-280)	150 (100-200)	190 (140-270)	140 (90-190)	170 (130-240)	125 (80-170)	170 (130-240)	100 (80-120)
		Tensile strength ≤800MPa	●●	M	L	180 (140-250)	150 (100-200)	170 (130-240)	140 (90-190)	150 (120-210)	125 (80-170)	150 (120-210)	150 (120-210)

1/1

WET CUTTING

Material	Properties	Conditions	Recommendation 1st 2nd	ae									
				≤0.25 DC		0.25 – 0.5 DC		0.5 – 0.75 DC		DC (Slot)			
				MV1020	MV1030	MV1020	MV1030	MV1020	MV1030	MV1020	MV1030		
P	Mild steel	≤180HB	●●	L	M	210 (150-290)	140 (100-190)	200 (140-270)	130 (90-180)	150 (110-180)	100 (70-120)	150 (110-180)	100 (70-120)
	Carbon steel Alloy steel	180-280HB	●●	L	M	180 (140-210)	120 (90-140)	170 (120-200)	110 (80-130)	150 (110-180)	100 (70-120)	150 (110-180)	100 (70-120)
		280-350HB	●●	L	M	140 (110-160)	120 (90-140)	130 (90-150)	110 (80-130)	120 (80-140)	100 (70-120)	120 (80-140)	120 (80-140)
K	Ductile cast iron	Tensile strength ≤450MPa	●●	M	L	180 (150-240)	130 (80-180)	170 (140-230)	120 (70-170)	150 (130-200)	105 (60-150)	150 (130-200)	105 (60-150)
		Tensile strength ≤800MPa	●●	M	L	160 (130-210)	130 (80-180)	150 (120-200)	120 (70-170)	130 (110-170)	105 (60-150)	130 (110-170)	105 (60-150)

1/1

MV1000 SERIES

RECOMMENDED CUTTING CONDITIONS

VPX200

DEPTH OF CUT / FEED PER TOOTH

DRY AND WET CUTTING

Material	Properties	ae	Conditions	DC						
				Ø 16 – Ø 18		Ø 20 – Ø 25		Ø 28 – Ø 63		
				ap	fz	ap	fz	ap	fz	
P	Mild steel	≤180HB	≤0.25DC	● ●	≤6	0.10–0.15	≤8	0.10–0.20	≤8	0.10–0.25
			0.25–0.5DC	● ●	≤5	0.08–0.12	≤8	0.10–0.15	≤8	0.10–0.20
			0.5–0.75DC	● ●	≤4	0.08–0.12	≤6	0.08–0.12	≤6	0.10–0.15
			DC (Slot)	● ●	≤2	0.06–0.10	≤4	0.06–0.10	≤4	0.08–0.12
	Carbon steel Alloy steel	180–280HB	≤0.25DC	● ●	≤6	0.10–0.15	≤8	0.10–0.20	≤8	0.10–0.25
			0.25–0.5DC	● ●	≤5	0.08–0.12	≤8	0.10–0.15	≤8	0.10–0.20
			0.5–0.75DC	● ●	≤4	0.08–0.12	≤6	0.08–0.12	≤6	0.10–0.15
			DC (Slot)	● ●	≤2	0.06–0.10	≤4	0.06–0.10	≤4	0.08–0.12
		280–350HB	≤0.25DC	● ●	≤6	0.10–0.15	≤8	0.10–0.15	≤8	0.10–0.20
			0.25–0.5DC	● ●	≤5	0.08–0.12	≤8	0.08–0.12	≤8	0.10–0.15
			0.5–0.75DC	● ●	≤4	0.08–0.12	≤6	0.06–0.10	≤6	0.08–0.12
			DC (Slot)	● ●	≤2	0.06–0.10	≤4	0.06–0.10	≤4	0.06–0.10
M	Stainless steel	—	≤0.25DC	● ●	≤6	0.10–0.15	≤8	0.10–0.20	≤8	0.10–0.20
			0.25–0.5DC	● ●	≤5	0.08–0.12	≤8	0.08–0.15	≤8	0.08–0.15
			0.5–0.75DC	● ●	≤4	0.06–0.10	≤6	0.08–0.12	≤6	0.08–0.12
			DC (Slot)	● ●	≤2	0.06–0.10	≤4	0.06–0.10	≤4	0.06–0.10
K	Ductile cast iron	Tensile strength ≤800MPa	≤0.25DC	● ●	≤6	0.10–0.15	≤8	0.10–0.20	≤8	0.10–0.20
			0.25–0.5DC	● ●	≤5	0.08–0.12	≤8	0.10–0.15	≤8	0.10–0.15
			0.5–0.75DC	● ●	≤4	0.08–0.12	≤6	0.08–0.12	≤6	0.08–0.12
			DC (Slot)	● ●	≤2	0.06–0.10	≤4	0.06–0.10	≤4	0.06–0.10

1/1

- These cutting conditions should be referenced for standard shank types (last letter in designation is S) and arbor shank types. If there is chatter, insert chipping, etc. during machining, alter conditions accordingly
- Chattering vibration is more likely under the following circumstances. Use a cut and feed per tooth that are at minimum recommended conditions or below.
 - When tool overhang is long (using a long shank, screw-in type, etc.)
 - Rigidity of machine, workpiece material or attachment of workpiece material is low
 - Corner radius during pocket milling
- A type with fewer teeth is recommended when the depth of cut in the radius direction (ae) is 0.5 DC or more.
- Wet cutting is recommended, when focusing on the surface finish. (Service life is shorter than for dry cutting.)
- When using under higher than recommended cutting conditions, or for long periods of time, the clamp screw may become fatigued and break during machining. Please use a new clamp screw periodically.

MV1000 SERIES

RECOMMENDED CUTTING CONDITIONS

VPX300

DEPTH OF CUT / FEED PER TOOTH

DRY AND WET CUTTING

Material	Properties	ae	Conditions	DC				
				Ø 25		Ø 28 - Ø 80		
				ap	fz	ap	fz	
P	Mild steel	≤180HB	≤0.25DC	●●	≤11	0.10 - 0.20	≤11	0.10 - 0.30
			0.25-0.5DC	●●	≤11	0.10 - 0.15	≤11	0.10 - 0.25
			0.5-0.75DC	●●	≤8	0.08 - 0.12	≤8	0.10 - 0.20
			DC (Slot)	●●	≤5	0.06 - 0.10	≤5	0.08 - 0.15
	Carbon steel Alloy steel	180-280HB	≤0.25DC	●●	≤11	0.10 - 0.20	≤11	0.10 - 0.30
			0.25-0.5DC	●●	≤11	0.10 - 0.15	≤11	0.10 - 0.25
			0.5-0.75DC	●●	≤8	0.08 - 0.12	≤8	0.10 - 0.20
			DC (Slot)	●●	≤5	0.06 - 0.10	≤5	0.08 - 0.15
	280-350HB	≤0.25DC	●●	≤11	0.10 - 0.15	≤11	0.10 - 0.25	
		0.25-0.5DC	●●	≤11	0.08 - 0.12	≤11	0.10 - 0.20	
		0.5-0.75DC	●●	≤8	0.06 - 0.10	≤8	0.10 - 0.15	
		DC (Slot)	●●	≤5	0.06 - 0.10	≤5	0.08 - 0.12	
M	Stainless steel	—	≤0.25DC	●●	≤11	0.10 - 0.20	≤11	0.10 - 0.20
			0.25-0.5DC	●●	≤11	0.08 - 0.15	≤11	0.08 - 0.15
			0.5-0.75DC	●●	≤8	0.08 - 0.12	≤8	0.08 - 0.12
			DC (Slot)	●●	≤5	0.06 - 0.10	≤5	0.06 - 0.10
K	Ductile cast iron	Tensile strength ≤800MPa	≤0.25DC	●●	≤11	0.10 - 0.20	≤11	0.10 - 0.25
			0.25-0.5DC	●●	≤11	0.10 - 0.15	≤11	0.10 - 0.20
			0.5-0.75DC	●●	≤8	0.08 - 0.12	≤8	0.10 - 0.15
			DC (Slot)	●●	≤5	0.06 - 0.10	≤5	0.08 - 0.12

1/1

- These cutting conditions should be referenced for standard shank types (last letter in designation is S) and arbor shank types. If there is chatter, insert chipping, etc. during machining, alter conditions accordingly.
- Chattering vibration is more likely under the following circumstances. Use a cut and feed per tooth that are at minimum recommended conditions or below.
 - When tool overhang is long (using a long shank, screw-in type, etc.)
 - Rigidity of machine, workpiece material or attachment of workpiece material is low
 - Corner radius during pocket milling
- A type with fewer teeth is recommended when the depth of cut in the radius direction (ae) is 0.5 DC or more.
- Wet cutting is recommended, when focusing on the surface finish. (Service life is shorter than for dry cutting.)
- When using under higher than recommended cutting conditions, or for long periods of time, the clamp screw may become fatigued and break during machining. Please renew the clamp screw periodically.

MV1000 SERIES

RECOMMENDED CUTTING CONDITIONS

AHX440S

DRY CUTTING

Material	Properties	Vc		fz	ap	ae	
		MV1020	MV1030				
P	Mild steel	≤180HB	300 (200 – 400)	245 (190 – 300)	0.3 (0.2 – 0.4)	≤3	≤0.8 DC
	Carbon steel	180–280HB	260 (170 – 350)	210 (150 – 270)	0.3 (0.2 – 0.4)	≤3	≤0.8 DC
	Alloy steel	280–350HB	180 (100 – 250)	135 (90 – 180)	0.3 (0.2 – 0.4)	≤3	≤0.8 DC
M	Stainless steel	≤200HB	—	185 (120 – 250)	0.2 (0.1 – 0.3)	≤3	≤0.8 DC
		>200HB	—	140 (80 – 200)	0.2 (0.1 – 0.3)	≤3	≤0.8 DC
K	Ductile cast iron	Tensile strength ≤450MPa	240 (130 – 350)	185 (120 – 250)	0.2 (0.1 – 0.3)	≤3	≤0.8 DC
		Tensile strength ≤800MPa	220 (80 – 350)	150 (100 – 200)	0.2 (0.1 – 0.3)	≤3	≤0.8 DC

1/1

1. Refer to the above table and set up cutting conditions according to cutting applications.
2. When placing emphasis on surface finish quality, wet cutting is recommended. [tool life is lowered as compared to dry cutting]
3. The recommended depth of cut differs according to insert geometry.
4. When clamp rigidity is low and tool overhang is long, we recommended to reduce the cutting speed and the feed rate by 30 %.
5. Recommended wet cutting for good surface finishing of stainless steel. [Tool life is short compared to wet cutting.]

AHX475S

DRY CUTTING

Material	Properties		Vc		fz	ap	ae	
			MV1020	MV1030				
P	Mild steel	≤180HB	R	220 (170 – 270)	140 (80 – 200)	0.6	≤1.6	≤0.5 DC
			R	220 (170 – 270)	140 (80 – 200)	0.8	≤1.6	0.5 DC < ae ≤ 0.8 DC
			M	220 (170 – 270)	140 (80 – 200)	1.0	≤1.6	0.8 DC < ae ≤ DC
	Carbon steel Alloy steel	180–280HB	R	200 (150 – 250)	120 (60 – 180)	0.6	≤1.6	≤0.5 DC
			R	200 (150 – 250)	120 (60 – 180)	0.8	≤1.6	0.5 DC < ae ≤ 0.8 DC
			M	200 (150 – 250)	120 (60 – 180)	1.0	≤1.6	0.8 DC < ae ≤ DC
	280–350HB	R	150 (100 – 200)	90 (30 – 150)	0.5	≤1.6	≤0.5 DC	
		R	150 (100 – 200)	90 (30 – 150)	0.6	≤1.6	0.5 DC < ae ≤ 0.8 DC	
		R	150 (100 – 200)	90 (30 – 150)	0.7	≤1.6	0.8 DC < ae ≤ DC	
K	Ductile cast iron	Tensile strength ≤450MPa	R	200 (150 – 250)	140 (80 – 200)	0.6	≤1.6	≤0.5 DC
			R	200 (150 – 250)	140 (80 – 200)	0.8	≤1.6	0.5 DC < ae ≤ 0.8 DC
			M	200 (150 – 250)	140 (80 – 200)	1.0	≤1.6	0.8 DC < ae ≤ DC
		Tensile strength ≤800MPa	R	180 (130 – 230)	140 (80 – 200)	0.5	≤1.6	≤0.5 DC
			R	180 (130 – 230)	140 (80 – 200)	0.6	≤1.6	0.5 DC < ae ≤ 0.8 DC
			R	180 (130 – 230)	140 (80 – 200)	0.7	≤1.6	0.8 DC < ae ≤ DC

1/1

1. When clamp rigidity is low and tool overhang is long, we recommended to reduce the cutting speed and the feed rate by 30 %.

MV1000 SERIES

RECOMMENDED CUTTING CONDITIONS

WSF406W

DRY CUTTING

Material	Properties	Conditions	ap	Vc		fz	ae
				MV1020	MV1030		
Gray cast iron	Tensile strength ≤350MPa	●	ap ≤ 0.5 mm	300 (250 – 300)	150 (100 – 200)	0.13 (0.08 – 0.20)	≤0.8DC
			ap ≤ 2.0 mm	250 (210 – 300)	150 (100 – 200)	0.15 (0.10 – 0.25)	≤0.8DC
			2.0 mm < ap ≤ 4.0 mm	220 (190 – 260)	140 (80 – 200)	0.13 (0.10 – 0.20)	≤0.8DC
			4.0 mm < ap ≤ 7.5 mm	200 (180 – 230)	110 (60 – 160)	0.10 (0.08 – 0.15)	≤0.8DC
		●	ap ≤ 0.5 mm	250 (210 – 300)	150 (100 – 200)	0.13 (0.08 – 0.20)	≤0.8DC
			ap ≤ 2.0 mm	220 (190 – 260)	150 (100 – 200)	0.15 (0.10 – 0.25)	≤0.8DC
			2.0 mm < ap ≤ 4.0 mm	200 (180 – 230)	140 (80 – 200)	0.13 (0.10 – 0.20)	≤0.8DC
			4.0 mm < ap ≤ 7.5 mm	180 (160 – 210)	110 (60 – 160)	0.10 (0.08 – 0.15)	≤0.8DC
		✘	ap ≤ 0.5 mm	220 (190 – 260)	140 (80 – 200)	0.13 (0.08 – 0.20)	≤0.8DC
			ap ≤ 2.0 mm	200 (180 – 230)	140 (80 – 200)	0.15 (0.10 – 0.25)	≤0.8DC
			2.0 mm < ap ≤ 4.0 mm	180 (160 – 210)	110 (60 – 160)	0.13 (0.10 – 0.20)	≤0.8DC
			4.0 mm < ap ≤ 7.5 mm	150 (100 – 180)	80 (40 – 120)	0.10 (0.08 – 0.15)	≤0.8DC
Ductile cast iron	Tensile strength ≤450MPa	●	ap ≤ 0.5 mm	230 (200 – 250)	110 (60 – 160)	0.13 (0.08 – 0.20)	≤0.8DC
			ap ≤ 2.0 mm	200 (170 – 230)	110 (60 – 160)	0.15 (0.10 – 0.25)	≤0.8DC
			2.0 mm < ap ≤ 4.0 mm	180 (150 – 210)	90 (50 – 130)	0.13 (0.10 – 0.20)	≤0.8DC
			4.0 mm < ap ≤ 7.5 mm	160 (130 – 190)	70 (40 – 100)	0.10 (0.08 – 0.15)	≤0.8DC
		●	ap ≤ 0.5 mm	200 (170 – 230)	110 (60 – 160)	0.13 (0.08 – 0.20)	≤0.8DC
			ap ≤ 2.0 mm	180 (150 – 210)	110 (60 – 160)	0.15 (0.10 – 0.25)	≤0.8DC
			2.0 mm < ap ≤ 4.0 mm	160 (130 – 190)	90 (50 – 130)	0.13 (0.10 – 0.20)	≤0.8DC
			4.0 mm < ap ≤ 7.5 mm	140 (110 – 170)	70 (40 – 100)	0.10 (0.08 – 0.15)	≤0.8DC
		✘	ap ≤ 0.5 mm	180 (150 – 200)	90 (50 – 130)	0.13 (0.08 – 0.20)	≤0.8DC
			ap ≤ 2.0 mm	160 (130 – 190)	90 (50 – 130)	0.15 (0.10 – 0.25)	≤0.8DC
			2.0 mm < ap ≤ 4.0 mm	140 (110 – 170)	70 (40 – 100)	0.13 (0.10 – 0.20)	≤0.8DC
			4.0 mm < ap ≤ 7.5 mm	120 (90 – 150)	60 (30 – 90)	0.10 (0.08 – 0.15)	≤0.8DC
Ductile cast iron	Tensile strength ≤800MPa	●	ap ≤ 0.5 mm	230 (200 – 250)	110 (60 – 160)	0.13 (0.08 – 0.20)	≤0.8DC
			ap ≤ 2.0 mm	200 (170 – 230)	110 (60 – 160)	0.15 (0.10 – 0.25)	≤0.8DC
			2.0 mm < ap ≤ 4.0 mm	180 (150 – 210)	90 (50 – 130)	0.13 (0.10 – 0.20)	≤0.8DC
			4.0 mm < ap ≤ 7.5 mm	160 (130 – 190)	70 (40 – 100)	0.10 (0.08 – 0.15)	≤0.8DC
		●	ap ≤ 0.5 mm	200 (170 – 230)	110 (60 – 160)	0.13 (0.08 – 0.20)	≤0.8DC
			ap ≤ 2.0 mm	180 (150 – 210)	110 (60 – 160)	0.15 (0.10 – 0.25)	≤0.8DC
			2.0 mm < ap ≤ 4.0 mm	160 (130 – 190)	90 (50 – 130)	0.13 (0.10 – 0.20)	≤0.8DC
			4.0 mm < ap ≤ 7.5 mm	140 (110 – 170)	70 (40 – 100)	0.10 (0.08 – 0.15)	≤0.8DC
		✘	ap ≤ 0.5 mm	180 (150 – 210)	90 (50 – 130)	0.13 (0.08 – 0.20)	≤0.8DC
			ap ≤ 2.0 mm	160 (130 – 190)	90 (50 – 130)	0.15 (0.10 – 0.25)	≤0.8DC
			2.0 mm < ap ≤ 4.0 mm	140 (110 – 170)	70 (40 – 100)	0.13 (0.10 – 0.20)	≤0.8DC
			4.0 mm < ap ≤ 7.5 mm	120 (90 – 150)	60 (30 – 90)	0.10 (0.08 – 0.15)	≤0.8DC







1/1

MV1000 SERIES

RECOMMENDED CUTTING CONDITIONS

ASX445







DRY AND WET CUTTING

Material	Properties	Vc								
		MV1020	MV1030	fz		fz		fz		
P	Mild steel	≤180HB	300 (200–400)	275 (200–350)	0.15 (0.1–0.2)	JL	0.2 (0.1–0.3)	JM	0.3 (0.2–0.4)	JH
	Carbon steel	180–350HB	260 (170–350)	235 (170–300)	0.15 (0.1–0.2)	JL	0.2 (0.1–0.3)	JM	0.3 (0.2–0.4)	JH
	Alloy steel	280–350HB	180 (100–250)	165 (100–230)	0.15 (0.1–0.2)	JL	0.2 (0.1–0.3)	JM	0.3 (0.2–0.4)	JH
M	Stainless steel	—	—	220 (170–270)	0.15 (0.1–0.2)	JL	0.2 (0.1–0.3)	JM	0.3 (0.2–0.4)	JH
K	Ductile cast iron	Tensile strength ≤450MPa	240 (130–350)	190 (130–250)	0.15 (0.1–0.2)	JL	0.2 (0.1–0.3)	JM	0.3 (0.2–0.4)	JH, FT
		Tensile strength >450MPa	220 (80–350)	110 (80–150)	0.15 (0.1–0.2)	JL	0.2 (0.1–0.3)	JM	0.3 (0.2–0.4)	JH, FT

1/1

ASX400

DRY AND WET CUTTING

Material	Properties	Vc								
		MV1020	MV1030	fz		fz		fz		
P	Mild steel	≤180HB	300 (200–400)	275 (200–350)	0.18 (0.08–0.28)	JL	0.20 (0.10–0.30)	JM	0.25 (0.10–0.35)	JH
	Carbon steel	180–350HB	260 (170–350)	235 (170–300)	0.15 (0.07–0.23)	JL	0.18 (0.10–0.28)	JM	0.20 (0.10–0.30)	JH
	Alloy steel	280–350HB	180 (100–250)	165 (100–230)	0.13 (0.06–0.20)	JL	0.15 (0.10–0.25)	JM	0.18 (0.10–0.28)	JH
M	Stainless steel	—	—	220 (170–270)	0.15 (0.07–0.23)	JL	0.18 (0.10–0.28)	JM	0.20 (0.10–0.30)	JH
K	Ductile cast iron	Tensile strength ≤450MPa	240 (130–350)	190 (130–250)	0.18 (0.10–0.28)	JL	0.20 (0.10–0.30)	JM	0.25 (0.10–0.35)	JH, FT
		Tensile strength >450MPa	220 (80–350)	110 (80–150)	0.18 (0.10–0.28)	JL	0.20 (0.10–0.30)	JM	0.25 (0.10–0.35)	JH, FT

1/1

AHX SERIES

FEATURING ECONOMICAL, HEPTAGONAL DOUBLE SIDED
INSERTS WITH 14 CUTTING EDGES



Interested in more...

B195

www.mhg-mediastore.net



DIA EDGE

AHX SERIES

MULTI CORNER INSERT FACE MILLING CUTTERS

AHX440S

P
M
K
H



IDEAL FOR ROUGHING AND FINISHING ON SMALL AND LOW POWER MACHINES

- Diameter range \varnothing 40 – 160 mm (3 – 16 teeth)
- Double sided insert with 14 cutting edges
- Maximum depth of cut 3 mm (APMX)
- With through coolant holes (\varnothing 40 – 125 mm)
- Insert corner radius 0.8 mm and 3.2 mm

AHX475S

P
K
H



EFFICIENT HIGH-FEED MILLING AND PROCESS RELIABILITY

- Diameter range \varnothing 50 – 160 mm (4 – 12 teeth)
- Double sided insert with 14 cutting edges
- Maximum depth of cut 1.6 mm (APMX)
- With through coolant holes (\varnothing 50 – 160 mm)
- Feed rate up to 2 mm/tooth

AHX640S

P
M
K
H



IDEAL FOR GENERAL ROUGHING ON MEDIUM AND LARGER MACHINES

- Diameter range \varnothing 63 – 200 mm (4 – 12 teeth)
- Double sided insert with 14 cutting edges
- Maximum depth of cut 6 mm (APMX)
- With through coolant holes (\varnothing 63 – 125 mm)

AHX640W

K



IDEAL FOR GENERAL ROUGHING OF CAST IRON ON MEDIUM AND LARGER MACHINES

- Diameter range \varnothing 80 – 315 mm (8 – 44 teeth)
- Double sided insert with 14 cutting edges
- Maximum depth of cut 6 mm (APMX)
- High rigidity Anti-Fly (AFI) wedge clamping system

DOUBLE SIDED INSERT WITH 14 CUTTING EDGES FOR MACHINING OF STEEL, STAINLESS STEEL AND CAST IRON



ECONOMICAL HEPTAGONAL DOUBLE SIDED INSERT

Double positive cutting edge geometry offers lower cutting resistance for improved machining efficiency.

CUTTING EDGE STABILITY

Thicker inserts ensure greater stability and enable reliable machining.

SIMPLE INDICATION OF THE CUTTING EDGE

For easy handling and to recognize used and unused corners.

GRADES FOR MACHINING A WIDE RANGE OF MATERIALS

P	PVD	M	PVD	K	PVD	CVD	S	PVD	H	PVD
P10	VP15TF	M10	VP15TF	K10	VP15TF	XC5010	S10	VP20RT	H10	
P20	VP20RT	M20	VP20RT	K20	VP20RT	MC5020	S20	MP9120	H20	VP15TF
P30		M30	MP7030	K30			S30	MP9130	H30	
P40		M40	MP7130	K40			S40		H40	
			MP7140							

MP6120

For general milling of steel

MP6130

For interrupted milling of steel

MP7030

For general milling of stainless steel

MP7130

For general milling of stainless steel

MP7140

For unstable milling of stainless steel

MC5020

For general milling of cast iron

MP9120

For general milling of HRSA and titanium alloy

MP9130

For interrupted and general milling of HRSA and Titanium alloy

XC5010

The strength of ceramics allows for stable machining even when cutting at high-speeds

AHX440S / AHX475S / AHX640S

A UNIQUE FACE MILL FOR MACHINING OF STEEL, STAINLESS STEEL AND CAST IRON



AHX440S

DESIGNED TO CONTROL ABNORMAL INSERT BREAKAGE AND BODY DAMAGE

The unique conical insert shim and Anti Fly mechanism (A.F.I) hold the insert securely. The outer edge of the insert is not in contact with the body, thereby preventing damage when sudden fracturing occurs. The thick insert negates the need for a shim.

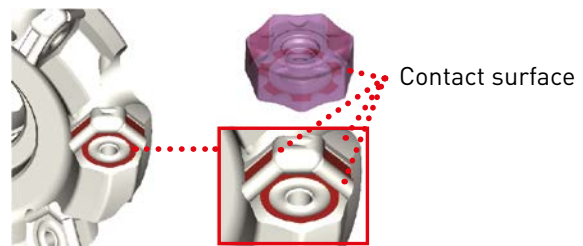

THROUGH COOLANT HOLES

Improves chip discharge and prevents chip welding.



AHX475S

AHX475S

For high feed machining

High feed is possible with AHX475S by setting an RE = 3.2 mm insert to be used in a cutter body with a corner angle of 75° [KAPR 15°]. The maximum depths of cut (APMX) will be limited to 1.6 mm.



AHX640S

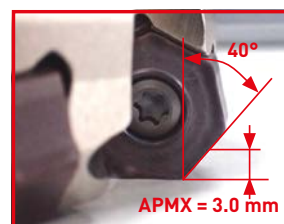

AHX440S
L Breaker

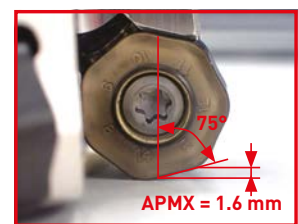

AHX475S

⚠ AHX475S is not compatible with stainless steel.

XC5010

THE STRENGTH OF CERAMICS ALLOWS FOR STABLE MACHINING EVEN WHEN CUTTING AT HIGH-SPEEDS

HIGH TEMPERATURE HARDNESS OF CEMENTED CARBIDE AND CERAMIC

Cemented carbide inserts are significantly reduced in strength when temperatures exceed 800 degrees. However, the strength of ceramic inserts is not affected at these high temperatures, therefore can be used at the high-speeds and depths of cut required to generate sufficient heat to enable machining.

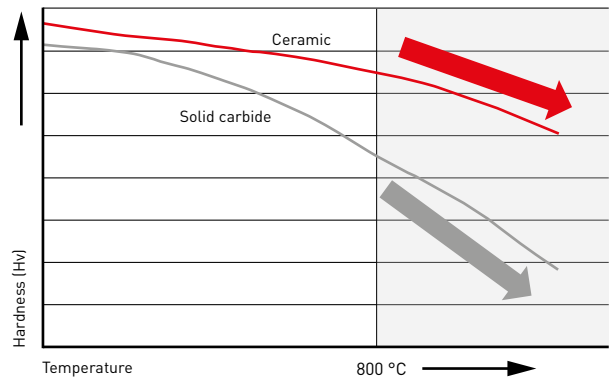

THE COMBINATION OF THE UNIQUE SHAPE AND THE COATED CERAMIC GRADE ACHIEVES STABLE MACHINING EVEN AT A CUTTING SPEEDS OF 1000 M / MIN

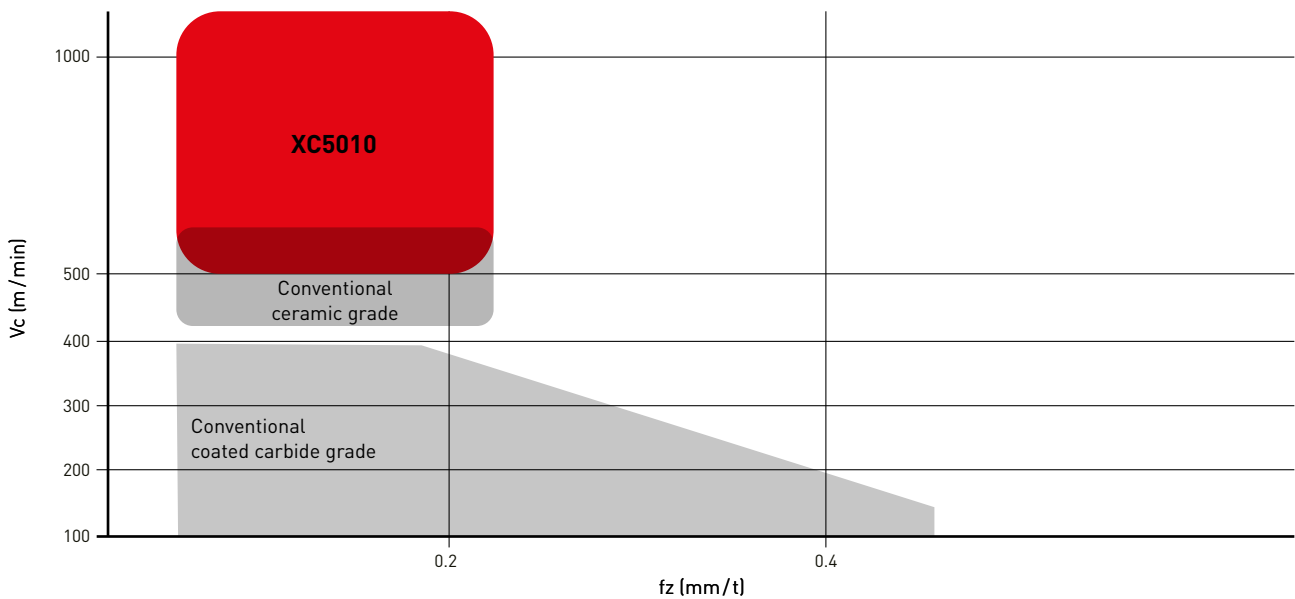

XC5010

THE STRENGTH OF CERAMICS ALLOWS FOR STABLE MACHINING EVEN WHEN CUTTING AT HIGH-SPEEDS

SURFACE-SMOOTHING Al_2O_3 COATING SUPPRESSES THE TRANSMISSION OF CUTTING HEAT

By applying an Al_2O_3 coating, which suppresses the transmission of cutting heat to the ceramic substrate, and together with a surface smoothing treatment, abnormal wear and adhesion of the workpiece material are suppressed.

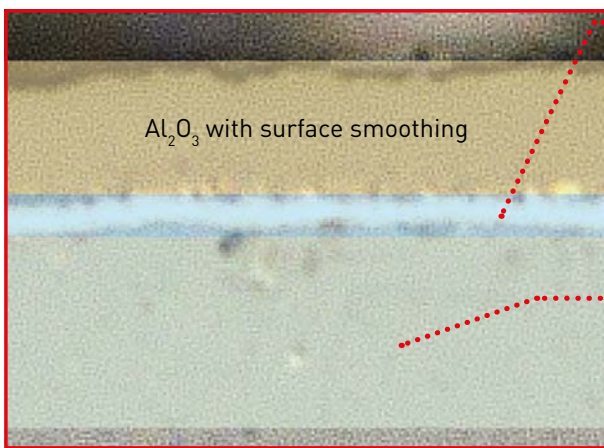

TECHNOLOGY IMPROVES ADHESION STRENGTH

Mitsubishi Materials' own adhesion technology has greatly improved the adhesion between the ceramic base material and the coating layer.

SILICON NITRIDE CERAMIC SUBSTRATE

By adopting a high toughness silicon nitride ceramic substrate as the base material, ultra-high-speed milling of ductile cast iron can be achieved even at high temperatures with minimal loss of strength.

Material	DIN GGG60
Tool	AHX640S
DC (mm)	80
Vc (m/min)	1000
fz (mm/t)	0.1
ap (mm)	2.0
ae (mm)	50
Cutting mode	Dry cutting

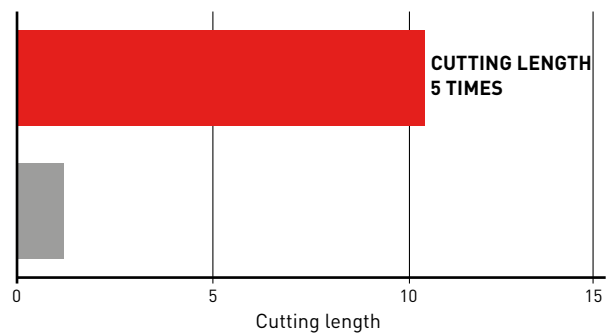

AFTER 1.2 M MACHINING



XC5010



Non-coated ceramic grade



Machining video at Vc = 1200 m/min

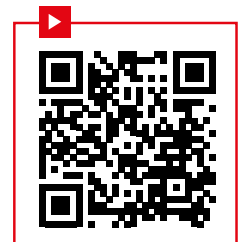

XC5010

CUTTING PERFORMANCE

COMPARISON OF WEAR WHEN MACHINING GGG70 $V_c = 1000$ M/MIN

Achieves a level of wear resistance that greatly surpasses carbide grades when high-speed roughing.

Material	DIN GGG70
Tool	AHX640S
DC (mm)	80
V_c (m/min)	1000
f_z (mm/t)	0.1
a_p (mm)	2.0
a_e (mm)	40
Cutting mode	Dry cutting Single insert

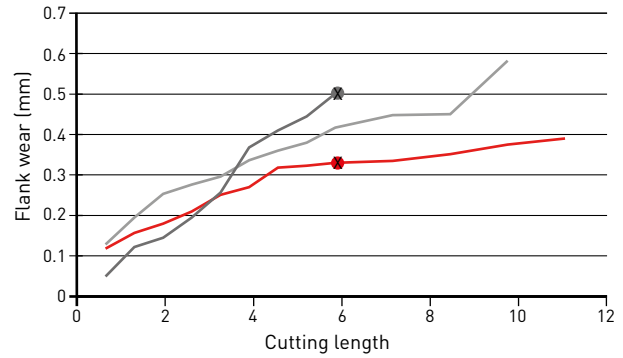

AFTER MACHINING 6 M



XC5010



Conventional A

COMPARISON OF FINISHED SURFACES WHEN MACHINING GGG70 AT $V_c = 1000$ M/MIN

A high quality machined surface is maintained even after a cutting length of 20 m.

Material	DIN GGG70
Tool	AHX640S
DC (mm)	125
V_c (m/min)	1000
f_z (mm/t)	0.1
a_p (mm)	2.0
a_e (mm)	100
Cutting mode	Dry cutting

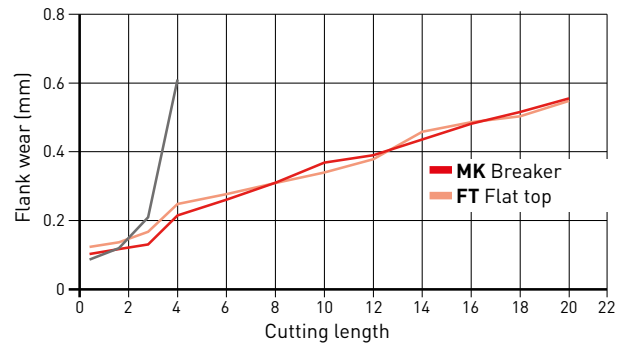

Cutting length 4 m



XC5010
MK Breaker

Cutting length 20 m

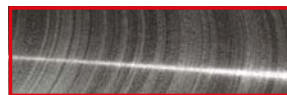

XC5010
MK Breaker



XC5010
FT Flat top



XC5010
FT Flat top



The conventional carbide grade chipped at a cutting length of 4 m.

XC5010

CHIPBREAKER SYSTEM

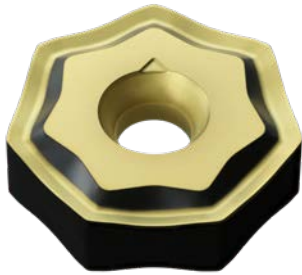

MK BREAKER – GENERAL CUTTING

When compared to flat top inserts, the cutting resistance is lower when using the MK breaker. This reduces the load on the spindle thereby making it suitable for high speed cutting.

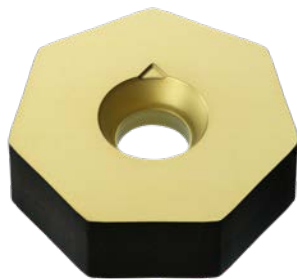

FT FLAT TOP – CUTTING EDGE STRENGTH

The high cutting edge strength of the flat top type enables stable cutting over long periods and helps to prevent sudden edge chipping.

The height setting when using MK inserts is different than when using FT type inserts.

GGG60 FINISH SURFACE COMPARISON

A high quality machined surface is maintained even when high speed cutting conditions are used.

Material	DIN GGG60
Tool	AHX640S
DC (mm)	63
fz (mm/t)	0.1
ap (mm)	1.0
ae (mm)	32
Cutting mode	Dry cutting

Vc = 1000 m/min



Vc = 250 m/min

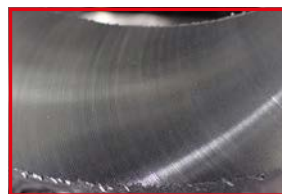

XC5010
MK Breaker



Conventional,
Coated carbide grade



AHX STEEL SERIES

SELECTION REFERENCE TABLE (CUTTING EDGE COUNT AND CUTTING CONDITIONS)

DC	Type	ZEFF	AHX440S			AHX475S			AHX640S		
			General cutting			High feed machining			General cutting		
			Stock	fr	APMX	Stock	fr	APMX	Stock	fr	APMX
40	Fine pitch	3	●	0.6-1.2	3						
	Extra fine pitch	4	●	0.8-1.6	3						
50	Fine pitch	4	●	0.8-1.6	3	●	2.4-4.0	1.6			
	Extra fine pitch	5	●	1.0-2.0	3	●	3.0-5.0	1.6			
	Super extra fine pitch	6	●	1.2-2.4	3						
63	Coarse pitch	4							●	0.8-1.6	6
	Fine pitch	5	●	1.0-2.0	3	●	3.0-5.0	1.6	●	1.0-2.0	6
	Extra fine pitch	6	●	1.2-2.4	3	●	3.6-6.0	1.6			
	Super extra fine pitch	8	●	1.6-3.2	3						
80	Coarse pitch	4							●	0.8-1.6	6
	Fine pitch	6	●	1.2-2.4	3	●	3.6-6.0	1.6	●	1.2-2.4	6
	Extra fine pitch	8	●	1.6-3.2	3	●	4.8-8.0	1.6			
	Super extra fine pitch	10	●	2.0-4.0	3						
100	Coarse pitch	5							●	1.0-2.0	6
	Fine pitch	7	●	1.4-2.8	3	●	4.2-7.0	1.6	●	1.4-2.8	6
	Extra fine pitch	9				●	5.4-9.0	1.6			
	Extra fine pitch	10	●	2.0-4.0	3						
	Super extra fine pitch	12	●	2.4-4.8	3						
125	Coarse pitch	6							●	1.2-2.4	6
	Fine pitch	8	●	1.6-3.2	3	●	4.8-8.0	1.6	●	1.6-3.2	6
	Extra fine pitch	10				●	6.0-10.0	1.6			
	Extra fine pitch	12	●	2.4-4.8	3						
	Super extra fine pitch	14	●	2.8-5.6	3						
160	Coarse pitch	7							●	1.4-2.8	6
	Fine pitch	10	●	2.0-4.0	3	●	6.0-10.0	1.6	●	2.0-4.0	6
	Extra fine pitch	12				●	7.2-12.0	1.6			
	Extra fine pitch	14	●	2.8-5.6	3						
	Super extra fine pitch	16	●	3.2-6.4	3						
200	Coarse pitch	8							●	1.6-3.2	6
	Fine pitch	12							●	2.4-4.8	6

1. fr: Feed rate per revolution (AHX475S: the feed rate per cutter (fz) will be limited by the cutting width ae. Please refer to page 91 for details.)
2. APMX: Maximum depths of cut (AHX440S: the maximum depths of cut will vary depending on the type of chipbreaker.)
3. The depths of cut and feed rate are identical to the recommended conditions for carbon steel and alloy steel.

AHX STEEL SERIES

SELECTION REFERENCE TABLE (CUTTING EDGE COUNT AND CUTTING CONDITIONS)

COMPATIBILITY WITH INSERTS FOR AHX SERIES

The RE = 3.2 mm insert for use with AHX440S can be mounted on AHX475S type cutters.
 All inserts for use with AHX640 can be mounted on AHX640S (note, however, that the height setting will differ).
 The inserts for mounting on AHX640W are the MK, HK, WK and FT breaker types for casting.

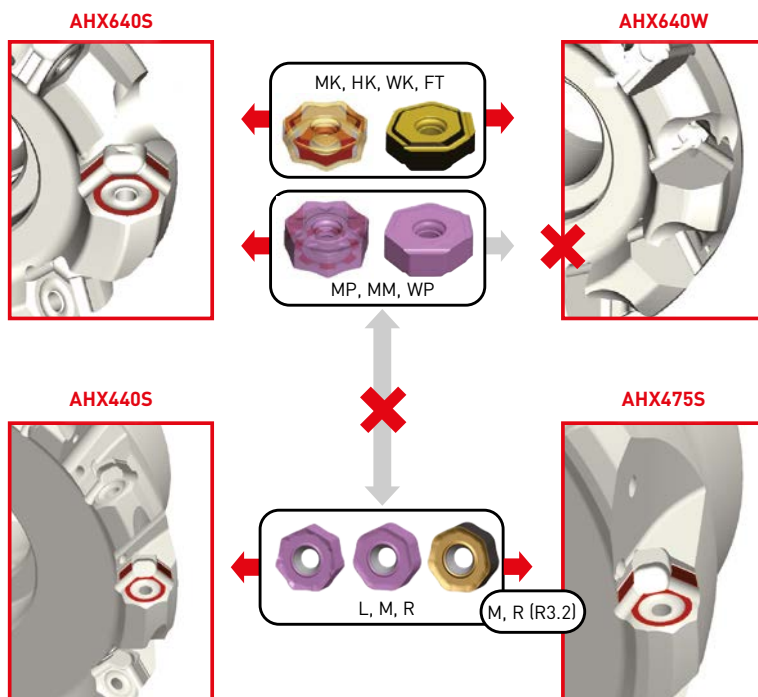

AHX STEEL SERIES

CHIPBREAKER SYSTEM



L Breaker

- Focus on cutting edge sharpness
- Low resistance type



M Breaker

- First Recommendation
- General use

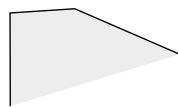

R Breaker

- Focus on fracture resistance
- Reinforced edge type

Cutting conditions:

●: Stable cutting ●: General cutting ✚: Unstable cutting

AHX440S

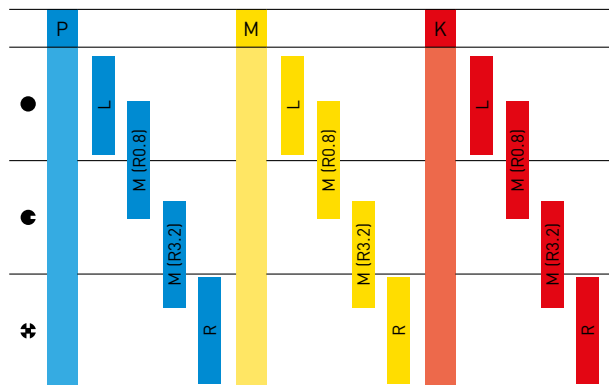

AHX640S

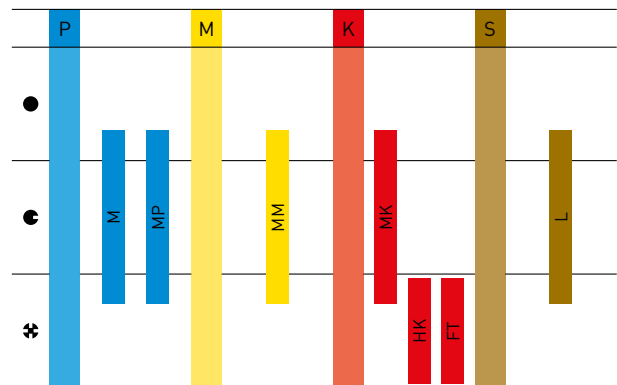

WIPER INSERT OF AHX640S

Based on the number of inserts and the cutting conditions, use of wiper inserts can improve overall surface finishes.

WP + combination with **MP**
P Right-hand 2 corners,
 left-hand 2 corners.



WK + combination with **MK**
K Right-hand 2 corners,
 left-hand 2 corners.



AHX640W

FACE MILLING CUTTER FOR HIGH EFFICIENCY MACHINING OF CAST IRON

HIGH RIGIDITY INSERTS SUITABLE FOR HIGH FEED MACHINING



Sloped cutting edge and large rake angle

INNOVATIVE CLAMP SYSTEM

New type of wedge developed to increase the permissible number of teeth. Unique geometry uses a protruding section that fits inside the insert hole and acts as an Anti-Fly Insert (AFI) mechanism.

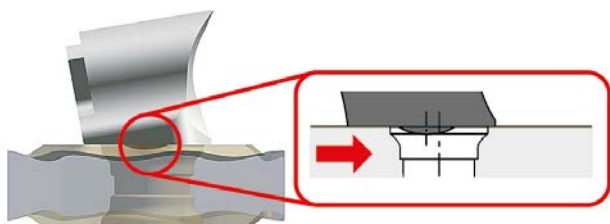

Prevents insert from flying out of the pocket.

2 VARIATIONS FOR DIFFERENT APPLICATIONS

Extra fine pitch and super extra fine pitch types allow high efficiency milling under various machining conditions. Additionally, left hand types for use on special machines are also available as standard. Inserts can be used with both right and left hand type cutters.

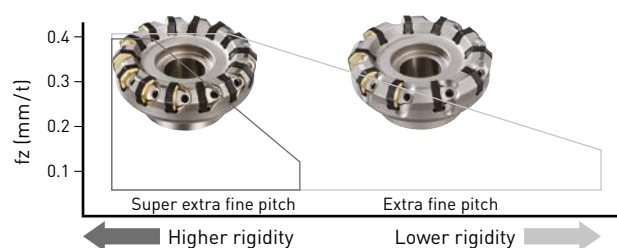

AHX640W

FACE MILLING CUTTER FOR HIGH EFFICIENCY MACHINING OF CAST IRON

INSERT APPLICATIONS

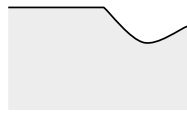
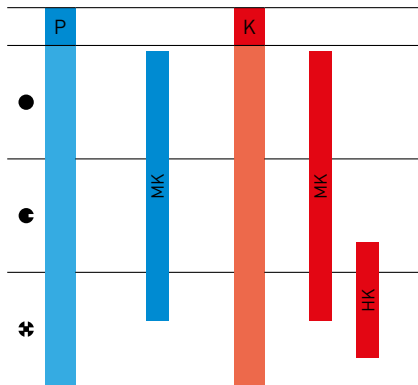

MK General purpose insert

- Accurate tolerance M-class insert.
 - Neutral, double sided 14 corners.
 - 20° rake angle for low cutting resistance.
- First recommendation for roughing and finishing.



HK Strong cutting edge insert

- Accurate tolerance M-class insert.
- Neutral, double sided 14 corners.
- High cutting edge strength to prevent fracturing of the cutting edge during unstable machining of non-uniform workpieces and high feed machining.

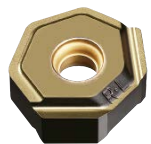

WK Wiper Insert

- Right-hand 2 corners, left-hand 2 corners.
- Based on the number of inserts and the cutting conditions, by using the wiper inserts it is possible to improve the overall surface finish.

1. The insert for AHX640W is compatible with AHX640S.
2. Please refer to page 79 for the proper use of the XC5010 insert.

MV1020 / MV1030

NEWLY DEVELOPED AL-RICH COATING

ADVANCED WEAR AND THERMAL SHOCK RESISTANT

By adopting the newly developed Al-Rich coating technology, the (Al,Ti)N with a high Al content ratio displays a very high hardness. This greatly improves oxidation and wear resistance. The extreme heat resistance of this new series achieves amazing stability not only when dry cutting, but also during wet cutting where inserts are usually prone to thermal cracking. MV1020 offers overwhelmingly superior performance in high-speed cutting, and MV1030 achieves stable performance during interrupted and stainless steel machining.

□ High hardness phase

⬡ Soft phase

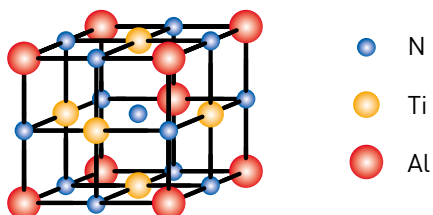
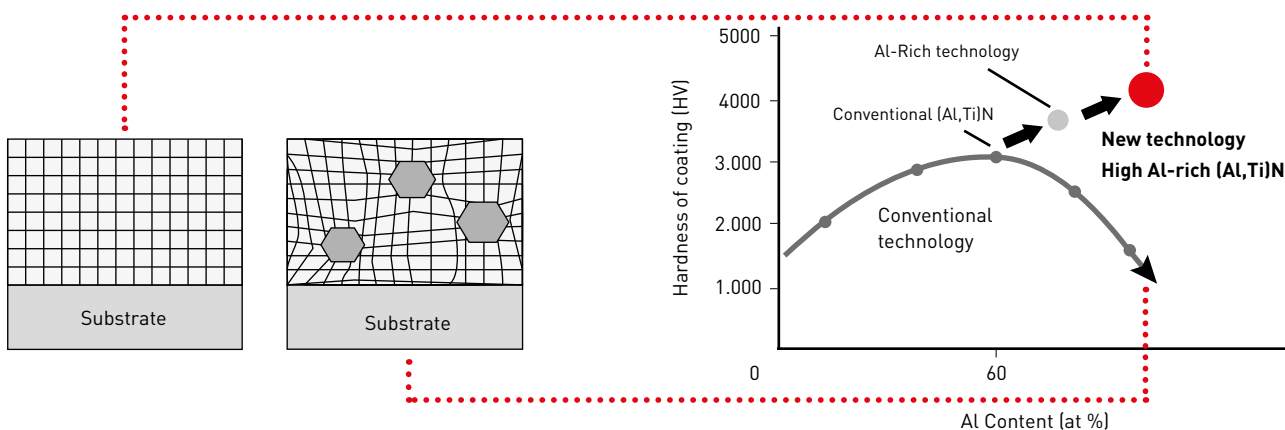

Crystal image of MV1000 series

CUTTING PERFORMANCE

COMPARISON OF WEAR RESISTANCE WHEN MACHINING DUCTILE CAST IRON

Material	DIN GGG70
Tool	AHX440
Insert	NNMU130508ZEN-M
Vc (m/min)	300
fz (mm/t)	0.1
ap (mm)	2.0
ae (mm)	52
Cutting mode	Dry cutting Single insert

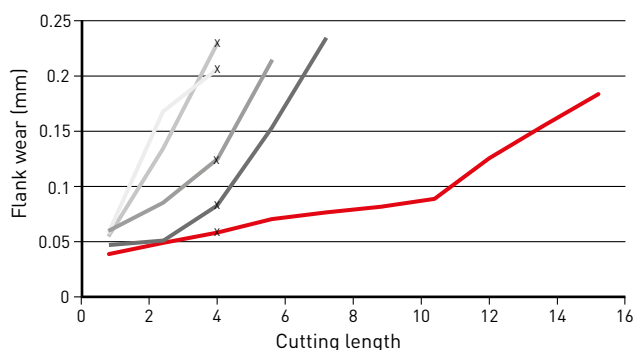

TAKEN AFTER CUTTING LENGTH OF 4.0 M

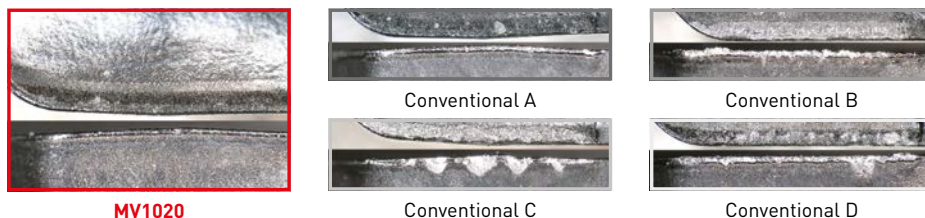

MC5020

MC5020 has excellent wear, chipping and thermal crack resistance. These features prevent the problems usually associated with machining cast iron over prolonged periods.

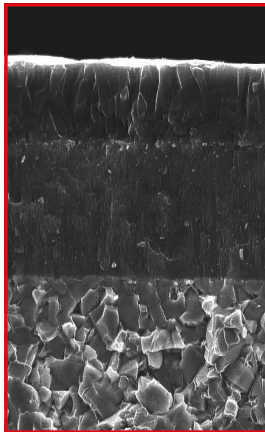

Structure of
MC5020

IMPROVED WEAR RESISTANCE

The micro-grain wear resistant Al_2O_3 and fibrous TiCN layers deliver excellent wear resistance when milling a wide range of cast irons.

IMPROVED FRACTURE RESISTANCE

Use of a specially developed cemented carbide that provides superior resistance to fracture and thermal cracking prevents the cutting edge from sudden fracturing.

REDUCED ABNORMAL DAMAGE

A black super smooth coating prevents abnormal damage such as weld chipping.

BLACK SUPER SMOOTH COATING

COMPARISON OF COATING SURFACE

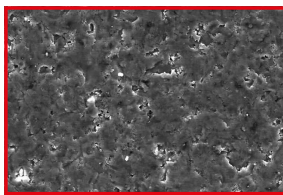

MC5020

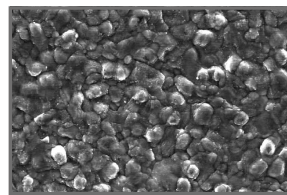

Conventional

CUTTING PERFORMANCE

WEAR RESISTANCE



MC5020

SURFACE FINISH



Surface finish condition

CUTTING PERFORMANCE

WEAR RESISTANCE

Material	DIN GG30
Tool	AHX640WR10010D
Insert	NNMU200608ZEN-MK
Vc (m/min)	300
fz (mm/t)	0.3
ap (mm)	5.0
ae (mm)	100
Cutting mode	Dry cutting Single insert

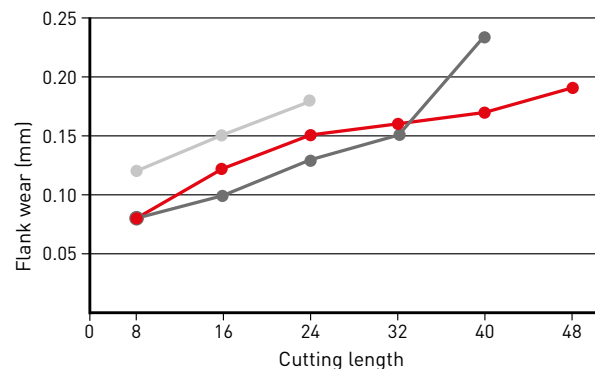

Wear comparison when machining with a single tooth.

SURFACE FINISH

Material	DIN GGG70
Tool	AHX640WR10014D
Insert	NNMU200608ZEN-MK
Wiper insert	WNEU2006ZEN7C-WK
Vc (m/min)	350
fz (mm/t)	0.1
ap (mm)	0.4
ae (mm)	80
Cutting mode	Air blow

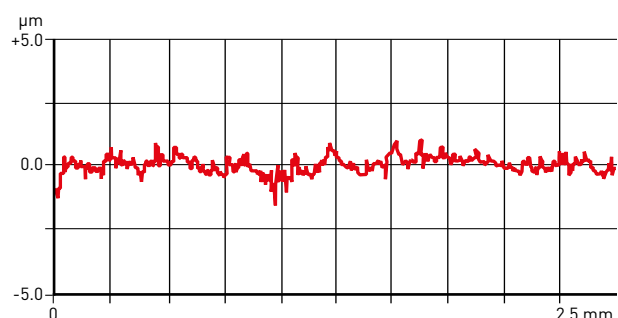

AHX440S



FACE MILL

P **M** **K** **H**



KAPR: 50°
GAMP: -10°
GAMF: -7°

1

Ø 40
Ø 50
Ø 63
Ø 80

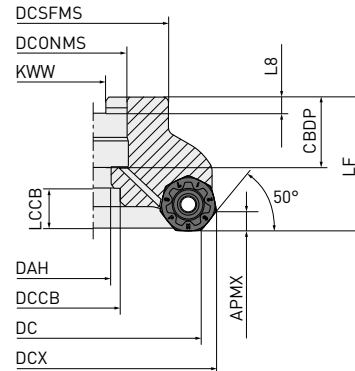

2

Ø 100
Ø 125
Ø 160

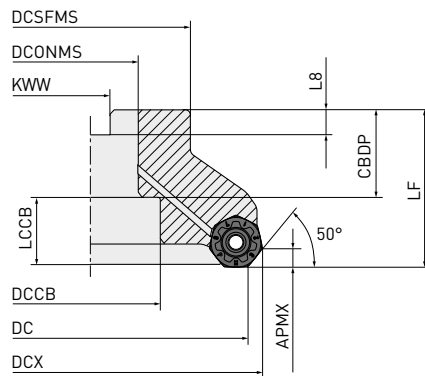

3

Ø 160

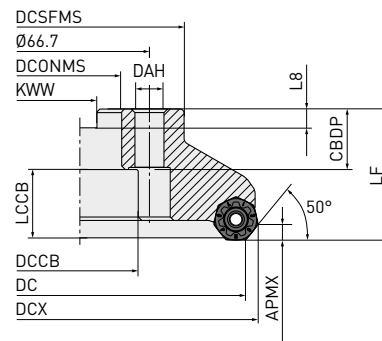

Right hand tool holder only.

Tool holder type	Set bolt order number		Geometry
AHX440S-040A ^{AR}	HSC08025H	HSC08040	<div style="display: flex; align-items: center;"> <div style="margin-right: 10px;">1</div> </div>
AHX440S-050A ^{AR}	HSC10030H	HSC10035	
AHX440S-063A ^{AR}	HSC10030H	HSC10035	
AHX440S-080A ^{AR}	HSC12035H	HSC12035 HSC12045	
AHX440S-100B ^{AR}	MBA16033H	—	<div style="display: flex; align-items: center;"> <div style="margin-right: 10px;">2</div> </div>
AHX440S-125B ^{AR}	MBA20040H	—	

AHX440S – FACE MILL

ARBOR TYPE

Order number	Stock	APMX	DC	DCONMS	LF	WT	ZEFF		Type
AHX440S-040A03AR	●	3	40	16	40	0.3	3	○	1
AHX440S-040A04AR	●	3	40	16	40	0.2	4	○	1
AHX440S-050A04AR	●	3	50	22	40	0.4	4	○	1
AHX440S-050A05AR	●	3	50	22	40	0.4	5	○	1
AHX440S-050A06AR	●	3	50	22	40	0.4	6	○	1
AHX440S-063A05AR	●	3	63	22	40	0.6	5	○	1
AHX440S-063A06AR	●	3	63	22	40	0.6	6	○	1
AHX440S-063A08AR	●	3	63	22	40	0.5	8	○	1
AHX440S-080A06AR	●	3	80	27	50	1.1	6	○	1
AHX440S-080A08AR	●	3	80	27	50	1.1	8	○	1
AHX440S-080A10AR	●	3	80	27	50	1.1	10	○	1
AHX440S-100B07AR	●	3	100	32	50	1.6	7	○	2
AHX440S-100B10AR	●	3	100	32	50	1.6	10	○	2
AHX440S-100B12AR	●	3	100	32	50	1.6	12	○	2
AHX440S-125B08AR	●	3	125	40	63	3.0	8	○	2
AHX440S-125B12AR	●	3	125	40	63	3.0	12	○	2
AHX440S-125B14AR	●	3	125	40	63	2.9	14	○	2
AHX440S-160C10NR	●	3	160	40	63	4.8	10	—	3
AHX440S-160C14NR	●	3	160	40	63	4.6	14	—	3
AHX440S-160C16NR	●	3	160	40	63	4.7	16	—	3

1/1

1. The cutter body is not supplied with the set bolt for the arbor. Please order a set bolt separately.
2. ○ = With through coolant holes



MOUNTING DIMENSIONS

Order number	CBDP	DAH	DCCB	DCONMS	DCSFMS	DCX	KWW	L8	Type
AHX440S-040A03AR	18	9	—	16	37	48.4	8.4	5.6	1
AHX440S-040A04AR	18	9	—	16	37	48.4	8.4	5.6	1
AHX440S-050A04AR	20	11	—	22	47	58.4	10.4	6.3	1
AHX440S-050A05AR	20	11	—	22	47	58.4	10.4	6.3	1
AHX440S-050A06AR	20	11	—	22	47	58.4	10.4	6.3	1
AHX440S-063A05AR	20	11	—	22	50	71.4	10.4	6.3	1
AHX440S-063A06AR	20	11	—	22	50	71.4	10.4	6.3	1
AHX440S-063A08AR	20	11	—	22	50	71.4	10.4	6.3	1
AHX440S-080A06AR	23	13	—	27	56	88.4	12.4	7	1
AHX440S-080A08AR	23	13	—	27	56	88.4	12.4	7	1
AHX440S-080A10AR	23	13	—	27	56	88.4	12.4	7	1
AHX440S-100B07AR	32	—	45	32	78	108.4	14.4	8	2
AHX440S-100B10AR	32	—	45	32	78	108.4	14.4	8	2
AHX440S-100B12AR	32	—	45	32	78	108.3	14.4	8	2
AHX440S-125B08AR	40	—	56	40	89	133.4	16.4	9	2
AHX440S-125B12AR	40	—	56	40	89	133.4	16.4	9	2
AHX440S-125B14AR	40	—	56	40	89	133.3	16.4	9	2
AHX440S-160C10NR	40	—	56	40	100	168.4	16.4	9	3
AHX440S-160C14NR	40	—	56	40	100	168.4	16.4	9	3
AHX440S-160C16NR	40	—	56	40	100	168.4	16.4	9	3

1/1

● : Inventory maintained. ★ : Inventory maintained in Japan.

AHX440S

RECOMMENDED CUTTING CONDITIONS

DRY CUTTING

Material	Properties	Grade	Vc	fz	ap	ae	
P	Mild steel	<180HB	MV1020	300 (200–400)	0.30 (0.20–0.40)	≤3	≤0.8DC
			MP6120	250 (200–300)	0.30 (0.20–0.40)	≤3	≤0.8DC
			VP15FT	250 (200–300)	0.30 (0.20–0.40)	≤3	≤0.8DC
			MV1030	245 (190–300)	0.30 (0.20–0.40)	≤3	≤0.8DC
			MP6130	240 (190–290)	0.30 (0.20–0.40)	≤3	≤0.8DC
	Carbon steel Alloy steel	180–280HB	MV1020	260 (170–350)	0.30 (0.20–0.40)	≤3	≤0.8DC
			MP6120	220 (170–270)	0.30 (0.20–0.40)	≤3	≤0.8DC
			VP15FT	220 (170–270)	0.30 (0.20–0.40)	≤3	≤0.8DC
			MV1030	210 (150–270)	0.30 (0.20–0.40)	≤3	≤0.8DC
		280–350HB	MP6130	200 (150–250)	0.30 (0.20–0.40)	≤3	≤0.8DC
			MV1020	180 (100–250)	0.30 (0.20–0.40)	≤3	≤0.8DC
			MP6120	140 (100–180)	0.30 (0.20–0.40)	≤3	≤0.8DC
			VP15FT	140 (100–180)	0.30 (0.20–0.40)	≤3	≤0.8DC
	Alloy tool steel	≤350HB	MV1030	135 (90–180)	0.30 (0.20–0.40)	≤3	≤0.8DC
			MP6130	120 (90–150)	0.30 (0.20–0.40)	≤3	≤0.8DC
MP6120			140 (100–180)	0.15 (0.20–0.20)	≤1	≤0.8DC	
Pre-hardened steel	35–45HRC	VP15FT	140 (100–180)	0.15 (0.20–0.20)	≤1	≤0.8DC	
		MP6130	120 (90–150)	0.15 (0.20–0.20)	≤1	≤0.8DC	
M	Austenitic stainless steel	≤200HB	MP7130	200 (150–250)	0.20 (0.10–0.30)	≤3	≤0.8DC
			VP15FT	200 (150–250)	0.20 (0.10–0.30)	≤3	≤0.8DC
			MV1030	185 (120–250)	0.20 (0.10–0.30)	≤3	≤0.8DC
			MP7140	180 (120–230)	0.20 (0.10–0.30)	≤3	≤0.8DC
		≥200HB	MP7130	150 (100–200)	0.20 (0.10–0.30)	≤3	≤0.8DC
			VP15FT	150 (100–200)	0.20 (0.10–0.30)	≤3	≤0.8DC
			MV1030	140 (80–200)	0.20 (0.10–0.30)	≤3	≤0.8DC
			MP7140	130 (80–180)	0.20 (0.10–0.30)	≤3	≤0.8DC
	Ferritic and martensitic stainless steel	≤200HB	MP7130	200 (150–250)	0.20 (0.10–0.30)	≤3	≤0.8DC
			VP15FT	200 (150–250)	0.20 (0.10–0.30)	≤3	≤0.8DC
			MV1030	185 (120–250)	0.20 (0.10–0.30)	≤3	≤0.8DC
		≥200HB	MP7140	180 (120–230)	0.20 (0.10–0.30)	≤3	≤0.8DC
			MP7130	150 (100–200)	0.20 (0.10–0.30)	≤3	≤0.8DC
			VP15FT	150 (100–200)	0.20 (0.10–0.30)	≤3	≤0.8DC
			MV1030	140 (80–200)	0.20 (0.10–0.30)	≤3	≤0.8DC
Two-phase stainless steel	≤280HB	MP7140	130 (80–180)	0.20 (0.10–0.30)	≤3	≤0.8DC	
		MP7130	140 (100–180)	0.15 (0.20–0.20)	≤3	≤0.8DC	
		VP15FT	140 (100–180)	0.15 (0.20–0.20)	≤3	≤0.8DC	
Hardened stainless steel	≤450HB	MP7140	120 (80–160)	0.15 (0.20–0.20)	≤3	≤0.8DC	
		MP7130	130 (100–160)	0.15 (0.20–0.20)	≤3	≤0.8DC	
		VP15FT	130 (100–160)	0.15 (0.20–0.20)	≤3	≤0.8DC	
			MP7140	110 (80–140)	0.15 (0.20–0.20)	≤3	≤0.8DC

1/2

1. Reduce the cutting speed when using coolant.

AHX440S

RECOMMENDED CUTTING CONDITIONS

DRY CUTTING

Material	Properties	Grade	Vc	fz	ap	ae	
K Grey cast iron	<350MPa	MC5020	220 (150–300)	0.30 (0.20–0.40)	≤3	≤0.8DC	
		VP15FT	180 (130–230)	0.30 (0.20–0.40)	≤3	≤0.8DC	
	Ductile cast iron	<450MPa	MV1020	240 (130–350)	0.20 (0.10–0.30)	≤3	≤0.8DC
			MC5020	220 (150–300)	0.20 (0.10–0.30)	≤3	≤0.8DC
			MV1030	185 (120–250)	0.20 (0.10–0.30)	≤3	≤0.8DC
			VP15FT	170 (120–220)	0.20 (0.10–0.30)	≤3	≤0.8DC
Ductile cast iron	<800MPa	MV1020	220 (80–350)	0.20 (0.10–0.30)	≤3	≤0.8DC	
		MC5020	170 (150–200)	0.20 (0.10–0.30)	≤3	≤0.8DC	
		MV1030	150 (100–200)	0.20 (0.10–0.30)	≤3	≤0.8DC	
H Hardened steel	40–55HRC	VP15FT	80 (60–100)	0.15 (0.10–0.20)	≤1	≤0.8DC	

2/2

1. Reduce the cutting speed when using coolant.

AHX440S

RECOMMENDED CUTTING CONDITIONS

WET CUTTING

Material	Properties	Grade	Vc	fz	ap	ae
Austenitic stainless steel	≤200HB	MP7130	125 (100–150)	0.15 (0.10–0.20)	≤3	≤0.8DC
		VP15FT	125 (100–150)	0.15 (0.10–0.20)	≤3	≤0.8DC
		MP7140	100 (80–140)	0.15 (0.10–0.20)	≤3	≤0.8DC
	≥200HB	MP7130	100 (75–125)	0.15 (0.10–0.20)	≤3	≤0.8DC
		VP15FT	100 (75–125)	0.15 (0.10–0.20)	≤3	≤0.8DC
		MP7140	80 (55–105)	0.15 (0.10–0.20)	≤3	≤0.8DC
M Ferritic and martensitic stainless steel	≤200HB	MP7130	125 (100–150)	0.15 (0.10–0.20)	≤3	≤0.8DC
		VP15FT	125 (100–150)	0.15 (0.10–0.20)	≤3	≤0.8DC
		MP7140	100 (80–140)	0.15 (0.10–0.20)	≤3	≤0.8DC
	≥200HB	MP7130	100 (75–125)	0.15 (0.10–0.20)	≤3	≤0.8DC
		VP15FT	100 (75–125)	0.15 (0.10–0.20)	≤3	≤0.8DC
		MP7140	80 (55–105)	0.15 (0.10–0.20)	≤3	≤0.8DC
Two-phase stainless steel	≤280HB	MP7130	80 (60–100)	0.10 (0.05–0.15)	≤3	≤0.8DC
		VP15FT	80 (60–100)	0.10 (0.05–0.15)	≤3	≤0.8DC
		MP7140	60 (40– 80)	0.10 (0.05–0.15)	≤3	≤0.8DC
Hardened stainless steel	≤450HB	MP7130	70 (50– 90)	0.10 (0.05–0.15)	≤3	≤0.8DC
		VP15FT	70 (50– 90)	0.10 (0.05–0.15)	≤3	≤0.8DC
		MP7140	50 (30– 70)	0.10 (0.05–0.15)	≤3	≤0.8DC

AHX440S

RECOMMENDED CUTTING CONDITIONS

CUTTING CONDITIONS FOR WIPER INSERT

Material	Properties	Grade	Vc	fz	ap	
P	Mild steel	MP6120	250 (200–300)	0.30 (0.20–0.40)	≤0.5	
		VP15FT	250 (200–300)	0.30 (0.20–0.40)	≤0.5	
	Carbon steel	MP6120	220 (170–270)	0.30 (0.20–0.40)	≤0.5	
		VP15FT	220 (170–270)	0.30 (0.20–0.40)	≤0.5	
	Alloy steel	MP6120	140 (100–180)	0.30 (0.20–0.40)	≤0.5	
		VP15FT	140 (100–180)	0.30 (0.20–0.40)	≤0.5	
	Alloy tool steel	MP6120	140 (100–180)	0.15 (0.10–0.20)	≤0.5	
		VP15FT	140 (100–180)	0.15 (0.10–0.20)	≤0.5	
Pre-hardened steel	35–45HRC	MP6120	140 (100–180)	0.15 (0.10–0.20)	≤0.5	
		VP15FT	140 (100–180)	0.15 (0.10–0.20)	≤0.5	
M	Austenitic stainless steel	VP15FT	125 (100–150)	0.15 (0.10–0.20)	≤0.5	
		VP15FT	100 (75–125)	0.15 (0.10–0.20)	≤0.5	
	Ferritic and martensitic stainless steel	VP15FT	125 (100–150)	0.15 (0.10–0.20)	≤0.5	
		VP15FT	100 (75–125)	0.15 (0.10–0.20)	≤0.5	
	Two-phase stainless steel	VP15FT	80 (60–100)	0.10 (0.05–0.15)	≤0.5	
Hardened stainless steel	VP15FT	70 (50– 90)	0.10 (0.05–0.15)	≤0.5		
K	Grey cast iron	MC5020	320 (250–400)	0.30 (0.20–0.40)	≤0.5	
		VP15FT	220 (150–300)	0.30 (0.20–0.40)	≤0.5	
	Ductile cast iron	MC5020	250(200–300)	0.20 (0.10–0.30)	≤0.5	
		VP15FT	200 (150–250)	0.20 (0.10–0.30)	≤0.5	
		MC5020	220 (200–250)	0.20 (0.10–0.30)	≤0.5	
		VP15FT	170 (150–200)	0.20 (0.10–0.30)	≤0.5	
H	Hardened steel	40–55HRC	VP15FT	80 (60–100)	0.15 (0.10–0.20)	≤0.5

1/1

1. Refer to the table above and set up cutting conditions according to cutting applications.
2. When placing emphasis on surface finish quality, wet cutting is recommended.
(Tool life is lowered when compared to dry cutting)
3. The recommended depth of cut differs according to insert geometry.
4. When clamp rigidity is low and tool overhang is long, we recommended to reduce the cutting speed and the feed rate by 30 %.
5. Wet cutting is recommended when good surface finishes are needed on stainless steel.
(Tool life is short wehn compared to dry cutting).

AHX475S



HIGH FEED MILLING CUTTER



KAPR: 15°
T: 16°
GAMP: -6°/9°
GAMF: -10°

1

- Ø 50
- Ø 63
- Ø 80
- Ø 100

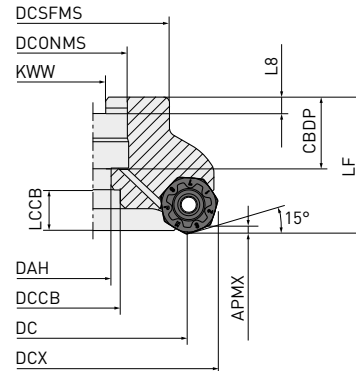

2

- Ø 125
- Ø 160

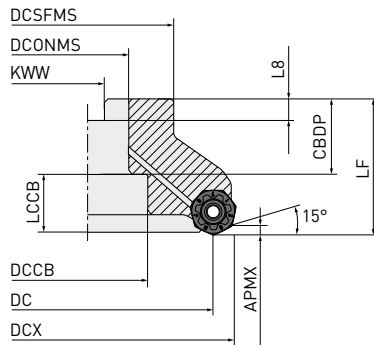

Right hand tool holder only.

Tool holder type	Set bolt order number		Geometry
AHX475S-050A [○] AR	HSC10030H	HSC10035	<div style="display: flex; align-items: center;"> <div style="margin-right: 10px;">1</div> </div>
AHX475S-063A [○] AR	HSC10030H	HSC10035	
AHX475S-080A [○] AR	HSC12035H	HSC12035	
		HSC12045	
AHX475S-100B [○] AR	HSC16040H	—	
AHX475S-125B [○] AR	MBA20040H	—	<div style="display: flex; align-items: center;"> <div style="margin-right: 10px;">2</div> <div style="border: 1px solid black; padding: 2px;">2</div> </div>
AHX475S-160B [○] AR	MBA20040H	—	

AHX475S – HIGH FEED MILLING CUTTER

ARBOR TYPE

Order number	Stock	APMX	DC	DCONMS	LF	WT	ZEFF		Type
AHX475S-050A04AR	●	1.6	50	22	50	0.6	4	○	1
AHX475S-050A05AR	●	1.6	50	22	50	0.6	5	○	1
AHX475S-063A05AR	●	1.6	63	22	50	1.0	5	○	1
AHX475S-063A06AR	●	1.6	63	22	50	0.9	6	○	1
AHX475S-080A06AR	●	1.6	80	27	50	1.6	6	○	1
AHX475S-080A08AR	●	1.6	80	27	50	1.5	8	○	1
AHX475S-100A07AR	●	1.6	100	32	63	3.2	7	○	2
AHX475S-100A09AR	●	1.6	100	32	63	3.2	9	○	2
AHX475S-125B08AR	●	1.6	125	40	63	3.8	8	○	2
AHX475S-125B10AR	●	1.6	125	40	63	3.8	10	○	2
AHX475S-160B10AR	●	1.6	160	40	63	5.4	10	○	2
AHX475S-160B12AR	●	1.6	160	40	63	5.3	12	○	2

1/1

1. The cutter body is not supplied with the set bolt for the arbor. Please order a set bolt separately.
2. ○ = With through coolant holes



MOUNTING DIMENSIONS

Order number	CBDP	DAH	DCCB	DCONMS	DCSFMS	DCX	KWW	L8	Type
AHX475S-050A04AR	20	11	17	22	47	65.6	10.4	6.3	1
AHX475S-050A05AR	20	11	17	22	47	65.6	10.4	6.3	1
AHX475S-063A05AR	20	11	17	22	60	78.6	10.4	6.3	1
AHX475S-063A06AR	20	11	17	22	60	78.6	10.4	6.3	1
AHX475S-080A06AR	23	13	20	27	76	95.6	12.4	7	1
AHX475S-080A08AR	23	13	20	27	76	95.6	12.4	7	1
AHX475S-100A07AR	26	17	26	32	96	115.6	14.4	8	2
AHX475S-100A09AR	26	17	26	32	96	115.6	14.4	8	2
AHX475S-125B08AR	40	56	—	40	100	140.6	16.4	9	2
AHX475S-125B10AR	40	56	—	40	100	140.6	16.4	9	2
AHX475S-160B10AR	40	56	—	40	100	175.6	16.4	9	2
AHX475S-160B12AR	40	56	—	40	100	175.6	16.4	9	2

1/1

AHX475S – INSERTS

P	Steel	●	★		●	●	●	Cutting conditions :								
K	Cast iron			●	●	●		●	●	●	●	●: Stable cutting ●: General cutting ★: Unstable cutting				
H	Hardened steel											●: Honing: E: Round				

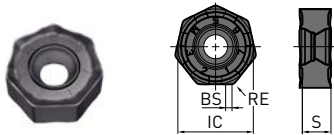
Order number	Class	Honing	MP6120	MP6130	MC5020	NEW MV1020	NEW MV1030	VP15TF	IC	S	BS	RE	APMX	Geometry
NNMU130532ZEN-M	M	E	●	●	●	●	●	●	13.4	5.09	—	3.2	1.6	
NNMU130532ZEN-R	M	E	●	●	●	●	●	13.4	5.09	—	3.2	1.6		

GRADE SELECTION

P	PVD				K	PVD		CVD		H	PVD	
P10	VP15TF	MP6120		MV1020	K10	VP15TF	MV1020			H10		
P20		MP6130			K20					H20		VP15TF
P30					K30					H30		
P40					K40					H40		

AHX475S

RECOMMENDED CUTTING CONDITIONS

DRY CUTTING

Material	Properties	Grade		Vc	fz	ap	ae
Mild steel	<180HB	MV1020	R	220 (170 – 270)	0.6	≤1.6	≤0.5DC
		MV1020	R	220 (170 – 270)	0.8	≤1.6	0.5 – 0.8DC
		MV1020	M	220 (170 – 270)	1.0	≤1.6	0.8 – 1DC
		MP6120	R	150 (100 – 200)	0.6	≤1.6	≤0.5DC
		MP6120	R	150 (100 – 200)	0.8	≤1.6	0.5 – 0.8DC
		MP6120	M	150 (100 – 200)	1.0	≤1.6	0.8 – 1DC
		MV1030	R	140 (80 – 200)	0.6	≤1.6	≤0.5DC
		MV1030	R	140 (80 – 200)	0.8	≤1.6	0.5 – 0.8DC
		MV1030	M	140 (80 – 200)	1.0	≤1.6	0.8 – 1DC
		MP6130	R	130 (80 – 180)	0.6	≤1.6	≤0.5DC
		MP6130	R	130 (80 – 180)	0.8	≤1.6	0.5 – 0.8DC
		MP6130	M	130 (80 – 180)	1	≤1.6	0.8 – 1DC
Carbon steel Alloy steel	180–280HB	MV1020	R	200 (150 – 250)	0.6	≤1.6	≤0.5DC
		MV1020	R	200 (150 – 250)	0.8	≤1.6	0.5 – 0.8DC
		MV1020	M	200 (150 – 250)	1.0	≤1.6	0.8 – 1DC
		MP6120	R	130 (80 – 180)	0.6	≤1.6	≤0.5DC
		MP6120	R	130 (80 – 180)	0.8	≤1.6	0.5 – 0.8DC
		MP6120	M	130 (80 – 180)	1.0	≤1.6	0.8 – 1DC
		MV1030	R	140 (80 – 200)	0.6	≤1.6	≤0.5DC
		MV1030	R	140 (80 – 200)	0.8	≤1.6	0.5 – 0.8DC
		MV1030	M	140 (80 – 200)	1.0	≤1.6	0.8 – 1DC
		MP6130	R	110 (60 – 160)	0.6	≤1.6	≤0.5DC
		MP6130	R	110 (60 – 160)	0.8	≤1.6	0.5 – 0.8DC
		MP6130	M	110 (60 – 160)	1	≤1.6	0.8 – 1DC
Carbon steel Alloy steel	280–350HB	MV1020	R	150 (100 – 200)	0.5	≤1.6	≤0.5DC
		MV1020	R	150 (100 – 200)	0.6	≤1.6	0.5 – 0.8DC
		MV1020	R	150 (100 – 200)	0.7	≤1.6	0.8 – 1DC
		MP6120	R	100 (50 – 150)	0.5	≤1.6	≤0.5DC
		MP6120	R	100 (50 – 150)	0.6	≤1.6	0.5 – 0.8DC
		MP6120	R	100 (50 – 150)	0.7	≤1.6	0.8 – 1DC
		MV1030	R	90 (30 – 150)	0.5	≤1.6	≤0.5DC
		MV1030	R	90 (30 – 150)	0.6	≤1.6	0.5 – 0.8DC
		MV1030	R	90 (30 – 150)	0.7	≤1.6	0.8 – 1DC
		MP6130	R	80 (30 – 130)	0.5	≤1.6	≤0.5DC
		MP6130	R	80 (30 – 130)	0.6	≤1.6	0.5 – 0.8DC
		MP6130	R	80 (30 – 130)	0.7	≤1.6	0.8 – 1DC
Alloy tool steel	<350HB	MP6120	R	100 (50 – 150)	0.5	≤1.6	≤0.5DC
		MP6120	R	100 (50 – 150)	0.6	≤1.6	0.5 – 0.8DC
		MP6120	R	100 (50 – 150)	0.7	≤1.6	0.8 – 1DC
		MP6130	R	80 (30 – 120)	0.5	≤1.6	≤0.5DC
		MP6130	R	80 (30 – 120)	0.6	≤1.6	0.5 – 0.8DC
		MP6130	R	80 (30 – 120)	0.7	≤1.6	0.8 – 1DC
Pre-hardened steel	35–45HRC	MP6120	R	100 (70 – 130)	0.5	≤1.6	≤0.5DC
		MP6120	R	100 (70 – 130)	0.6	≤1.6	0.5 – 0.8DC
		MP6120	R	100 (70 – 130)	0.7	≤1.6	0.8 – 1DC
		MP6130	R	80 (50 – 110)	0.5	≤1.6	≤0.5DC
		MP6130	R	80 (50 – 110)	0.6	≤1.6	0.5 – 0.8DC
		MP6130	R	80 (50 – 110)	0.7	≤1.6	0.8 – 1DC

AHX475S

RECOMMENDED CUTTING CONDITIONS

DRY CUTTING

Material	Properties	Grade		Vc	fz	ap	ae		
K Grey cast iron	<350MPa	MC5020	R	150 (100 – 200)	0.6	≤1.6	≤0.5DC		
		MC5020	R	150 (100 – 200)	0.8	≤1.6	0.5 – 0.8DC		
		MC5020	M	150 (100 – 200)	1.0	≤1.6	0.8 – 1DC		
		VP15FT	R	120 (80 – 160)	0.6	≤1.6	≤0.5DC		
		VP15FT	R	120 (80 – 160)	0.8	≤1.6	0.5 – 0.8DC		
		VP15FT	M	120 (80 – 160)	1.0	≤1.6	0.8 – 1DC		
K Ductile cast iron	<450MPa	MV1020	R	200 (150 – 250)	0.6	≤1.6	≤0.5DC		
		MV1020	R	200 (150 – 250)	0.8	≤1.6	0.5 – 0.8DC		
		MV1020	M	200 (150 – 250)	1.0	≤1.6	0.8 – 1DC		
		MC5020	R	150 (100 – 200)	0.6	≤1.6	≤0.5DC		
		MC5020	R	150 (100 – 200)	0.8	≤1.6	0.5 – 0.8DC		
		MC5020	M	150 (100 – 200)	1.0	≤1.6	0.8 – 1DC		
		MV1030	R	140 (80 – 200)	0.6	≤1.6	≤0.5DC		
		MV1030	R	140 (80 – 200)	0.8	≤1.6	0.5 – 0.8DC		
		MV1030	M	140 (80 – 200)	1.0	≤1.6	0.8 – 1DC		
		VP15FT	R	120 (80 – 160)	0.6	≤1.6	≤0.5DC		
		VP15FT	R	120 (80 – 160)	0.8	≤1.6	0.5 – 0.8DC		
		VP15FT	M	120 (80 – 160)	1	≤1.6	0.8 – 1DC		
K Ductile cast iron	<800MPa	MV1020	R	180 (130 – 230)	0.5	≤1.6	≤0.5DC		
		MV1020	R	180 (130 – 230)	0.6	≤1.6	0.5 – 0.8DC		
		MV1020	R	180 (130 – 230)	0.7	≤1.6	0.8 – 1DC		
		MC5020	R	150 (100 – 200)	0.5	≤1.6	≤0.5DC		
		MC5020	R	150 (100 – 200)	0.6	≤1.6	0.5 – 0.8DC		
		MC5020	R	150 (100 – 200)	0.7	≤1.6	0.8 – 1DC		
		MV1030	R	140 (80 – 200)	0.5	≤1.6	≤0.5DC		
		MV1030	R	140 (80 – 200)	0.6	≤1.6	0.5 – 0.8DC		
		MV1030	R	140 (80 – 200)	0.7	≤1.6	0.8 – 1DC		
		VP15FT	R	120 (80 – 160)	0.5	≤1.6	≤0.5DC		
		VP15FT	R	120 (80 – 160)	0.6	≤1.6	0.5 – 0.8DC		
		VP15FT	R	120 (80 – 160)	0.7	≤1.6	0.8 – 1DC		
		H Hardened steel	40–55HRC	VP15FT	R	70 (50 – 90)	0.4	≤1.6	≤0.5DC
				VP15FT	R	70 (50 – 90)	0.5	≤1.6	0.5 – 0.8DC
				VP15FT	R	70 (50 – 90)	0.6	≤1.6	0.8 – 1DC

AHX640S



FACE MILL

P **M** **K** **S** **H**



KAPR: 50°
GAMP: -5°
GAMF: -6°

1

Ø 63
Ø 80

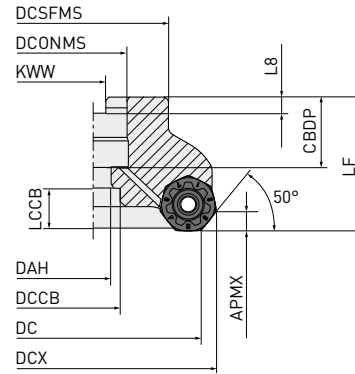

2

Ø 100
Ø 125

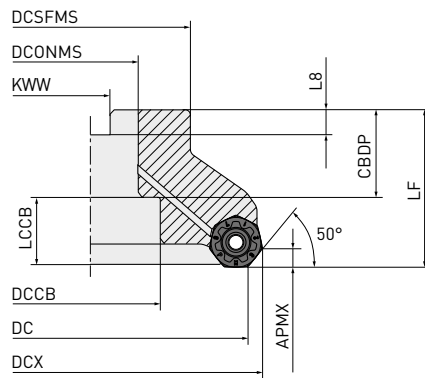

3

Ø 160

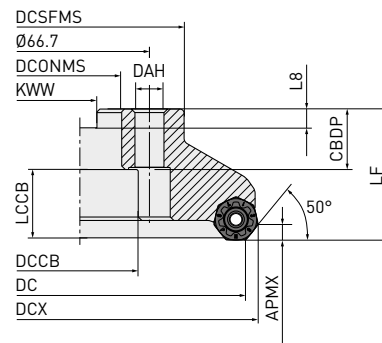

4

Ø 200

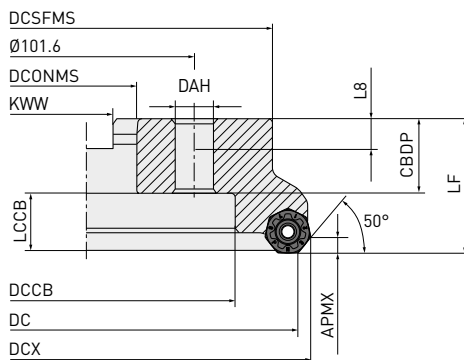

Right hand tool holder only.

Tool holder type	Set bolt	Geometry
AHX640S-063A [○] AR	HSC10030H	1
AHX640S-080A [○] AR	HSC12035H	
AHX640S-100B [○] AR	MBA16033H	
AHX640S-125B [○] AR	MBA20040H	2
AHX640S-160C [○] NR	—	—
AHX640S-200C [○] NR	—	—

AHX640S – FACE MILL

ARBOR TYPE

Order number	Stock	APMX	DC	DCONMS	LF	WT	ZEFF		Type
AHX640S-063A04AR	●	6	63	22	50	0.7	4	○	1
AHX640S-063A05AR	●	6	63	22	50	0.6	5	○	1
AHX640S-080A04AR	●	6	80	27	50	1.1	4	○	1
AHX640S-080A06AR	●	6	80	27	50	1.0	6	○	1
AHX640S-100B05AR	●	6	100	32	50	1.7	5	○	2
AHX640S-100B07AR	●	6	100	32	50	1.6	7	○	2
AHX640S-125B06AR	●	6	125	40	63	3.1	6	○	2
AHX640S-125B08AR	●	6	125	40	63	3.0	8	○	2
AHX640S-160C07NR	●	6	160	40	63	5.4	7	—	3
AHX640S-160C10NR	●	6	160	40	63	5.2	10	—	3
AHX640S-200C08NR	●	6	200	60	63	7.8	8	—	4
AHX640S-200C12NR	●	6	200	60	63	7.5	12	—	4

1/1

1. ○ = With through coolant holes



MOUNTING DIMENSIONS

Order number	CBDP	DAH	DCCB	DCONMS	DCSFMS	DCX	KWW	L8	Type
AHX640S-063A04AR	20	11	—	22	50	75.55	10.4	6.3	1
AHX640S-063A05AR	20	11	—	22	50	75.55	10.4	6.3	1
AHX640S-080A04AR	23	13	—	27	56	92.55	12.4	7	1
AHX640S-080A06AR	23	13	—	27	56	92.55	12.4	7	1
AHX640S-100B05AR	32	—	45	32	78	112.55	14.4	8	2
AHX640S-100B07AR	32	—	45	32	78	112.55	14.4	8	2
AHX640S-125B06AR	42	—	56	40	89	137.55	16.4	9	2
AHX640S-125B08AR	42	—	56	40	89	137.55	16.4	9	2
AHX640S-160C07NR	29	—	56	40	120	172.55	16.4	9	3
AHX640S-160C10NR	29	—	56	40	120	172.55	16.4	9	3
AHX640S-200C08NR	32	—	140	60	175	212.55	25.7	14.22	4
AHX640S-200C12NR	32	—	140	60	175	212.55	25.7	14.22	4

1/1

GRADE SELECTION CARBIDE

P	PVD	M	PVD	K	PVD	CVD	S	PVD	H	PVD
P10	VP15TF	M10	VP15TF	K10	VP15TF	MC5020	S10	VP20RT	H10	VP15TF
P20	VP20RT	M20	VP20RT	K20	VP20RT	MC5020	S20	MP9120	H20	VP15TF
P30	MP6130	M30	MP7030	K30	VP20RT	MC5020	S30	MP9130	H30	VP15TF
P40		M40		K40			S40		H40	

GRADE SELECTION CERAMIC







































K	CVD
K10	
K20	XC5010
K30	
K40	

● : Inventory maintained. ★ : Inventory maintained in Japan.

AHX640S

RECOMMENDED CUTTING CONDITIONS

DRY CUTTING

Material	Properties	Conditions	Grade		Vc	fz	ap	ae
P	Mild steel	<180HB	 MP6120	M	250 (200–300)	0.30 (0.20–0.40)	≤5	≤0.8DC
			 VP15FT	MP	250 (200–300)	0.30 (0.20–0.40)	≤5	≤0.8DC
			 MP6130	M	220 (170–270)	0.40 (0.30–0.50)	≤5	≤0.8DC
	Carbon steel, Alloy steel	180–280HB	 MP6120	M	220 (170–270)	0.30 (0.20–0.40)	≤5	≤0.8DC
			 VP15FT	MP	220 (170–270)	0.30 (0.20–0.40)	≤5	≤0.8DC
			 MP6130	M	190 (140–240)	0.40 (0.30–0.50)	≤5	≤0.8DC
		280–350HB	 MP6120	M	140 (100–180)	0.30 (0.20–0.40)	≤5	≤0.8DC
			 VP15FT	MP	140 (100–180)	0.30 (0.20–0.40)	≤5	≤0.8DC
			 MP6130	M	110 (70–150)	0.40 (0.30–0.50)	≤5	≤0.8DC
	Alloy tool steel	≤350HB	 MP6120	M	140 (100–180)	0.15 (0.10–0.20)	≤3	≤0.8DC
			 VP15FT	MP	140 (100–180)	0.15 (0.10–0.20)	≤3	≤0.8DC
			 MP6130	M	110 (70–150)	0.25 (0.20–0.30)	≤3	≤0.8DC
Pre-hardened steel	35–45HRC	 MP6120	M	140 (100–180)	0.15 (0.10–0.20)	≤3	≤0.8DC	
		 VP15FT	MP	140 (100–180)	0.15 (0.10–0.20)	≤5	≤0.8DC	
		 MP6130	M	110 (70–150)	0.25 (0.20–0.30)	≤3	≤0.8DC	
M	Austenitic stainless steel	≤200HB	 MP7030	MM	200 (150–250)	0.20 (0.10–0.30)	≤5	≤0.8DC
		≥200HB	 MP7030	MM	150 (100–200)	0.20 (0.10–0.30)	≤5	≤0.8DC
	Two-phase stainless steel	≤280HB	 MP7030	MM	140 (100–180)	0.15 (0.05–0.25)	≤5	≤0.8DC
	Ferritic and martensitic stainless steel	≤200HB	 MP7030	MM	200 (150–250)	0.20 (0.10–0.30)	≤5	≤0.8DC
		≥200HB	 MP7030	MM	150 (100–200)	0.20 (0.10–0.30)	≤5	≤0.8DC
	Precipitation hardening stainless steel	≤450HB	 MP7030	MM	130 (100–160)	0.15 (0.05–0.25)	≤5	≤0.8DC
K	Grey cast iron	<350MPa	 XC5010	MK, FT	800 (500–1000)	0.10 (0.10–0.30)	≤3	≤0.8DC
			 MC5020	MK, HK	220 (150–300)	0.30 (0.20–0.40)	≤5	≤0.8DC
			 VP15TF	MP	180 (130–230)	0.30 (0.20–0.40)	≤5	≤0.8DC
			 VP15TF, VP20RT	MK, HK	180 (130–230)	0.30 (0.20–0.40)	≤5	≤0.8DC
			 XC5010	MK, FT	800 (500–1000)	0.10 (0.10–0.30)	≤3	≤0.8DC
	Ductile cast iron	<450MPa	 MC5020	MK, HK	200 (150–250)	0.20 (0.10–0.30)	≤5	≤0.8DC
			 VP15TF	MP	170 (120–220)	0.20 (0.10–0.30)	≤5	≤0.8DC
			 VP15TF, VP20RT	MK, HK	170 (120–220)	0.20 (0.10–0.30)	≤5	≤0.8DC
			 XC5010	MK, FT	800 (500–1000)	0.10 (0.10–0.30)	≤3	≤0.8DC
			 MC5020	MK, HK	170 (150–200)	0.20 (0.10–0.30)	≤5	≤0.8DC
	<800MPa	 VP15TF	MP	140 (100–180)	0.20 (0.10–0.30)	≤5	≤0.8DC	
		 VP15TF, VP20RT	MK, HK	140 (100–180)	0.20 (0.10–0.30)	≤5	≤0.8DC	
		 XC5010	MK, FT	800 (500–1000)	0.10 (0.10–0.30)	≤3	≤0.8DC	
		 MC5020	MK, HK	170 (150–200)	0.20 (0.10–0.30)	≤5	≤0.8DC	
		 VP15TF	MP	140 (100–180)	0.20 (0.10–0.30)	≤5	≤0.8DC	
H	Hardened steel	40–55HRC	 VP15TF	MP	80 (60–100)	0.15 (0.10–0.20)	≤3	≤0.8DC

1/1

1. Wet cutting is recommended for good surface finishing of stainless steel. [Tool life is short compared to dry cutting.]
2. Wet cutting with internal coolant is recommended for titanium and heat resistant alloys.
3. If the clamping rigidity of the work material is low and the tool overhang is long, adjust the cutting speed and feed in the table above.

AHX640S

RECOMMENDED CUTTING CONDITIONS



WET CUTTING

Material	Properties	Grade		Vc	fz	ap	ae	
M	Austenitic stainless steel	≤200HB	MP7030	MM	125 (100–150)	0.15 (0.10–0.20)	≤5	≤0.8DC
		≥200HB	MP7030	MM	100 (75–125)	0.15 (0.10–0.20)	≤5	≤0.8DC
	Two-phase stainless steel	≤280HB	MP7030	MM	80 (60–100)	0.10 (0.05–0.15)	≤5	≤0.8DC
		≤200HB	MP7030	MM	125 (100–150)	0.15 (0.10–0.20)	≤5	≤0.8DC
	≥200HB	MP7030	MM	100 (75–125)	0.15 (0.10–0.20)	≤5	≤0.8DC	
Precipitation hardening stainless steel	≤450HB	MP7030	MM	70 (50– 90)	0.10 (0.05–0.15)	≤5	≤0.8DC	
S	Titanium alloy	—	MP7030	MM	40 (20– 50)	0.15 (0.10–0.20)	≤3	≤0.6DC
		—	MP9120	L	60 (50– 70)	0.10 (0.05–0.15)	≤3	≤0.6DC
		—	MP9130	L	40 (20– 50)	0.15 (0.10–0.20)	≤3	≤0.6DC
	Heat resistant alloy	—	MP7030	MM	40 (20– 50)	0.15 (0.10–0.20)	≤3	≤0.6DC
		—	MP9120	L	60 (50– 70)	0.10 (0.05–0.15)	≤3	≤0.6DC
—	—	MP9130	L	40 (20– 50)	0.15 (0.10–0.20)	≤3	≤0.6DC	

1/1

1. Wet cutting is recommended for good surface finishing of stainless steel. (Tool life is short compared to dry cutting.)
2. Wet cutting with internal coolant is recommended for titanium and heat resistant alloys.
3. When clamp rigidity is low and tool overhang is long, it is recommended to reduce the cutting speed and the feed rate by 30 %.

CUTTING CONDITIONS FOR WIPER INSERT

Material	Properties	Main insert		Wiper insert		Vc	fz	ap	ae	
P	Mild steel	VP15FT	MP	VP15FT	WP	250 (200–300)	0.30 (0.20–0.40)	≤0.5	≤0.8DC	
		MP6120	M	MP6120	M	250 (200–300)	0.30 (0.20–0.40)	≤0.5	≤0.8DC	
	Carbon steel, Alloy steel	180–280HB	VP15FT	MP	VP15FT	WP	220 (170–270)	0.30 (0.20–0.40)	≤0.5	≤0.8DC
		280–350HB	MP6120	M	MP6120	M	220 (170–270)	0.30 (0.20–0.40)	≤0.5	≤0.8DC
K	Grey cast iron	≤350MPa	MC5020	MK, HK	MC5020	WK	320 (250–400)	0.30 (0.20–0.40)	≤0.5	≤0.8DC
		—	VP15FT	MP	VP15FT	WP	220 (150–300)	0.30 (0.20–0.40)	≤0.5	≤0.8DC
	Ductile cast iron	≤450MPa	MC5020	MK, HK	MC5020	WK	250 (200–300)	0.20 (0.10–0.30)	≤0.5	≤0.8DC
		—	VP15FT	MP	VP15FT	WP	200 (150–250)	0.20 (0.10–0.30)	≤0.5	≤0.8DC
		≤800MPa	MC5020	MK, HK	MC5020	WK	220 (200–250)	0.20 (0.10–0.30)	≤0.5	≤0.8DC
		—	VP15FT	MP	VP15FT	WP	170 (150–200)	0.20 (0.10–0.30)	≤0.5	≤0.8DC
S	Heat resistant alloy	—	VP15FT	MP	VP15FT	WP	40 (20– 50)	0.15 (0.10–0.20)	≤0.5	≤0.8DC
H	Hardened steel	40–55HRC	VP15FT	MP	VP15FT	WP	80 (60–100)	0.15 (0.10–0.20)	≤0.5	≤0.8DC

1/1

1. When clamp rigidity is low and tool overhang is long, it is recommended to reduce the cutting speed and the feed rate by 30 %.
2. Please use WP geometry insert in combination with MP geometry inserts, and use WK geometry insert in combination with MK or HK geometry inserts

AHX640W



FACE MILLING HIGH FEED MACHINING OF CAST IRON

K



KAPR: 50°
GAMP: -5°
GAMF: -6°

1

Ø 80

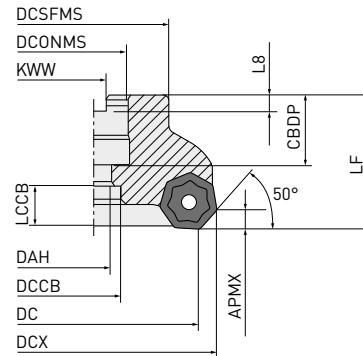

2

Ø 100
Ø 125

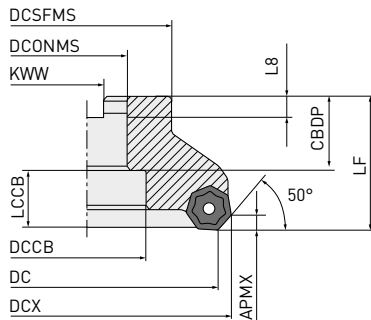

3

Ø 160

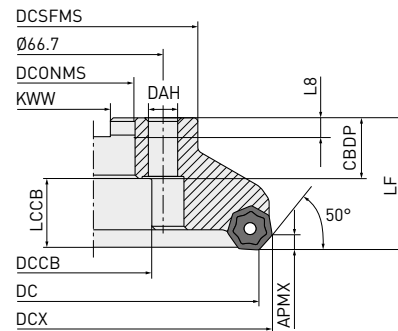

4

Ø 200
Ø 250

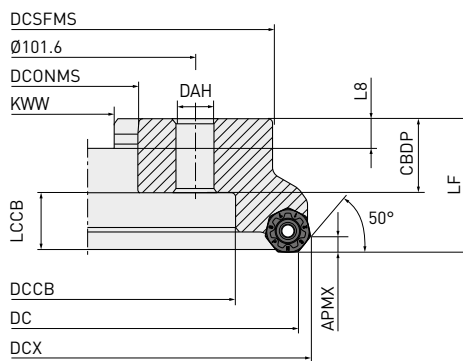

5

Ø 315

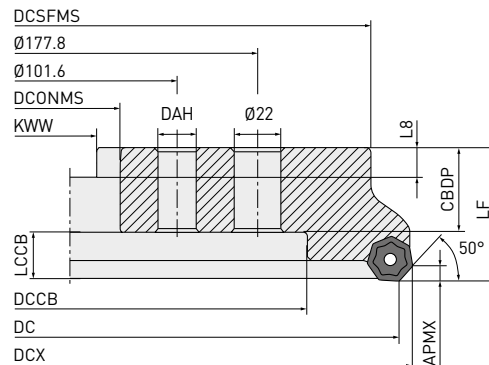

Right hand tool holder only.

AHX640W – FACE MILLING HIGH FEED MACHINING OF CAST IRON

ARBOR TYPE

Order number	Stock		APMX	DC	DCONMS	LF	WT	ZEFF	Type
	R	L							
AHX640W-080A08R/L	●	●	6	80	27	50	1.5	8	1
AHX640W-080A10R/L	●	●	6	80	27	50	1.5	10	1
AHX640W-100B10R/L	●	●	6	100	32	50	2.1	10	2
AHX640W-100B14R/L	●	●	6	100	32	50	2.1	14	2
AHX640W-125B12R/L	●	●	6	125	40	63	3.1	12	2
AHX640W-125B18R/L	●	●	6	125	40	63	3.1	18	2
AHX640W-160C16R/L	●	●	6	160	40	63	5.6	16	3
AHX640W-160C22R/L	●	●	6	160	40	63	5.6	22	3
AHX640W-200C20R/L	●	●	6	200	60	63	8.0	20	4
AHX640W-200C28R/L	●	●	6	200	60	63	8.0	28	4
AHX640W-250C24R/L	●	●	6	250	60	63	12.6	24	4
AHX640W-250C36R/L	●	●	6	250	60	63	12.6	36	4
AHX640W-315C28R/L	●	●	6	315	60	80	31.5	28	5
AHX640W-315C44R/L	●	●	6	315	60	80	31.5	44	5

1/1

108 

MOUNTING DIMENSIONS

Order number	CBDP	DAH	DCCB	DCONMS	DCSFMS	DCX	KWW	L8	Type
AHX640W-080A08R/L	23	13	—	27	56	92.6	12.4	7	1
AHX640W-080A10R/L	23	13	—	27	56	92.6	12.4	7	1
AHX640W-100B10R/L	32	—	45	32	70	112.6	14.4	8	2
AHX640W-100B14R/L	32	—	45	32	70	112.6	14.4	8	2
AHX640W-125B12R/L	32	—	56	40	80	137.6	16.4	9	2
AHX640W-125B18R/L	32	—	56	40	80	137.6	16.4	9	2
AHX640W-160C16R/L	29	—	56	40	100	172.6	16.4	9	3
AHX640W-160C22R/L	29	—	56	40	100	172.6	16.4	9	3
AHX640W-200C20R/L	32	—	135	60	155	212.6	25.7	14	4
AHX640W-200C28R/L	32	—	135	60	155	212.6	25.7	14	4
AHX640W-250C24R/L	32	—	180	60	200	262.6	25.7	14	4
AHX640W-250C36R/L	32	—	180	60	200	262.6	25.7	14	4
AHX640W-315C28R/L	57	—	225	60	285	327.6	25.7	14	5
AHX640W-315C44R/L	57	—	225	60	285	327.6	25.7	14	5

1/1

AHX640W – INSERTS

K Cast iron

Cutting conditions :

●: Stable cutting ●: General cutting ✖: Unstable cutting

Honing:

E: Round

Order number

Class

Honing

NEW

XC5010

MC5020

VP15TF

VP20RT

IC

S

BS

RE

APMX

Geometry

MK

NNMU200608ZEN-MK	M	E	●	●	●	●	20	6.1	1.0	0.8	6
------------------	---	---	---	---	---	---	----	-----	-----	-----	---

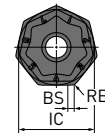

HK

NNMU200608ZEN-HK	M	E		●	●	●	20	6.1	1.0	0.8	6
------------------	---	---	--	---	---	---	----	-----	-----	-----	---

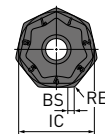

FT

NEW NNMQ200708ZEN-FT	M	E	●		●		20	6.55	1.0	0.8	6
-----------------------------	---	---	---	--	---	--	----	------	-----	-----	---

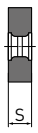
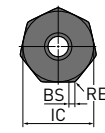

WK

WNEU2006ZEN7C-WK	E	E		●			20	6.55	7.4	0.8	0.5
------------------	---	---	--	---	--	--	----	------	-----	-----	-----

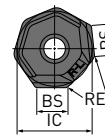

1. The inserts can be used with both right and left hand cutters.











GRADE SELECTION

K	PVD	CVD
K10	VP15TF	XC5010
K20	VP20RT	MC5020
K30		
K40		

AHX640W

RECOMMENDED CUTTING CONDITIONS





GENERAL CUTTING

Material	Properties	Conditions	Grade		Vc	fz	ap	ae
Gray cast iron	<350MPa		XC5010	MK, FT	800 (500–1000)	0.1 (0.1–0.3)	≤3	≤0.8DC
			MC5020	MK, HK	220 (150– 300)	0.3 (0.2–0.4)	≤5	≤0.8DC
			VP15TF/VP20RT	MK, HK	180 (130– 230)	0.3 (0.2–0.4)	≤5	≤0.8DC
Ductile cast iron	<450MPa		XC5010	MK, FT	800 (500–1000)	0.1 (0.1–0.3)	≤3	≤0.8DC
			MC5020	MK, HK	200 (150– 250)	0.2 (0.1–0.3)	≤5	≤0.8DC
			VP15TF/VP20RT	MK, HK	170 (120– 220)	0.2 (0.1–0.3)	≤5	≤0.8DC
	<800MPa		XC5010	MK, FT	800 (500–1000)	0.1 (0.1–0.3)	≤3	≤0.8DC
			MC5020	MK, HK	170 (150– 200)	0.2 (0.1–0.3)	≤5	≤0.8DC
			VP15TF/VP20RT	MK, HK	140 (100– 180)	0.2 (0.1–0.3)	≤5	≤0.8DC

1/1

1. With reference to the above examples, adjust the cutting conditions according to the machining set up.
2. Tool life when wet cutting is short compared to dry cutting.

FINISHING (USE OF WIPER INSERTS)

Material	Properties	Conditions	Grade		Vc	fz	ap
Gray cast iron	<350MPa		MC5020	MK, HK	320 (250–400)	0.2 (0.1–0.3)	<0.5
			MC5020	MK, HK	270 (200–350)	0.2 (0.1–0.3)	0.5–3
Ductile cast iron	<450MPa		MC5020	MK, HK	270 (200–350)	0.2 (0.1–0.3)	<0.5
			MC5020	MK, HK	220 (200–250)	0.2 (0.1–0.3)	0.5–3

1/1

1. Please use 2 – 3 wiper inserts when the feed is greater than 6 mm/rev.

MX3030

NEW CERMET GRADE FOR A WIDER RANGE OF APPLICATIONS



Interested in more...

B280

www.mhg-mediastore.net



DIA EDGE

MX3030

NEW CERMET GRADE FOR A WIDER RANGE OF APPLICATIONS

Enables excellent surface finishes even at high efficiency machining conditions.

IMPROVED MACHINING EFFICIENCY BY MAINTAINING EXCELLENT SURFACE FINISHES EVEN AT LARGE DEPTHS OF CUT

Cermet has a low affinity with iron, excellent thermal stability and oxidation resistance, and is therefore a suitable grade for finishing. However, it does not have the same bonding strength as cemented carbide thereby creating the challenge to compensate for fracture resistance.

MX3030 solves the challenge with higher thermal conductivity than conventional products and has excellent thermal cracking resistance. Therefore, it is possible to suppress wear and maintain high quality surface finishes. Also, since MX3030 has excellent toughness, improved machining efficiency even at large depths of cut can be realised.

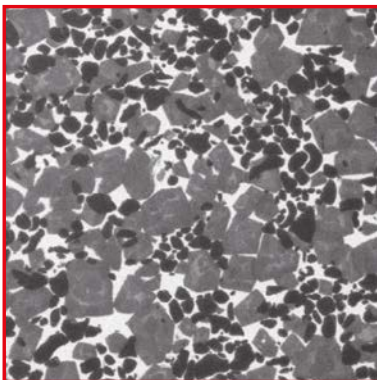

MX3030

A special alloy is used for the binder material



Fracture resistance properties increased

High hardness Ti compound particles are used in the substrate



High wear resistance properties

MILD STEEL DIN ST37-2 SURFACE FINISH COMPARISON

Material	DIN ST37-2
DC (mm)	125
Vc (m/min)	200
fz (mm/t)	0.1
ap (mm)	2.0
ae (mm)	100
Cutting mode	Dry cutting, 8 Inserts, Centre cut, After 8 m cutting work



MX3030



Conventional

MX3030

INSERTS

P	Steel	◆	◆	Please note that the cutting conditions differ depending on multiple factors, for more details refer to the recommended cutting conditions.
M	Stainless steel	◆	◆	
K	Cast iron	◆	◆	

Edge preparation: E: Round S: Chamfer + Round T: Chamfer

Order number	Hand	Class	Edge preparation	NEW		IC	S	BS	RE	Geometry
				MX3030	NX4545					
SNGU140812ANER-L	R	G	E	●	●	14.0	8.4	1.5	1.2	WSX445
SNGU140812ANER-M	R	G	E	●	●					
SNMU140812ANER-M	R	M	E	●	●					
SNGU140812ANEL-L	L	G	E	★	●					
SNGU140812ANEL-M	L	G	E	★	●					
SNMU140812ANEL-M	L	M	E	★	●					
NEW SEET13T3AGEN-JL	—	E	E	●	●	13.4	3.97	1.9	1.5	ASX445
NEW SEMT13T3AGSN-JM	—	M	S	●	●					
NEW SOET12T308PEER-JL	R	E	E	●	●	12.7	3.97	1.4	0.8	ASX400
NEW SOMT12T308PEER-JM	R	M	E	●	●					
NEW OEMX12T3ETR1	R	M	T	★	●	12.7	3.97	1.0	—	OCTACUT
NEW OEMX1705ETR1	R	M	T	★	●					
NEW RPMW10T3M0E	—	M	E	★	●	10.0	3.97	—	—	BRP
NEW RPMW1204M0E	—	M	E	★	●					
NEW SPMW090304	—	M	T	★	●	9.525	3.18	—	0.4	CESP, SFSP, CGSP
NEW SPMW090308	—	M	T	★	●					
NEW SPMW120304	—	M	T	★	●					
NEW SPMW120308	—	M	T	●	●					

1/2



(10 inserts in one case)



MX3030 – INSERTS

P	Steel	◆	◆	Please note that the cutting conditions differ depending on multiple factors, for more details refer to the recommended cutting conditions.
M	Stainless steel	◆	◆	
K	Cast iron	◆	◆	

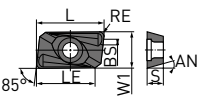
Edge preparation: E: Round S: Chamfer + Round T: Chamfer

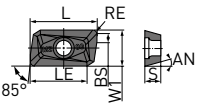
	Order number	Hand	Class	Edge preparation	MX3030		L	LE	W1	S	BS	RE	Geometry
					NEW	NX4545							
NEW	APMT1135PDER-H1	R	M	E	★	●	11.25	9	6.35	3.5	1.5	0.4	 
NEW	APMT1135PDER-H2	R	M	E	★	●	11.25	9	6.35	3.5	1.2	0.8	
NEW	APMT1135PDER-M2	R	M	E	★	●	11.18	9	6.35	3.5	1.2	0.8	
NEW	APMT1604PDER-H2	R	M	E	★	●	17.11	14	9.525	4.76	1.4	0.8	 
NEW	APMT1604PDER-M2	R	M	E	★	●	17.10	14	9.525	4.76	1.4	0.8	

2/2

(10 inserts in one case)



CUTTING PERFORMANCE

SURFACE FINISH COMPARISON WHEN MACHINING DIN 42CrMo4 ALLOY STEEL

The MX3030 grades produced an excellent finished surface with uniform machining marks with only a slight cloudiness.

Material	DIN 42CrMo4
Tool	ASX400-JL
Vc (m/min)	250
fz (mm/t)	0.05
ap (mm)	0.5
ae (mm)	100
Cutting mode	Dry cutting

Ra 0.5105 μm Rz 3.1582 μm

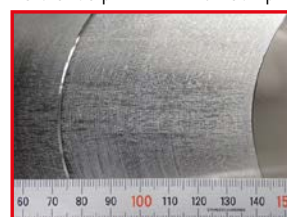

MX3030



Ra 0.5320 μm Rz 3.8950 μm



Conventional

MX3030

























RECOMMENDED CUTTING CONDITIONS

Material	Properties	Cutter type	Inserts	Vc	ft	
						
Mild steel	≤180 HB	WSX445	L, M	180 (130 – 230)	0.15	
		ASX445	JL	180 (130 – 250)	0.15	
		ASX445	JM	180 (130 – 250)	0.2	
		ASX400	JL	180 (130 – 250)	0.15	
		ASX400	JM	180 (130 – 250)	0.18	
		OCTACUT	—	180 (100 – 250)	0.2	
		BAP	H	160 (120 – 200)	0.1	
		BRP	—	180 (130 – 250)	0.30*	
Carbon steel Alloy steel	180 – 280 HB	WSX445	L, M	150 (120 – 180)	0.15	
		ASX445	JL	150 (120 – 180)	0.15	
		ASX445	JM	150 (120 – 180)	0.2	
		ASX400	JL	150 (120 – 180)	0.13	
		ASX400	JM	150 (120 – 180)	0.15	
		OCTACUT	—	120 (80 – 160)	0.2	
		BAP	H	120 (100 – 160)	0.08	
		BRP	—	150 (120 – 180)	0.30*	
	CESP, CFSP, CGSP	—	130 (100 – 160)	0.2	0.4	
	280 – 350 HB	WSX445	L, M	150 (120 – 180)	0.15	
		ASX445	JL	100 (80 – 160)	0.15	
		ASX445	JM	100 (80 – 160)	0.2	
		ASX400	JL	100 (80 – 160)	0.1	
		ASX400	JM	100 (80 – 160)	0.13	
		OCTACUT	—	100 (80 – 160)	0.2	
		BAP	—	100 (80 – 160)	0.08	
BRP		—	100 (80 – 160)	0.30*		
Stainless steel	≤270 HB	WSX445	L, M	130 (100 – 180)	0.15	
		ASX445	JL	150 (120 – 180)	0.15	
		ASX445	JM	150 (120 – 180)	0.2	
		ASX400	JL	150 (120 – 180)	0.15	
		ASX400	JM	150 (120 – 180)	0.18	
		OCTACUT	—	150 (100 – 200)	0.15	
		BAP	M	120 (80 – 140)	0.1	
		BRP4	—	150 (120 – 180)	0.30*	
Cast iron Ductile cast iron	≤500 MPa	WSX445	L, M	150 (120 – 180)	0.15	
		ASX445	JL	130 (100 – 160)	0.15	
		ASX445	JM	130 (100 – 160)	0.2	
		ASX400	JL	150 (120 – 180)	0.15	
		ASX400	JM	150 (120 – 180)	0.18	
		BAP	H	100 (80 – 120)	0.1	
		BRP4	—	150 (120 – 180)	0.30*	

1/1

* BRP is the feed amount at a depth of cut of 3 mm.

SYMBOLS

 Recommended cutting conditions		MACHINING TYPE	
NEW New/Product expansion		 Roughing	
APPLICATION		TOOL MATERIAL	
 Face milling		 Medium cutting	
 Chamfer milling		 Light cutting	
 Shoulder milling with R		 Pre-finishing	
 Face milling close to a wall		 Finishing	
 Shoulder milling		 Fine-finishing	
 Side milling		 UWC Ultra micro grain carbide substrate material.	
 Slot milling		 CBN Mitsubishi Materials' original CBN material.	
 Ramping		 CERAMIC Ceramic For high speed efficient machining of super alloys due to the excellent high temperature strength property.	
 Pocket milling		 KHA S High hardness powder metallurgy HSS High hardness powder metallurgy HSS substrate material.	
 Slot milling with R		 HGSS High grade high alloy HSS High grade high alloy HSS substrate material.	
 Copy milling		 CO HSS Cobalt high speed steel Cobalt high speed steel substrate material.	
 T-Slot milling		 HSS High speed steel High speed steel substrate material.	

COATING



SMART MIRACLE Coating

New smooth and dense coating technology for high efficiency milling of difficult to cut materials.



CRN Coating

Newly developed CrN coating for Copper Electrodes machining.



Violet Coating

Increased tool life of 2-3 times more than TiN coated products.



DP Coating

New generation coating suitable for a wide range of materials.



MIRACLE Coating

The original Miracle (Al,Ti)N coating. Also suitable for dry cutting.



[Al, Ti]N Coating

[Al,Ti]N highly versatile application range.



[Al,Ti,Cr]N multi-layer Coating

For carbon, alloy and hardened steels.



IMPACT MIRACLE Coating

Single phase nano crystal coating technology has higher film hardness and heat resistance.



MIRACLE Coating

The original MIRACLE (Al,Ti)N coating. Also suitable for dry cutting.



VFR Coating

The (AlCrSi)N/(AlTiSi)N PVD multilayer coating is ideal for machining of extremely hard materials up to 70 HRC.



DLC Coating

Hardness similar to CVD diamond coating achieved with high adhesion strength.



Diamond Coating

Suitable for CFRP and CFRP-aluminium materials.



Diamond Coating

Suitable for graphite machining.



Diamond Coating

The original CVD diamond coating.



CVD Diamond Coating

Unique multi-layer micro-grain diamond crystal control technology drastically improves wear resistance and smoothness.

CUTTING EDGE PROPERTIES



Sharp corner edge

Indicates the end mill has a sharp corner edge.



Gash land

Indicates the end mill cutting edge has a protective chamfer.



Rake angle



Helix angle

Indicates the helix angle of the end mill.



Point angle

Indicates the drill point angle.



Roughing flute geometry



Variable helix



Rounded gash



Corner angle

WEB THINNING



X type point geometry

X web thinning used at the drill point.



XR type point geometry

XR web thinning used at the drill point.



S type point geometry

Easy cutting geometry.



N type point geometry

Effective when the point web is thick.



Chipbreaker

SYMBOLS

TOLERANCES



Tolerance of taper angle
Indicates the tolerance of the taper angle.



R tolerance
Indicates the radial tolerance of a ball nose end mill.



R tolerance
Indicates the radial tolerance of the corner radius.



R tolerance
Indicates the radial tolerance of a cutter with a corner radius.



Outside diameter tolerance
Indicates the diameter tolerance of the end mill.



Peak tolerance
Indicates the tolerance for the end diameter.



Shank diameter tolerance



Shank diameter tolerance



Drill tolerance / diameter

COOLANT HOLES



External coolant



Internal coolant



Internal coolant



Centered, internal coolant hole



Radial, internal coolant holes



Internal coolant holes



Internal coolant holes

EUROPEAN SALES COMPANIES

GERMANY

MMC HARTMETALL GMBH
Comeniusstr. 2 . 40670 Meerbusch
Phone +49 2159 91890 . Fax +49 2159 918966
Email admin@mmchg.de

U.K.

MMC HARDMETAL U.K. LTD.
Mitsubishi House . Galena Close . Tamworth . Staffs. B77 4AS
Phone +44 1827 312312
Email sales@mitsubishicarbide.co.uk

SPAIN

MITSUBISHI MATERIALS ESPAÑA, S.A.
Calle Emperador 2 . 46136 Museros/Valencia
Phone +34 96 1441711 . Fax +34 96 1443786
Email comercial@mmevalencia.es

FRANCE

MMC METAL FRANCE S.A.R.L.
6, Rue Jacques Monod . 91400 Orsay
Phone +33 1 69 35 53 53 . Fax +33 1 69 35 53 50
Email mmfsales@mmc-metal-france.fr

POLAND

MMC HARDMETAL POLAND SP. Z O.O
Al. Armii Krajowej 61 . 50 - 541 Wrocław
Phone +48 71335 1620 . Fax +48 71335 1621
Email sales@mitsubishicarbide.com.pl

ITALY

MMC ITALIA S.R.L.
Viale Certosa 144 . 20156 Milano
Phone +39 0293 77031 . Fax +39 0293 589093
Email info@mmc-italia.it

TURKEY

MMC HARTMETALL GMBH ALMANYA - İZMİR MERKEZ ŞUBESİ
Adalet Mahallesi Anadolu Caddesi No: 41-1 . 15001 35530 Bayraklı/İzmir
Phone +90 232 5015000 . Fax +90 232 5015007
Email info@mmchg.com.tr

www.mmc-carbide.com

Order code: N035E 

Published by: MMC Hartmetall GmbH – A Sales Company of  MITSUBISHI MATERIALS | 2024.04 - V2 (2.0 DS), Printed in Germany